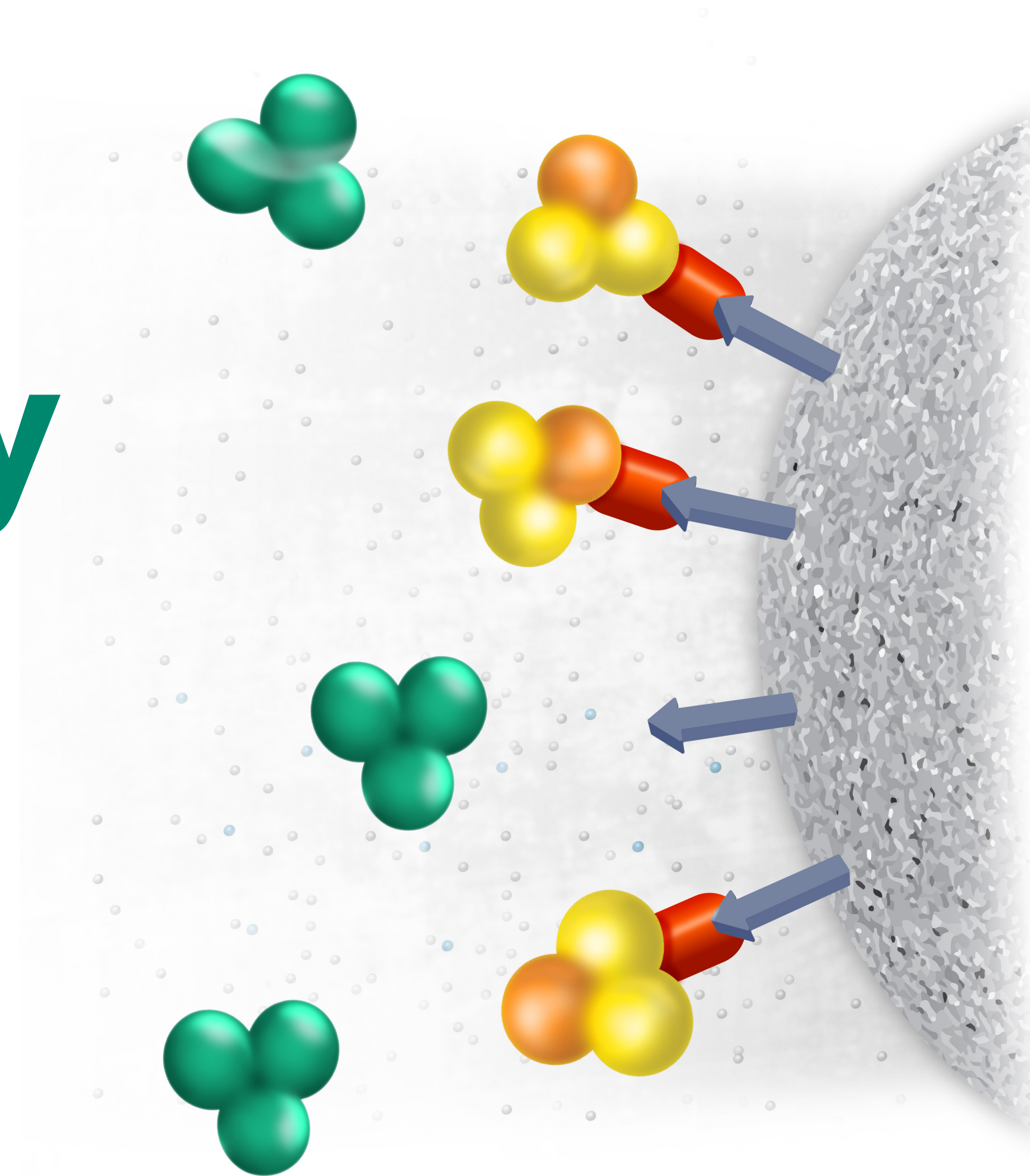


# Affinity Chromatography



# Contents

	<b>Introduction</b>				
	Common acronyms and abbreviations	8			
	Symbols	9			
<b>01</b>	<b>Expression and sample preparation</b>	<b>10</b>			
	Components of the expression system	11			
	• Choice of host	12			
	• Choice of vector	13			
	• Choice of tag	13			
	Sample preparation	16			
	• Cell harvesting and extraction	17			
	• Preparation for chromatographic purification	18			
	• Protein stability	19			
	• Sample clarification	20			
	• Desalting and buffer exchange	21			
	• Detection and quantitation	22			
	• Assessing protein expression	23			
<b>02</b>	<b>Manual and automated purification</b>	<b>26</b>			
	Tagged recombinant proteins for simple purification	26			
	Manual purification techniques	26			
	Selection of purification equipment	28			
<b>03</b>	<b>Purification of histidine-tagged recombinant proteins</b>	<b>29</b>			
	Expression	30			
	Purification overview	31			
	• Imidazole	34			
	• Cell lysis	34			
	• Sample preparation	35			
	Purification using precharged chromatography media	36			
	Purification using Ni Sepharose products	40			
	Purification using Ni Sepharose High Performance	41			
	• Column packing	41			
	• Sample preparation	41			
	• Buffer preparation	42			
	• Purification	42			
	Purification using Ni Sepharose 6 Fast Flow	43			
	• Column packing	43			
	• Sample preparation	43			
	• Buffer preparation	45			
	• Purification	44			
	High-throughput screening using His MultiTrap HP and His MultiTrap FF 96-well filter plates	45			
	• Sample and buffer preparation	45			
	• Centrifugation procedure for high-throughput screening	46			
	• Vacuum procedure for high-throughput screening	47			
	• Vacuum procedure	47			
	• Application example	48			
	Minipreps using His SpinTrap and His SpinTrap Kit	50			
	• Cell lysis	51			
	• Sample and buffer preparation	51			
	• Purification	51			
	• Application example	52			
	Purification using HisTrap HP and HisTrap FF	53			
	• Sample and buffer preparation	53			
	• Purification	54			
	• Application examples	55			
	Purification from unclarified cell lysate using HisTrap FF crude	57			
	• Sample and buffer preparation	58			
	• Purification	58			
	• Application examples	59			
	Manual purification using HisTrap FF crude Kit with a syringe	62			
	• Sample preparation	62			
	• Buffer preparation	63			
	• Standard purification	64			
	• Optimizing purification	65			
	• Application example	66			
	Gravity-flow purification using His GraviTrap and His GraviTrap Kit	67			
	• Sample and buffer preparation	68			
	• Purification	68			
	• Application example	69			
	Condition screening for scaling up using HiScreen Ni FF	70			
	• Sample and buffer preparation	70			
	• Purification	70			
	• Application example	71			
	Preparative purification using HisPrep FF 16/10	72			
	• Sample and buffer preparation	72			
	• Purification	72			
	• Application example	72			
	Magnetic bead-based purification/screening using His Mag Sepharose Ni	73			
	• General magnetic separation steps	74			
	• Dispensing the medium slurry	74			
	• Handling liquids	74			
	• Incubation	74			
	• Sample and buffer preparation	74			
	• Purification	75			
	• Application example	76			
	Purification using Ni Sepharose excel products	76			
	Purification of histidine-tagged proteins secreted into eukaryotic cell culture supernatants using Ni Sepharose excel	77			
	• Column packing	77			
	• Sample preparation	78			
	• Buffer preparation	78			
	• Purification	78			
	Purification of histidine-tagged proteins secreted into eukaryotic cell culture supernatants using HisTrap excel	79			
	• Sample and buffer preparation	80			
	• Purification	80			
	• Application example	81			
	Magnetic bead-based purification of histidine-tagged proteins secreted into eukaryotic cell culture supernatants using His Mag Sepharose excel	82			
	• General magnetic separation steps	82			
	• Dispensing the medium slurry	83			
	• Handling liquids	83			
	• Incubation	83			



• Sample and buffer preparation	83	Purification using HiTrap IMAC HP and HiTrap IMAC FF	104	Purification using Glutathione Sepharose	135
• Purification	83	• Sample and buffer preparation	104	High Performance, Glutathione Sepharose 4 Fast Flow, and Glutathione Sepharose 4B	
• Application example	84	• Charging the column with metal ion	105	• Batch purification of GST-tagged proteins using	136
Purification using TALON Superflow products	85	• Purification	106	Glutathione Sepharose HP, Glutathione Sepharose 4 FF, or Glutathione Sepharose 4B	
Purification using TALON Superflow	85	• Application example	107	• Column purification of GST-tagged proteins using	137
• Sample preparation	86	Condition screening for scaling up using HiScreen IMAC FF	108	Glutathione Sepharose HP, Glutathione Sepharose 4 FF, or Glutathione Sepharose 4B	
• Buffer preparation	86	• Sample and buffer preparation	108	• Column packing	137
• Column packing	86	• Charging the chromatography medium with metal ions	108	• Purification	137
• Purification	87	• Purification	109	High-throughput screening using GST MultiTrap	138
High-throughput screening using His MultiTrap TALON	88	Preparative purification using HiPrep IMAC FF 16/10	110	4B 96-well filter plates	
• Sample and buffer preparation	88	• Sample and buffer preparation	110	• Sample preparation	139
• Purification	88	• Charging the column with metal ion	110	• Buffer preparation	139
Rapid screening using His SpinTrap TALON	91	• Purification	111	• Centrifugation procedure for high-throughput screening	139
• Sample and buffer preparation	92	Detection of histidine-tagged proteins	112	• Centrifugation procedure	140
• Purification	92	Tag removal by enzymatic cleavage	112	Minipreps using GST SpinTrap	142
Manual purification using His GraviTrap TALON	93	• Application example	114	• Sample preparation	143
• Sample and buffer preparation	93	Troubleshooting	114	• Buffer preparation	143
• Purification	93			• Purification	143
• Application example	94			Gravity-flow purification using GST GraviTrap	144
Purification using HiTrap TALON crude	95			• Sample preparation	144
• Sample and buffer preparation	95	<b>04 Optimizing purification of histidine-tagged proteins</b>	<b>117</b>	• Buffer preparation	144
• Purification	95	Optimizing using imidazole	118	• Purification	144
• Application example	96	Optimizing using different metal ions	120	Gravity-flow purification using GST GraviTrap	144
Purification using uncharged chromatography media	97	Optimizing using multistep purifications	123	• Sample preparation	144
Purification using IMAC Sepharose High Performance	98			• Buffer preparation	144
• Packing a column	99	<b>05 Purification of GST-tagged recombinant proteins</b>	<b>129</b>	• Purification	144
• Sample preparation	99	Expression	130	Purification using GSTrap HP, GSTrap FF, and GSTrap 4B columns	145
• Buffer preparation	99	• pGEX vectors	130	• Sample preparation	146
• Charging the chromatography medium with metal ion	99	• The host	131	• Buffer preparation	146
• Purification	100	• Insert DNA	131	• Purification	147
Purification using IMAC Sepharose 6 Fast Flow	101	• Optimizing expression	131	• Application examples	148
• Packing a column	101	Purification	132	Preparative purification using GSTPrep FF 16/10 column	151
• Sample preparation	101	General considerations for purification of	133	• Sample preparation	151
• Buffer preparation	102	GST-tagged proteins		• Buffer preparation	151
• Charging the chromatography medium with metal ion	102	Selecting equipment for purification	134	• Purification	152
• Purification	103			• Application example	153

	Troubleshooting of purification methods	155						
	Detection of GST-tagged proteins	158						
	• GST Detection Module with CDNB enzymatic assay	158						
	• Western blot	159						
	Troubleshooting of detection methods	160						
	Removal of GST tag by enzymatic cleavage	162						
	• Cleavage and purification of GST-tagged protein bound to GSTrap FF	164						
	• Application examples	166						
	• 1. Purification of human hippocalcin using GSTrap FF columns in series with on-column cleavage by PreScission Protease	166						
	• Cleavage and purification of GST-tagged protein eluted from GSTrap FF	170						
	• Cleavage and purification of GST-tagged protein bound to Glutathione Sepharose in batch mode	171						
	• Removal of thrombin and Factor Xa using HiTrap Benzamidine FF (high sub)	173						
	Troubleshooting of cleavage methods	174						
<b>06</b>	<b>Purification of MBP-tagged recombinant proteins</b>	<b>177</b>	<b>07</b>	<b>Purification of <i>Strep</i>-tag II recombinant proteins</b>	<b>187</b>	<b>11</b>	<b>Desalting/buffer exchange and concentration</b>	<b>214</b>
	Purification using Dextrin Sepharose High Performance	177		Purification using StrepTactin Sepharose High Performance	187		General considerations	215
	• Column packing	178		• Column packing	188		• Desalting larger sample volumes using HiTrap and HiPrep columns	215
	• Sample preparation	178		• Sample preparation	188		• Buffer preparation	215
	• Buffer preparation	178		• Buffer preparation	188		• Sample preparation	215
	• Purification	178		• Purification	188		• Buffer exchange	216
	Purification using MBPTrap HP columns	179		Purification using StrepTrap HP 1 mL and 5 mL	189		Small-scale desalting and buffer exchange with PD desalting columns	216
	• Sample preparation	179		• Sample preparation	189		• PD SpinTrap G-25	216
	• Buffer preparation	179		• Buffer preparation	189		• PD MultiTrap G-25	218
	• Purification	180		• Purification	190		• PD MiniTrap G-25 and PD MidiTrap G-25	220
	• Application examples	181		• Application examples	190		• PD-10 Desalting columns	222
	• 1. Automated two-step purification on ÄKTAexpress	181		• Individual HisTrap HP purification	191		• PD MiniTrap G-10 and PD MidiTrap G-10	224
	• 2. Purification of a protein involved in metabolic disease	182		• Individual StrepTrap HP purification	191		HiTrap Desalting columns	226
	• 3. Scaling up	183		• Two-step HisTrap HP and StrepTrap HP purification	191		Scaling up desalting from HiTrap to HiPrep Desalting Protein sample concentration	228
			<b>08</b>	<b>Purification of protein A-tagged proteins</b>	<b>195</b>	<b>12</b>	<b>Appendix</b>	<b>230</b>
				Performing a separation using IgG Sepharose 6 Fast Flow	196		<b>Appendix 1</b>	<b>231</b>
				• Buffer preparation	196		<b>Characteristics of Ni Sepharose, Ni Sepharose excel, TALON Superflow, and uncharged IMAC Sepharose products</b>	<b>231</b>
				• Application example	197		Ni Sepharose products	231
				• Chemical stability	197		Stripping, recharging, and cleaning of Ni Sepharose products	235
				• Storage	197		• Stripping and recharging	235
			<b>09</b>	<b>Affinity chromatography in a purification strategy (CIPP)</b>	<b>199</b>		• Cleaning in place	235
				Applying CIPP	200		• To remove ionically bound protein	235
				Selection and combination of purification techniques	200		• To remove precipitated proteins, hydrophobically bound proteins, and lipoproteins	235
			<b>10</b>	<b>Handling inclusion bodies</b>	<b>204</b>		• To remove hydrophobically bound proteins, lipoproteins, and lipids	235
				• Optimizing for soluble expression	205		Ni Sepharose excel/His Mag Sepharose excel products	236
				• Solubilizing inclusion bodies	206			
				• Refolding of solubilized recombinant proteins	207			
				• Analysis of correctly folded proteins	208			
				• Application	208			
				• Screening conditions for refolding using IMAC	210			



Cleaning of Ni Sepharose excel products	237
• Cleaning in place	237
• To remove ionically bound proteins	237
• To remove precipitated proteins, hydrophobically bound proteins, and lipoproteins	237
• To remove hydrophobically bound proteins, lipoproteins, and lipids	237
TALON Superflow products	238
Stripping, recharging, and cleaning of TALON Superflow products	240
• Stripping and recharging	240
Uncharged IMAC Sepharose products	241
Stripping, recharging, and cleaning of IMAC Sepharose products	243
• Stripping and recharging	243
• Cleaning in place	244
• To remove ionically bound protein	244
• To remove precipitated proteins, hydrophobically bound proteins, and lipoproteins	244
• To remove hydrophobically bound proteins, lipoproteins, and lipids	244
<b>Appendix 2</b>	
<b>Characteristics of Glutathione Sepharose products</b>	<b>245</b>
<b>Appendix 3</b>	
<b>Characteristics of Dextrin Sepharose High Performance products</b>	<b>248</b>
Cleaning of Dextrin Sepharose products	249
<b>Appendix 4</b>	
<b>Characteristics of StrepTactin Sepharose High Performance products</b>	<b>250</b>
Regeneration and cleaning of StrepTactin Sepharose High Performance	252
Regeneration and cleaning of StrepTrap HP 1 mL and 5 mL	252

<b>Appendix 5</b>	
<b>Precipitation and resolubilization</b>	<b>253</b>
Fractional precipitation	253
Ammonium sulfate precipitation	254
• Solutions needed for precipitation	255
<b>Appendix 6</b>	
<b>Column packing and preparation</b>	<b>257</b>
Column packing and efficiency	259
• Custom column packing	259
<b>Appendix 7</b>	
<b>Conversion data</b>	<b>260</b>
Proteins	260
Column pressures	260
<b>Appendix 8</b>	
<b>Converting from flow velocity to volumetric flow rates</b>	<b>261</b>
From flow velocity (cm/h) to volumetric flow rate (mL/min)	261
From volumetric flow rate (mL/min) to flow velocity (cm/h)	261
From volumetric flow rate (mL/min) to using a syringe	261
<b>Appendix 9</b>	
<b>GST vectors</b>	<b>262</b>
<b>Appendix 10</b>	
<b>Table of amino acids</b>	<b>263</b>
<b>Appendix 11</b>	
<b>Principles and standard conditions for different purification techniques</b>	<b>264</b>
Affinity chromatography (AC)	264
Ion exchange chromatography (IEX)	265
• Method development (in priority order)	266
Hydrophobic interaction chromatography (HIC)	266
• Method development (in priority order)	267
Size exclusion chromatography (SEC)	268
Reversed phase chromatography (RPC)	269
• Method development	269

<b>Appendix 12</b>	
<b>Tables for Vivaspin sample concentrators</b>	<b>270</b>
<b>Product index</b>	<b>272</b>
<b>Related literature</b>	<b>274</b>
<b>Ordering information</b>	<b>275</b>

## Principles and methodology handbooks from Cytiva

Cytiva offers a wide range of handbooks that provides practical tips and in-depth information about common methodologies used in the lab. Visit [cytiva.com/handbooks](https://www.cytiva.com/handbooks) to view the complete list and download your copies today.

# Introduction

This handbook is intended for those interested in the expression and purification of recombinant proteins. The use of recombinant proteins has increased greatly in recent years, as has the wealth of techniques and products used for their expression and purification. The advantages of using a protein/peptide tag fused to the recombinant protein to facilitate its purification and detection are now widely recognized. In some cases, tags may improve the stability and solubility of recombinant proteins.



The reader will be introduced to the initial considerations to be made when deciding upon host, vector, and use of a tagged or untagged protein. General guidelines for successful protein expression are also included. Advice is given on harvesting and extraction, handling of inclusion bodies, tag removal, and removal of unwanted salts and small molecules.

Purification of recombinant proteins can be performed manually or by using a chromatography system. The system can be operated manually, or it can be automated to save time and effort. The purification can be performed on many scales, in columns of various sizes. Columns can be purchased prepacked with a chromatographic medium, or empty columns can be packed manually. Purification can also be performed in batch, with gravity flow or centrifugation, in SpinTrap™ columns using centrifugation, in a 96-well plate format using MultiTrap™ products, or with magnetic beads using Mag Sepharose™ products.

Proteins are purified using chromatography techniques that separate them according to differences in their specific properties. Tags enable recombinant proteins to be purified by affinity chromatography (AC) designed to capture the tagged recombinant protein based on biorecognition of the tag. Thus, the same purification platform can be used for different recombinant proteins. In the same way, tags also allow the use of a common detection protocol for different recombinant proteins. Consequently, tagged proteins are simple and convenient to work with and, for many applications, a single purification step, using a commercially available chromatography column, is sufficient. This is clearly demonstrated in the specific chapters on the expression, purification, and detection of recombinant proteins fused with the commonly used histidine, glutathione S-transferase (GST), maltose binding protein (MBP), or *Strep-tag*™ II tags. A scheme for the general purification of histidine-tagged proteins is given in Figure 1.1. In addition, suggestions for the successful purification of untagged recombinant proteins by a single AC step are also given in this handbook. When a higher degree of purity is required for either tagged or untagged recombinant proteins, a multistep purification will be necessary. This can become a straightforward task by choosing the right combination of purification techniques.

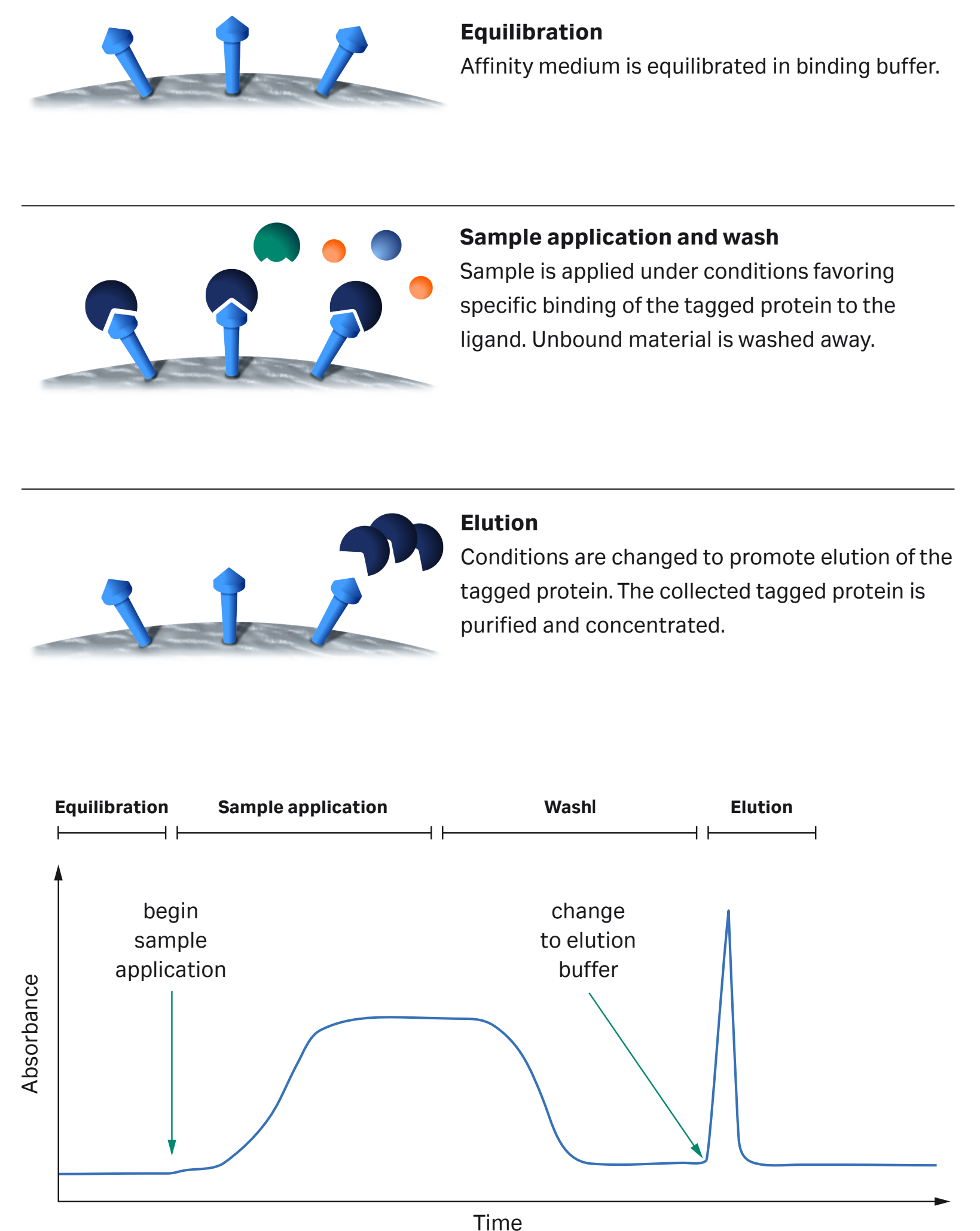
In summary, this handbook aims to help the reader achieve a protein preparation that contains the recombinant protein of interest in the desired quantity and quality required for their particular needs. The quality of the recombinant protein can be reflected in its folding and biological activity.

This handbook is volume 2 in a series of three volumes covering aspects of the purification of proteins by affinity chromatography (AC). The three volumes are:

*Affinity Chromatography, Vol. 1: Antibodies*

*Affinity Chromatography, Vol. 2: Tagged Proteins*

*Affinity Chromatography, Vol. 3: Specific Groups of Biomolecules*



**Fig 1.1.** General affinity purification workflow of tagged recombinant proteins.

# Common acronyms and abbreviations

$A_{280}$	UV absorbance at specified wavelength (in this example, 280 nanometers)	HIC	hydrophobic interaction chromatography	PVDF	polyvinylidene fluoride
AC	affinity chromatography	HMW	high molecular weight	r	recombinant, as in rGST and rBCA
BCA	bicinchoninic acid	HP	High Performance	RNase	ribonuclease
CDNB	1-chloro-2,4-dinitrobenzene	HRP	horseradish peroxidase	RPC	reverse phase chromatography
CF	chromatofocusing	IEF	isoelectric focusing	SEC	size exclusion chromatography (also known as gel filtration, GF)
CHO	Chinese hamster ovary	IEX	ion exchange chromatography	SDS	sodium dodecyl sulfate
CIP	cleaning-in-place	IMAC	immobilized metal ion affinity chromatography	SDS-PAGE	sodium dodecyl sulfate polyacrylamide gel electrophoresis
CIPP	capture, intermediate purification, and polishing	IPTG	isopropyl $\beta$ -D-thiogalactoside	TCEP	Tris(2-carboxyethyl)phosphine hydrochloride
CV	column volume	LMW	low molecular weight	TEV	tobacco etch virus
DAB	3,3'-diaminobenzidine	MBP	maltose binding protein	TMB	3, 3',5,5'-tetramethyl benzidine
DNase	deoxyribonuclease	MPa	megaPascal		
DOE	design of experiments	$M_r$	relative molecular weight		
DTE	dithioerythritol	MWCO	molecular weight cutoff		
DTT	dithiothreitol	NTA	nitrilotriacetic acid		
ELISA	enzyme-linked immunosorbent assay	N/m	column efficiency expressed as theoretical plates per meter		
FF	Fast Flow	PBS	phosphate buffered saline		
Gua-HCl	guanidine-HCl	pI	isoelectric point, the pH at which a protein has zero net surface charge		
GF	gel filtration (also known as size exclusion chromatography, SEC)	psi	pounds per square inch		
GST	glutathione S-transferase	PMSF	phenylmethylsulfonyl fluoride		



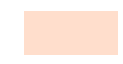
# Symbols



This symbol indicates general advice on how to improve procedures or recommends measures to take in specific situations



This symbol indicates where special care should be taken



Highlights chemicals, buffers, and equipment



Outline of experimental protocol

01

# Expression and sample preparation



## Components of the expression system

A protein expression system includes, among other things, a vector with an appropriate promoter and other regulatory sequences, along with the gene encoding the recombinant protein of interest. Vectors are available commercially for the expression of recombinant proteins either fused to a tag or untagged. Such expression vectors are designed with control regions to suit the specific host (for example, *E. coli* versus mammalian cells) and type of expression needed. The presence of resistance markers makes selection of the correct clones more straightforward. Expression of the recombinant protein can be constitutive or regulated, or it can be at a high or low level, depending on the specific requirements. The choice of vector is important because it affects so many of the processes that follow the cloning steps including expression, protein processing, and purification. The completed vector construct is used in a prokaryotic or eukaryotic organism, tissue, or cell line to produce the recombinant protein that may be of academic and/or industrial importance. The recombinant protein may then need to be detected, quantitated, and/or purified. Selection of a suitable expression system depends on the desired scale of production, the time and resources available, and the intended use of the recombinant protein. Several alternative systems for expression may be suitable.

## Choice of host

Many host systems are available including bacteria, yeast, plants, filamentous fungi, insect or mammalian cells grown in culture, and transgenic animals or plants. Each host system has its own advantages and disadvantages, and it is important to consider these before final selection of host.

The choice of host affects not only the expression of the protein but also the way in which the product can be subsequently purified. In order to decide which host is most suitable, the amount and the degree of purity of the product, as well as its biological integrity and potential toxicity, should be considered. For example, bacterial expression systems are not suitable if post-translational modification is required to produce a fully functional recombinant product. Table 1.1 summarizes features of several expression systems.

**Table 1.1.** Features of several types of expression systems

Processing	Bacteria	Yeast	Insect cells	Mammalian cells
Inclusion bodies	+/-	(+)/-	-	-
Secretion	+/-	+ <sup>1</sup>	+	+
Glycosylation	-	+ <sup>2</sup>	+	+
Proteolytic cleavage	+/-	+/-	-	-
Other post translational modifications	-	+ <sup>3</sup>	+	+

+ Yes

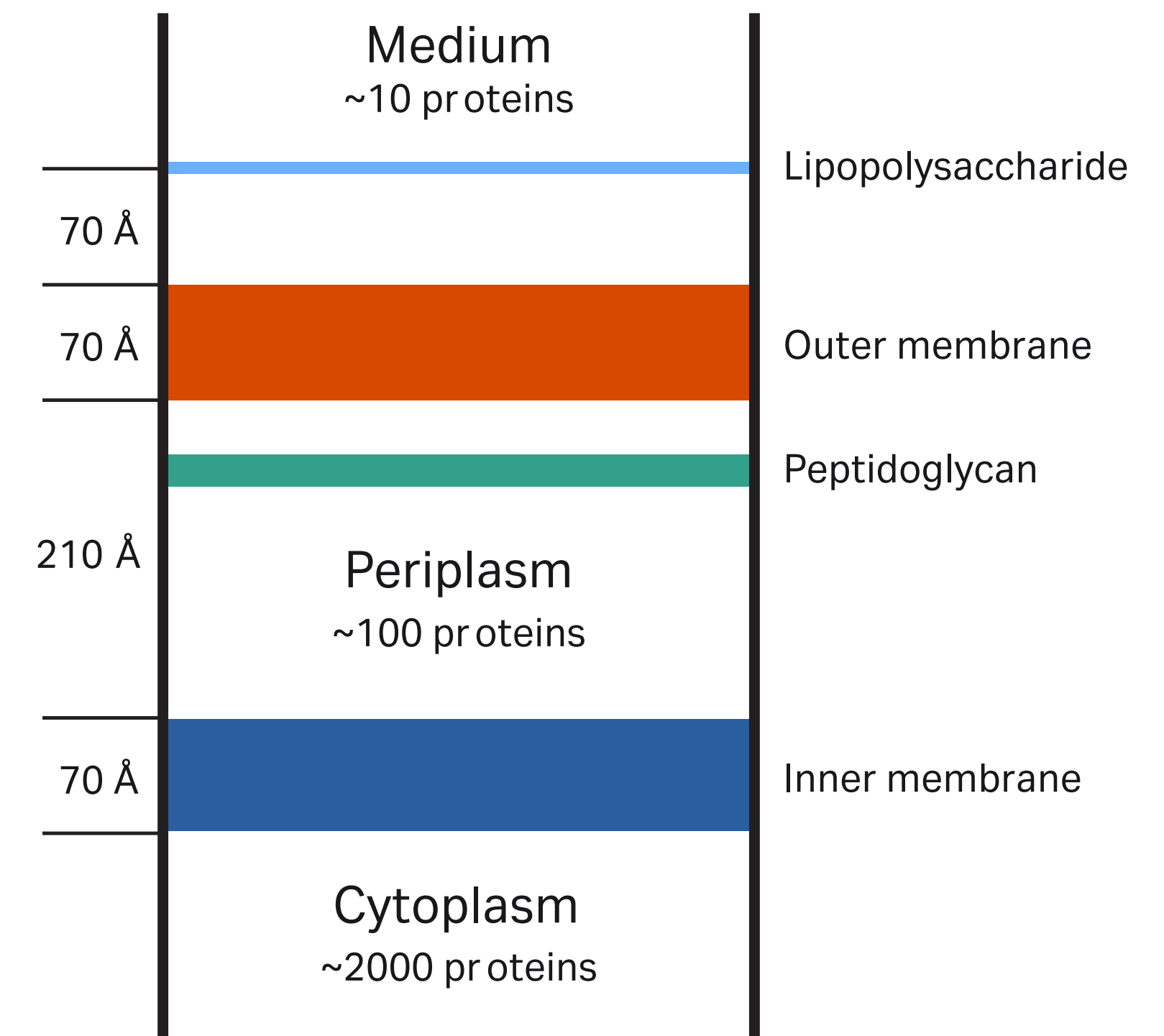
- No

<sup>1</sup> Constructs are often prepared to allow secretion of the protein. This eliminates the need for cell lysis, which requires more powerful methods for yeast than for *E. coli*.

<sup>2</sup> Yeast give more extensive glycosylation than insect cells and mammalian cells; this is a drawback of heterologous expression in yeast.

<sup>3</sup> Yeast lack some functions of post-translational modifications that exist in higher eukaryotes.

The location of product within the host will affect the choice of methods for isolation and purification of the product. For example, in addition to expressing the protein cytoplasmically, a bacterial host may secrete the protein into the culture medium, transport it to the periplasmic space, or store it as insoluble inclusion bodies within the cytoplasm (Fig 1.1). Expression in different parts of the cell will lead to varying amounts of cellular (contaminant) proteins that will need to be removed to obtain a pure target protein. Secretion into the culture medium gives the advantage of fewer contaminating cellular proteins, but other components in the culture medium, such as EDTA, may cause nickel stripping from immobilized metal ion affinity chromatography (IMAC) media. Ni Sepharose excel has exceptionally strongly bound nickel ions and is especially designed for purification of secreted histidine-tagged proteins from eukaryotic cell culture supernatants.



**Fig 1.1.** Schematic cross-section of the cell wall and typical number of protein species in *E. coli*.

The main focus of this handbook is purification of soluble proteins from bacterial sources, as these are the most common systems, but purification of secreted proteins from eukaryotic cells is also included (see Chapter 3). Purification of proteins expressed as inclusion bodies is also discussed (see Chapter 10).

## Choice of vector

The choice of vector family is largely governed by the host. Once the host has been selected, many different vectors are available for consideration, from simple expression vectors to those that contain specialized sequences needed to secrete the recombinant proteins. In order to clone the gene of interest, all engineered vectors have a selection of unique restriction sites downstream of a transcription promoter sequence. Recent developments in cloning technology provide increased flexibility in the choice of host and vector systems, including options allowing the DNA sequence of interest to be inserted into multiple types of expression vectors.

The expression of a recombinant protein fused to a tag of known size and biological function can greatly simplify subsequent purification and detection (for expression method development and purification). In some cases, the protein yield can also be increased. Table 1.2 reviews some of the features of tagged protein expression, purification, and detection that may influence the final choice of vector.

## Choice of tag

There are several affinity tags that can be used to simplify protein purification. The choice of tag may depend on many different factors. The most common tag, the histidine tag, is often a (histidine)<sub>6</sub>, but other polyhistidine tags consisting of between four and 10 histidine residues have been used. The latter provides for the strongest affinity for the chromatography medium. Other important tags are the GST and MBP tags, both of which are proteins, and *Strep*-tag II, which is a peptide optimized for chromatography on *Strep*-Tactin™ based chromatography media. Table 1.3 on the following two pages highlights some key features of these tags.

Cytiva provides a variety of solutions for purification of histidine-, GST-, MBP-, and *Strep*-tag II-tagged proteins. Chapters 3, 5, 6, and 7, respectively, discuss these solutions in detail. Cytiva provides purification solutions for other tagged proteins as well, including the calmodulin-binding peptide, the protein A tag, biotinylated peptide tags, and immunoglobulin F<sub>c</sub> domain tags. Recombinant proteins fused to the calmodulin-binding peptide can be purified by Calmodulin Sepharose 4B. Protein A-tagged proteins can be purified using IgG Sepharose Fast Flow. Recombinant proteins with a biotinylated peptide tag can be purified using HiTrap™ Streptavidin HP columns, or Streptavidin Sepharose High Performance. Immunoglobulin F<sub>c</sub> domain-tagged proteins can be purified with different Protein A Sepharose or Protein G Sepharose chromatography media.

The purification of biomolecules using Calmodulin Sepharose 4B and Streptavidin Sepharose High Performance is covered in greater detail in the Cytiva handbook *Affinity Chromatography, Vol. 3: Specific Groups of Biomolecules*, 18102229.

**Table 1.2.** Advantages and disadvantages of tagged versus untagged protein expression

### Advantages

### Disadvantages

#### Tagged proteins

Simple purification is possible using AC. Generic two-step purification protocols can often be set up for lab-scale protein production platforms.

Detection of the tag instead of the target protein moiety allows for a generic detection method in, e.g., protein production platforms for structural biology

Solubility and stability can be improved

Targeting information can be incorporated into a tag

A marker for expression is provided

Some tags allow strong binding to chromatography media in the presence of denaturants, making on-column refolding possible

Tag may interfere with protein structure and affect folding and biological activity

If tag needs to be removed, cleavage may not always be achieved at 100%, and sometimes amino acids may be left<sup>1</sup>

#### Untagged proteins

Tag removal is not necessary

Purification and detection not as simple

Problems with solubility and stability may be difficult to overcome, reducing potential yield

<sup>1</sup> The effectiveness of proteases used for cleavage may be decreased by substances, for example, detergents, in the protein preparation or by inappropriate conditions.



**Table 1.3.** Characteristics of affinity tags

Tag-specific characteristics	Histidine tag	GST tag	MBP tag	Strep-tag II
Compatible expression systems	Can be used in any expression system	Can be used in any expression system	Can be used in any expression system	Can be used in any expression system
Metabolic burden to host	Low metabolic burden to expression host	High metabolic burden to expression host	High metabolic burden to expression host	Low metabolic burden to expression host
Yield after purification	Purification procedure gives high yields	Purification procedure gives high yields	Purification procedure gives high yields	Purification procedure gives high yields
Purity in a single step	Allows relatively high purity in a single purification step. Optimization of washing and elution conditions is recommended when extra high purity is needed in a single step.	Allows extremely high purity in a single purification step	Allows extremely high purity in a single purification step	Allows extremely high purity in a single purification step
Effect on solubility of expressed protein	Does not enhance solubility.	May increase the solubility of the expressed protein	May increase the solubility of the expressed protein	Does not enhance solubility
Purification products for different scales	Selection of purification products available for any scale	Selection of purification products available for any scale	Selection of purification products available for any scale	Selection of purification products available for any scale
Affinity tag removal	Small tag may not need to be removed (e.g., tag is weakly immunogenic so target protein can be used directly as an antigen for immunization). Site-specific proteases <sup>1</sup> enable cleavage of tag if required. Tobacco Etch Virus (TEV) protease is often used to cleave off histidine tags. Note: Enterokinase sites that enable tag cleavage without leaving behind extra amino acids are preferable.	Site-specific protease (PreScission™ Protease) <sup>1</sup> enables highly specific cleavage at 4°C. This protease is also easily removed because it is itself GST-tagged (see Chapter 5).	Protease cleavage site can be engineered into the tagged protein	Small tag may not need to be removed (e.g., tag is weakly immunogenic so the target protein can be used directly as an antigen for immunization)
Tag detection	Histidine tag is easily detected using anti-histidine based immunoassay	GST tag is easily detected using a GST activity assay or anti-GST-based immunoassay	Antibodies for detection available	Antibodies for detection available
Ease of purification	Simple purification. Note: Imidazole may cause precipitation in rare cases. Buffer exchange to remove imidazole may be necessary (see Chapter 11).	Simple purification. Very mild elution conditions minimize risk of damage to structure and function of the target protein. Buffer exchange may be desirable to remove reduced glutathione used for elution (see Chapter 11).	Simple purification. Very mild elution conditions minimize risk of damage to structure and function of the target protein. Buffer exchange may be desirable to remove maltose used for elution (see Chapter 11).	Simple purification. Very mild elution conditions minimize risk of damage to structure and function of the target protein. Buffer exchange may be desirable to remove desthiobiotin used for elution (see Chapter 11).
Elution conditions	Mild elution conditions	Very mild elution conditions	Very mild elution conditions	Very mild elution conditions

Tag-specific characteristics	Histidine tag	GST tag	MBP tag	Strep-tag II
Suitability for dual tagging	Can be used for dual tagging to increase purity and to secure full-length polypeptides if the tags are placed at the N- and C-terminals  Dual tagging in combination with <i>Strep</i> -tag II minimizes effects on the target protein due to the small size of both tags	Can be used for dual tagging to increase purity and to secure full-length polypeptides if the tags are placed at the N- and C-terminals	Can be used for dual tagging to increase purity and to secure full-length polypeptides if the tags are placed at the N- and C-terminals	Can be used for dual tagging to increase purity and to secure full-length polypeptides if the tags are placed at the N- and C-terminals  Dual tagging in combination with histidine tag minimizes effects on the target protein due to the small size of both tags
Suitability for purification under denaturing conditions	Purification can be performed under denaturing conditions if required. Allows on-column refolding.	Cannot be used under denaturing conditions	Cannot be used under denaturing conditions	Cannot be used under denaturing conditions
Effect on protease action	No effect on protease action	A protein tag may hinder protease action on the target protein	A protein tag may hinder protease action on the target protein	No effect on protease action
Effect on folding	Minimal effect on folding	Believed to promote folding of recombinant proteins	Believed to promote folding of recombinant proteins	Minimal effect on folding
Effect on structure and function of fusion partner	Small tag is less likely to interfere with structure and function of fusion partner	Tagged proteins form dimers via the GST tag. A protein tag may interfere with structure and function of the target protein.	A protein tag may interfere with structure and function of the target protein	Small tag is less likely to interfere with structure and function of fusion partner
Effect on crystallization	Less risk of effects on crystallization than for large tags. May allow crystallization via coordination to Ni <sup>2+</sup> ions	May interfere with crystallization due to increased flexibility of the tagged protein. Removal of tag after purification may be needed. Crystals have been obtained in a few cases by using extra-short spacers between the tag and target protein.	May interfere with crystallization due to increased flexibility of the tagged protein. Removal of tag after purification may be needed. Crystals have been obtained in a few cases by using extra-short spacers between the tag and target protein.	Less risk of effects on crystallization than for large tags
Suitability for purification of protein complexes	The tag will have a minimal effect on protein complex synthesis and will allow preparative purification of stable complexes provided that additional purification steps can be added for final purity	Suitable for protein complex purification requiring extremely mild wash and elution conditions	Suitable for protein complex purification requiring extremely mild wash and elution conditions	Suitable for protein complex purification requiring extremely mild wash and elution conditions
Suitability for purification of proteins containing metal ions	Generally, not recommended for purification of proteins that contain metal ions	Can be used for metal-containing proteins	Can be used for metal-containing proteins	Can be used for metal-containing proteins

<sup>1</sup> The effectiveness of proteases used for cleavage may be decreased by substances, for example, detergents, in the protein preparation or by inappropriate conditions.

## Sample preparation

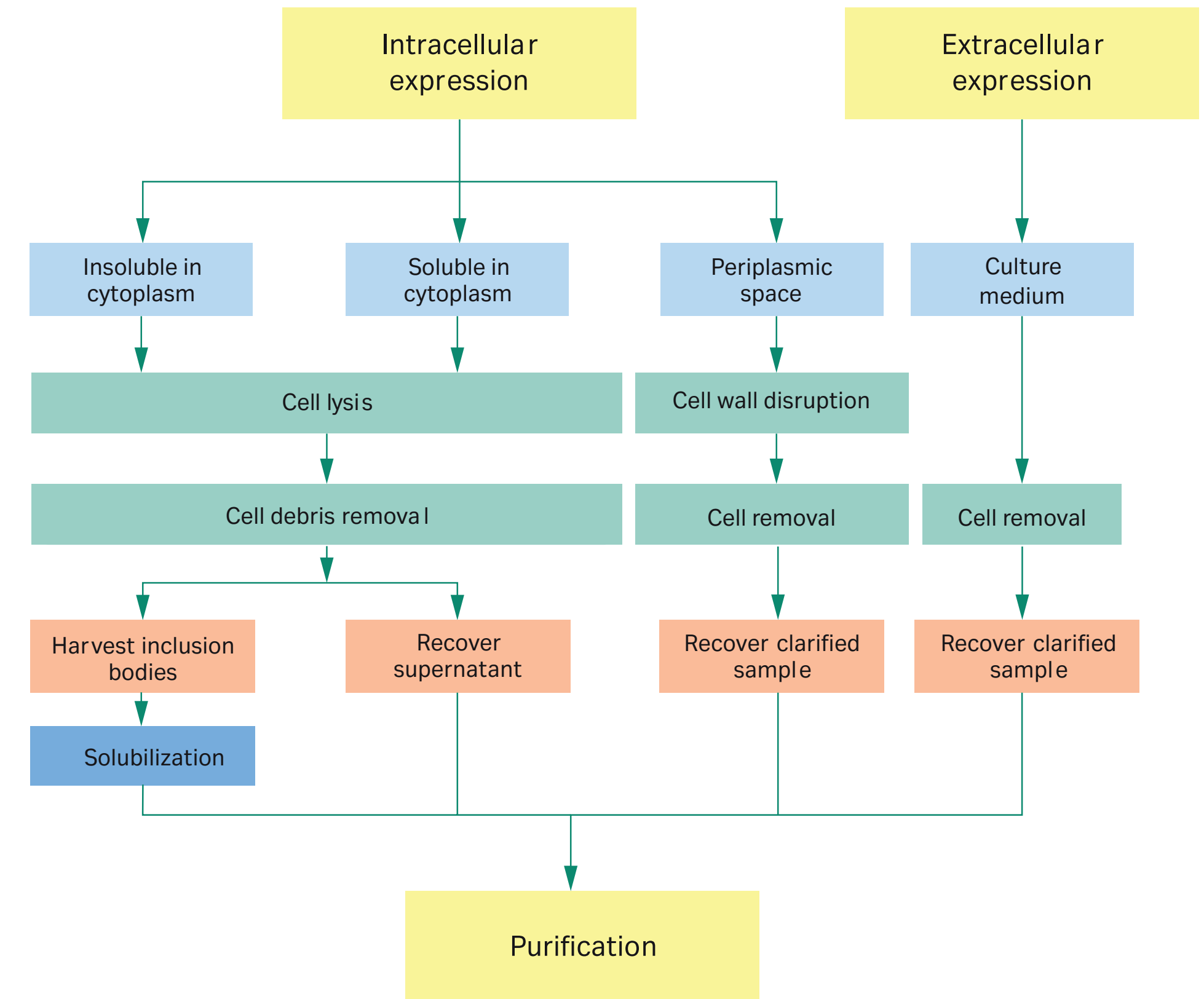
The key to optimizing expression of tagged proteins is the capability to screen crude lysates from many clones so that optimal expression levels and growth conditions can be readily determined. This can easily be accomplished using the prepacked 96-well plates, TALON® MultiTrap, His MultiTrap HP, and His MultiTrap FF, or GST MultiTrap 4B (see Chapters 3 and 5, respectively). Once conditions are established, the researcher is ready to prepare large-scale cultures of the desired clones. The samples are then processed and prepared for purification. Various methods for the purification of tagged proteins are available, depending on the expression system (host and vector) and the tag used. An overview of the sample preparation process is depicted in Figure 1.2.

For specific sample preparation steps, see Chapter 3 for histidine-tagged proteins, Chapter 5 for GST-tagged proteins, Chapter 6 for MBP-tagged proteins, and Chapter 7 for *Strep*-tag II proteins.

Yield of recombinant proteins is highly variable and is affected by the nature of the tagged protein, the host cell, and the culture conditions. Recombinant protein yields can range from 0 to 10 mg/l. Table 1.4 can be used to approximate culture volumes based on an average yield of 2.5 mg/l.

**Table 1.4.** Recombinant protein yields

Protein yield	12.5 µg	50 µg	1 mg	10 mg	50 mg
Culture volume	5 mL	20 mL	400 mL	4 L	20 L
Volume of lysate	0.5 mL	1 mL	20 mL	200 mL	1000 mL



**Fig 1.2.** Overview of sample preparation.








## Cell harvesting and extraction

Cell harvesting and extraction procedures should be selected according to the source of the protein, such as bacterial, plant, or mammalian, intracellular or extracellular. Harvesting, in which the cells are separated from the cell culture media, generally involves either centrifugation or filtration. Refer to standard protocols for the appropriate methodology based on the source of the target protein.

Selection of an extraction technique depends as much on the equipment available and scale of operation as on the type of sample. Examples of common extraction processes for recombinant proteins are shown in Table 1.5. In many situations, researchers may select a combination of these methods to achieve optimal results.

The results obtained from cell lysis depend on several factors, including sample volume, cell concentration, time, temperature, energy input (speed of agitation, pressure, etc.), and physical properties of the cell lysis device.

-  Use procedures that are as gentle as possible because too vigorous cell or tissue disruption may denature the target protein or lead to the release of proteolytic enzymes and general acidification.
-  Extraction should be performed quickly, at sub-ambient temperatures, in the presence of a suitable buffer to maintain pH and ionic strength and stabilize the sample.
-  Add protease inhibitors before cell disruption.
-  The release of nucleic acids may cause viscosity problems (addition of DNase may decrease viscosity). Frequently, protease inhibitors are needed to reduce protein breakdown during extraction. Fractional precipitation (see Appendix 5) may reduce the presence of proteases.
-  In bacterial and yeast expression systems, the recombinant protein may often be contained in inclusion bodies. Extraction requires solubilization of the inclusion bodies, usually in the presence of denaturants, followed by refolding before or after purification. Refer to Chapter 10 for more information.

**Table 1.5.** Common sample extraction processes for recombinant proteins

Extraction process	Typical conditions	Comment
<b>Gentle</b>		
Cell lysis (osmotic shock)	2 volumes water to 1 volume packed prewashed cells	Lower product yield but reduced protease release
Enzymatic digestion	Lysozyme 0.2 mg/mL, 37°C, 15 min.	Lab scale only, often combined with mechanical disruption
<b>Moderate</b>		
Grinding with abrasive, e.g., glass beads	Add glass beads to prewashed cells, vortex, centrifuge, repeat up to five times, pooling supernatants	Physical method. Chemical conditions are less important for cell lysis but may be important for subsequent removal of cell debris and purification steps.
Freeze/thaw	Freeze cells, thaw, resuspend pellet by pipetting or gentle vortexing in room-temperature lysis buffer. Incubate, centrifuge, retain supernatant.	Several cycles
<b>Vigorous</b>		
Ultrasonication or bead milling	Follow equipment instructions	Small scale; release of nucleic acids may cause viscosity problems (may add DNase to decrease viscosity); inclusion bodies must be resolubilized.
Manton-Gaulin homogenizer	Follow equipment instructions	Large scale
French press	Follow equipment instructions	Lab scale
Fractional precipitation	See Appendix 5	Precipitates must be resolubilized

## Preparation for chromatographic purification

Samples for chromatographic purification should be clear and free from particulate matter. Simple steps to clarify a sample before beginning purification will avoid clogging the column, may reduce the need for stringent washing procedures, and can extend the life of the chromatographic medium. An exception to this rule is when purifying a histidine-tagged protein using HisTrap™ FF crude columns , HisTrap FF crude kit, His GraviTrap™ columns, His MultiTrap, HiTrap TALON crude, or HiTrap excel products (all discussed in Chapter 3), or when purifying a GST-tagged protein using GST MultiTrap products (discussed in Chapter 5). Use of any of these products eliminates the need to clarify the sample and will therefore speed up the purification procedure. This may be very important when purifying sensitive proteins, as a means to preserve their activity.

Major parameters to consider when preparing a sample for chromatographic purification include:

- Clarification (except for the products for unclarified samples; see above)
- Stabilization of target protein (protease inhibition, pH, ionic state, reducing agents, stabilizing additives, etc.)
- Conditions for purification to work (mainly adsorption, optimizing binding of target protein, and minimizing binding of contaminants)
- Available equipment
- Practicalities and convenience (sample size, filtration/centrifugation equipment, etc.)

## Protein stability

In the majority of cases, biological activity needs to be retained after purification. Retaining the activity of the target molecule is also an advantage when following the progress of the purification, because detection of the target molecule often relies on its biological activity. Denaturation of sample components often leads to precipitation or enhanced nonspecific adsorption, both of which will impair column function. Hence, there are many advantages to checking the stability limits of the sample and working within these limits during purification.

Proteins generally contain a high degree of tertiary structure, kept together by van der Waals' forces, ionic and hydrophobic interactions, and hydrogen bonding. Any conditions capable of destabilizing these forces may cause denaturation and/or precipitation. By contrast, peptides contain a low degree of tertiary structure. Their native state is dominated by secondary structures, stabilized mainly by hydrogen bonding. For this reason, peptides tolerate a much wider range of conditions than proteins. This basic difference in native structures is also reflected in that proteins are not easily renatured, while peptides often renature spontaneously. Protein quaternary structure and protein complexes may pose additional challenges to a successful protein purification. Protein complexes are often held together by weak interactions that require mild purification conditions, and perhaps removal of incomplete species of the complex. Some proteins require coenzymes or cofactors to be active, and membrane proteins may need lipids from their natural environment in the cell membrane to maintain their native structure.


It is advisable to perform stability tests before beginning to develop a purification protocol. Monitoring aggregate formation with size exclusion chromatography (SEC) provides a useful general stability assay for proteins. The list below may be used as a basis for stability testing. A design-of-experiment approach, in which combinations of conditions are tested, is recommended. Partial factorial design can be used to reduce the number of combinations of conditions to be tested, reducing time and cost.

- Test pH stability in steps of one pH unit between pH 2 and pH 9
- Test salt stability with 0 to 2 M NaCl and 0 to 2 M  $(\text{NH}_4)_2\text{SO}_4$  in steps of 0.5 M (include buffering agents as well)
- Test the temperature stability in 10°C steps from 4°C to 44°C. At a minimum, first test in the cold room and at ambient temperature (22°C)
- Test for protein stability and proteolytic activity by leaving an aliquot of the sample at room temperature overnight. To assay for proteolytic activity, it is advisable to run an SDS-polyacrylamide gel to check the size of the target protein.



## Sample clarification

Centrifugation and filtration are standard laboratory techniques for sample clarification and are used routinely when handling small samples. Keeping samples on ice until use is often recommended, even when purification is performed at room temperature.


 It is highly recommended to centrifuge and filter any sample immediately before chromatographic purification, unless purifying a histidine-tagged protein using HisTrap FF crude columns, HisTrap FF crude kit, His GraviTrap columns, His MultiTrap, HiTrap TALON crude, or HiTrap excel products (all discussed in Chapter 3), or when purifying a GST-tagged protein using GST MultiTrap products (discussed in Chapter 5).

A clarified sample that is not used immediately may within minutes start to precipitate. In this situation, reclarification is recommended.

### Centrifugation

Centrifugation removes most particulate matter, such as cell debris. If the sample is still not clear after centrifugation, use filter paper or a 5 µm filter as a first step and one of the filters listed in Table 1.6 as a second step. Use the cooling function of the centrifuge and precool the rotor by storing it in the cold room (or by starting to cool the centrifuge well in advance with the rotor in place).


 For small sample volumes or proteins that adsorb to filters, centrifuge at 10 000 × g for 15 min.

 For cell lysates, centrifuge at 40 000 to 50 000 × g for 30 min (may be reduced to 10 to 15 min if processing speed is of the essence).

### Filtration

Filtration removes particulate matter. Membrane filters that give the least amount of nonspecific binding of proteins are composed of cellulose acetate or polyvinylidene fluoride (PVDF). For sample preparation before chromatography, select a filter pore size in relation to the bead size of the chromatographic medium as shown in Table 1.6.

 Check the recovery of the target protein in a test run. Some proteins may adsorb nonspecifically to filter surfaces.

 Filters become “saturated” — that is, they have a certain capacity. It may be necessary to check the capacity when setting up a protocol.


**Table 1.6.** Selecting filter pore sizes

Nominal pore size of filter	Particle size of chromatographic medium
1 µm	90 µm and greater
0.45 µm	30 or 34 µm
0.22 µm	3, 10, 15 µm or when extra-clean samples or sterile filtration is required


## Desalting and buffer exchange


Desalting columns are suitable for many different sample volumes and will rapidly remove low-molecular-weight contaminants in a single step at the same time as transferring the sample into the correct buffer conditions. If desalting is the first chromatographic step, clarification will be needed. Centrifugation and/or filtration of the sample before desalting is recommended. Detailed procedures for buffer exchange and desalting are given in Chapter 11.


Dialysis and centrifugal ultrafiltration/concentration are also options for desalting and/or buffer exchange, but the speed of using a desalting column makes it an especially attractive option.

 The need for a change in conditions can sometimes be met simply by dilution (to reduce ionic strength), addition [to increase ammonium sulfate concentration for hydrophobic interaction chromatography (HIC)], or titration to adjust pH.

At laboratory scale, when samples are reasonably clean after filtration or centrifugation, the buffer exchange and desalting step can be omitted. For AC or ion exchange chromatography (IEX), it may be sufficient to adjust the pH of the sample and, if necessary, adjust the ionic strength of the sample. Refer to Chapter 11 for information on columns for buffer exchange.

 Rapidly process small or large sample volumes. Use before purification, between purification steps, and as the final step if needed (remember that each extra step can reduce yield and that desalting also dilutes the sample unless centrifugation is used).

 To remove salt from proteins with molecular weight > 700, use Sephadex™ G-10; for proteins with a molecular weight > 5000, use Sephadex G-25.

 Use 100 mM ammonium acetate or 100 mM ammonium hydrogen carbonate if volatile buffers are required.

## Detection and quantitation

Detection and quantitation of the target protein are needed when optimizing purification protocols. For over-expressed proteins, the high concentration in itself can be used for detection of the target protein fraction in a chromatogram, but in such a case verification of the identity of the protein in the final preparation is needed. Specific detection of tagged proteins can often be accomplished by analyzing the presence of the tag by activity or immunoassay, or simply by the spectral properties of the tag. This may be especially important when multiple constructs with the same tag are prepared in high-throughput platforms. Specific detection of the target protein can be obtained by functional assays, immunodetection, and mass spectrometry. SDS-polyacrylamide gel electrophoresis (SDS-PAGE) is the key method for checking purity of proteins. The target protein band can often be identified using the apparent relative molecular weight ( $M_r$ ), obtained by including standard molecular weight markers in the analysis. Subsequent verification of protein identity should always be obtained. Optimizing purification protocols may require functional assays to assess the intactness of the target protein. Detection methods specific for histidine- and GST-tagged proteins are discussed in Chapters 3 and 5, respectively. In general:

- The relative yield of tagged protein can often be determined by measuring the absorbance at 280 nm because the purity after a single purification step is high, that is, most of the eluted material may be considered to be the target protein. The extinction coefficient of the target protein will be needed. A good estimation may be obtained by theoretical calculation from the amino acid composition of the protein
- The yield of protein may also be determined by standard chromogenic methods (e.g., Lowry, BCA™ protein assay, Bradford, etc.)
- Immunoassays (Western blot, ELISA, immunoprecipitation, etc.) can be used for quantitation if a suitable standard curve can be produced. In this case, it is not necessary to purify the tagged protein so long as a purified standard is available. Therefore, these techniques may be used for quantitation during protocol development. The immunoassay technique is also particularly suitable for screening large numbers of samples when a simple yes/no answer is required (e.g., when testing fractions from a chromatographic run)



## Assessing protein expression

### Yield of expressed protein

Suboptimal expression of the target protein can be addressed by various methods, based on the cause of the problem. If no target protein is detected in the extract, this may mean that the insert has been cloned in an incorrect reading frame. It is essential that the protein-coding DNA sequences are cloned in the proper translational reading frame in the vector. The best way to verify that the insert is in-frame is to sequence the cloning junctions.

If yield of the target protein is low, it may be because the culture conditions have not been optimized for its expression. Investigate the effect of cell strain, medium composition, incubation temperature, and induction conditions (if applicable). Exact conditions will vary for each tagged protein expressed.

With *E. coli* systems, analyze a small aliquot of an overnight culture by, for example, SDS-PAGE or Western blot if the target protein concentration is low, and if available, use an activity assay. For nonspecific detection systems such as SDS-PAGE, enrichment of the target protein with AC medium may be useful.

Generally, a highly expressed protein will be visible by Coomassie™ blue staining when 5 to 10  $\mu\text{L}$  of an induced culture whose  $A_{600}$  is  $\sim 1.0$  is loaded on the gel. Nontransformed host *E. coli* cells and cells transformed with the parental vector should be run in parallel as negative and positive controls, respectively.

### Cellular location of expressed protein

The presence of the tagged protein in a total cell extract and its absence from a clarified lysate may indicate the presence of inclusion bodies. Check for inclusion bodies using light microscopy. They are often visible as dense spots in the cells. Refer to Chapter 10 for information on handling inclusion bodies. Sometimes the target protein may be adsorbed to cell debris. Adjustment of pH and ionic strength for cell disruption may release the protein from the debris.

It is also worthwhile to check for expression by immunoblotting. Run an SDS-polyacrylamide gel of induced cells and transfer the proteins to a nitrocellulose (NC) or PVDF membrane such as Amersham™ Protran™ or Amersham Hybond™ P, respectively. Detect tagged protein using either a specific antibody toward the tag or an antibody directed toward the specific target protein. Some tagged proteins may be masked on SDS-PAGE by a bacterial protein of approximately the same molecular weight. Immunoblotting can be used to identify tagged proteins in these cases.

If the target protein is present in the post-lysate pellet, consider methods to enrich it. Alternatively, choose to secrete the product or add a stabilizing tag.

If the target protein is adsorbed to cell debris, test extraction at varying ionic strengths and pH to dissociate it.

## Modifications to protein expression

Occasionally, a high basal level of expression is observed, and this may pose problems of its own (e.g., this is a major concern if the expressed protein is toxic). The cause may be a leaky promoter. Different vector systems rely on different constitutive and induced promoters, thus the most straightforward means of addressing this problem is to try another expression system. It is also possible that the vector is simply not compatible with the expression host; trying another vector or host may alleviate this problem.

Various modifications to recombinant proteins can arise during growth, and these too may affect expression levels. These modifications include aggregation; misfolding and random disulfide bridges; deamidation of asparagine and glutamine; oxidation of methionine; proteolytic cleavage; and other modifications such as glycosylation, phosphorylation, and acylation. Discussion of these modifications is beyond the scope of this handbook, but a simple first approach to reducing or eliminating problems relating to them is to investigate the effect of cell strain, medium composition, incubation temperature, and induction conditions. Exact conditions will vary for each tagged protein expressed.

Analytical tools useful for determining if a recombinant protein is correctly expressed are summarized in Table 1.7.

**Table 1.7.** Analytical tools for assessing characteristics of expressed protein

Analytical tool	Characteristic being assessed
SDS-PAGE and immunoblotting	Size Proteolytic cleavage
Native PAGE	Aggregation
Isoelectric focusing (IEF)	Heterogeneity
Tests for biological activity	Stability at different pH, ionic strengths, protein concentrations, detergent concentrations
N-terminal sequencing	Heterogeneous N-terminus
Mass spectrometry	Size, sequence heterogeneities, post-translational heterogeneities, chemical modifications of amino acid residues
C-terminal sequencing (difficult method performed in specialized labs)	Truncated forms

**02**

# **Manual and automated purification**



Recombinant proteins are needed for research and industrial purposes in different qualities (e.g., with native structure or denatured) and quantities (from microgram to gram scales). One needs to choose a purification method that will yield protein of a quality and quantity that fits the intended use. The number of samples that must be purified is also an important consideration. It may be possible to save valuable time and protein samples by investing in a chromatography system.

## Tagged recombinant proteins for simple purification

When a recombinant protein is fused to a peptide or protein tag, such as histidine, glutathione S-transferase (GST), maltose binding protein (MBP), or *Strep*-tag II, the properties of the tag can be exploited for purification purposes. AC methods have been developed for each of the commonly used tags, and there is a good chance of a successful purification of a tagged protein in a single step.

## Manual purification techniques

A number of manual purification formats are available for purification of tagged proteins (Fig 2.1 to 2.5). All formats are based on established chromatography media and include gravity-flow columns (GraviTrap), spin columns (SpinTrap), magnetic beads (Mag Sepharose), and 96-well plates (MultiTrap). In addition, prepacked HiTrap columns can be used with a syringe for manual purification. The different formats are suitable for single samples as well as multiple samples in parallel. Magnetic beads and 96-well plates can also be used in combination with a robotic device, for example, during screening and process optimization.

The products for manual purification of histidine-, GST-, MBP- and *Strep*-tag II-tagged proteins are presented in Chapter 3, 5, 6 and 7, respectively.



**Fig 2.1.** Mag Sepharose paramagnetic beads.

**Mag Sepharose** paramagnetic beads are designed for simple enrichment of proteins and small-scale purification or screening. The slurry volume of Mag Sepharose beads can be varied in a linear manner to match capacity needs, and large sample volumes of low-expressed target protein can be enriched and concentrated. Sample volume from a few microliters to about 50 mL can be used with Mag Sepharose in combination with the magnetic racks MagRack 6 and MagRack Maxi. Mag Sepharose products for histidine-tagged proteins: His Mag Sepharose Ni, His Mag Sepharose excel.



**Fig 2.2.** SpinTrap microspin columns.

**SpinTrap** prepacked microspin columns enable fast small-scale purification of target protein using a benchtop microcentrifuge. SpinTrap columns are prepacked with chromatography medium. Multiple samples can be processed simultaneously. SpinTrap products: His SpinTrap, GST SpinTrap.



**Fig 2.3.** MultiTrap plates.

**MultiTrap** plates are prepacked 96-well filter plates for high-throughput processing of multiple samples; typically used for expression screening of proteins or optimization of conditions for capture and elution of target molecules. Each well is prepacked with a fixed volume of AC medium. MultiTrap can be used manually or in automated systems, together with vacuum or centrifugation. MultiTrap products: His MultiTrap, His MultiTrap TALON, GST MultiTrap.



**Fig 2.4.** GraviTrap columns.

**GraviTrap** columns are prepacked gravity-flow columns for purification of proteins without the need for a chromatography system. GraviTrap products: His GraviTrap, His GraviTrap TALON, GST GraviTrap.



**Fig 2.5.** HiTrap columns.

**HiTrap** columns are prepacked 1 or 5 mL columns that can be used either with a syringe for manual use, a laboratory pump, or a chromatography system. A broad range of columns is available for purification of tagged proteins. HiTrap products: HisTrap HP, HisTrap FF, HisTrap FF crude, HisTrap excel, HisTrap TALON crude, GSTrap™ HP, GSTrap FF, GSTrap 4B, MBPTrap™ HP, StrepTrap™ HP.



## Selection of purification equipment

Simple AC purification with step elution can be performed using a syringe or peristaltic pump with prepacked HiTrap columns. A chromatography system is required when reproducible results are important and when manual purification becomes too time-consuming and inefficient. This can be the case when large sample volumes are handled, or when there are many different samples to be purified. The progress of the purification can be monitored automatically and high-resolution separations with accurately controlled linear-gradient elution can be performed.

Table 2.1 lists the standard ÄKTA™ system configurations, see also *ÄKTA Laboratory-scale Systems: Instrument Management Handbook*, 29010831.

**Table 2.1.** Ways of working with standard ÄKTA chromatography systems



Way of working		ÄKTA start	ÄKTAprime plus	ÄKTAxpress	ÄKTA pure		ÄKTA avant	
Simple, one-step desalting, buffer exchange	Research ↓	●	●	●	●	Process development ↓	●	
Automated and reproducible protein purification using all common techniques including support for gradient elution		●	●	●	●		●	
Software compatible with regulatory requirements, e.g., good laboratory practice (GLP)				●	●		●	
Method development and optimization using design of experiments (DoE)				○	●		●	
Automatic buffer preparation including pH scouting					●		○	●
Automatic medium or column scouting				○	●		○	●
Automatic, multistep purification				○	●		○	○
Scale-up, process development			○	○	○	●		
Flow rate (mL/min)		0.5 to 5.0	0.1 to 50.0	0.1 to 65.0	0.001 to 25.0 (ÄKTA pure 25)/ 0.01 to 150 (ÄKTA pure 150)		0.001 to 25/0.01 to 150	
Max. operating pressure (MPa)		0.5	1	3	20/5		20/5	
Software <sup>1</sup> for system control and data handling		UNICORN™ start	PrimeView™ <sup>2</sup>	UNICORN 5	UNICORN 6 or later		UNICORN 6 or later	

<sup>1</sup> A specific software version might be needed for the chosen system. See the web page for each respective system at [www.cytiva.com/AKTA](http://www.cytiva.com/AKTA).

<sup>2</sup> With PrimeView, you can monitor results and evaluate data but not create methods nor control the system.

● = included

○ = optional



**03**

# **Purification of histidine-tagged recombinant proteins**

Histidine-tagged proteins have a high selective affinity for Ni<sup>2+</sup> and several other metal ions that can be immobilized on chromatographic media using chelating ligands. Consequently, a protein containing a histidine tag will be selectively bound to metal-ion-charged media such as Ni Sepharose High Performance (HP) and Ni Sepharose 6 Fast Flow (FF) while other cellular proteins will not bind or will bind weakly. This chromatographic technique is often termed immobilized metal ion affinity chromatography (IMAC). In general, the histidine-tagged protein is the strongest binder among all the proteins in a crude sample extract (for example, a bacterial lysate). Eukaryotic extracts often have slightly more endogenous proteins that can bind. Moreover, histidine tags are small and generally less disruptive than other tags to the properties of the proteins on which they are attached. Because of this, tag removal may not always be a priority.

Histidine-tagged protein expressed in *E. coli* can accumulate in two main forms, as biologically functional soluble proteins or as inclusion bodies. Inclusion bodies are insoluble aggregates of denatured or partly denatured protein that lack biological activity but often allow high expression levels of the recombinant protein. To restore biological function of proteins expressed as inclusion bodies, solubilization, refolding, and purification are necessary. This topic is discussed in more detail in Chapter 10. Purification of histidine-tagged proteins secreted into eukaryotic cell culture, such as insect cells or Chinese hamster ovary (CHO) cells, often leads to stripping of the immobilized metal ions because of chelating agents present in the cell culture medium. Ni Sepharose excel has strongly bound nickel ions and is especially designed for purifying histidine-tagged proteins from eukaryotic cell cultures or from other samples that cause nickel stripping.

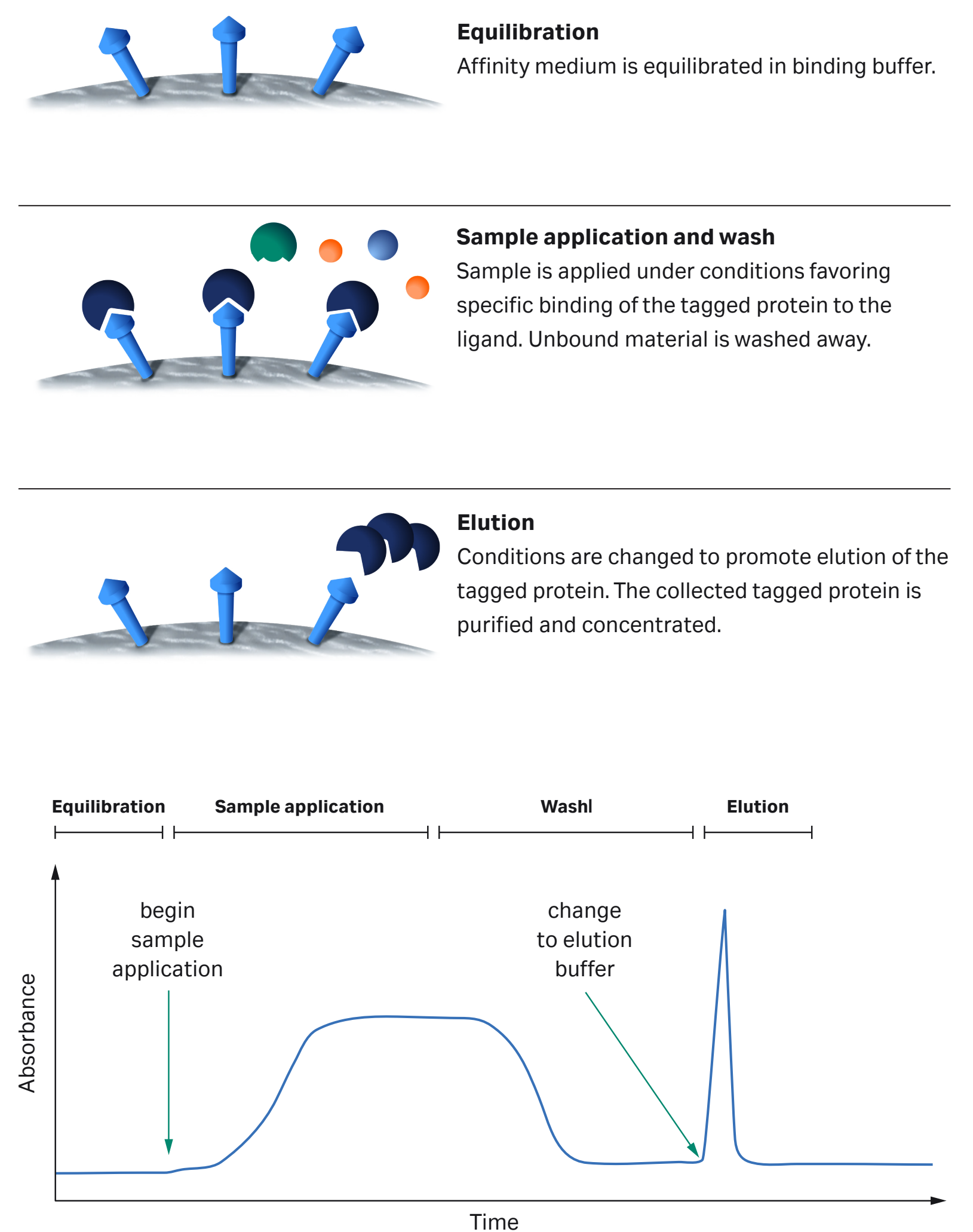
## Expression

General considerations for the expression of tagged proteins are discussed in Chapter 1, as are the factors that should be considered when selecting the vector and host.

## Purification overview

Figure 3.1 gives an overview of a typical purification workflow for histidine-tagged proteins under native conditions. On-column refolding and purification of histidine-tagged proteins are also discussed in Chapter 10.

For simple, one-step purification of histidine-tagged proteins, a range of products is available designed to meet specific purification needs. These products can be used for the purification of proteins containing polyhistidine tags of different lengths (four to 10 histidine residues). A tag that is six residues long, (histidine)<sub>6</sub>, is most common. Under the standard binding and elution conditions described in this handbook, a longer (histidine)<sub>10</sub> will bind more strongly as compared with (histidine)<sub>6</sub>. An even shorter tag, for example (histidine)<sub>4</sub>, is generally not recommended due to interaction that is too weak. This difference in binding strength can be used to advantage during purification. For example, because a longer tag binds more strongly, a higher concentration of imidazole can be included in the sample during loading (to prevent unwanted host cell proteins from binding) as well as be used during the washing step before elution. This can facilitate the removal of contaminants that may otherwise be copurified with a shorter tagged protein. For information on optimizing protein purification of histidine-tagged proteins, refer to Chapter 4.



**Fig 3.1.** General purification workflow for histidine-tagged proteins under native conditions. All metal-ion-charged chromatography media follow the same workflow although the imidazole concentrations in the binding and elution buffer may differ. The workflow is also valid for purification under denaturing conditions (including 8 M urea or 6 M Gua-HCl).



## General considerations

### Types of chromatography media and formats

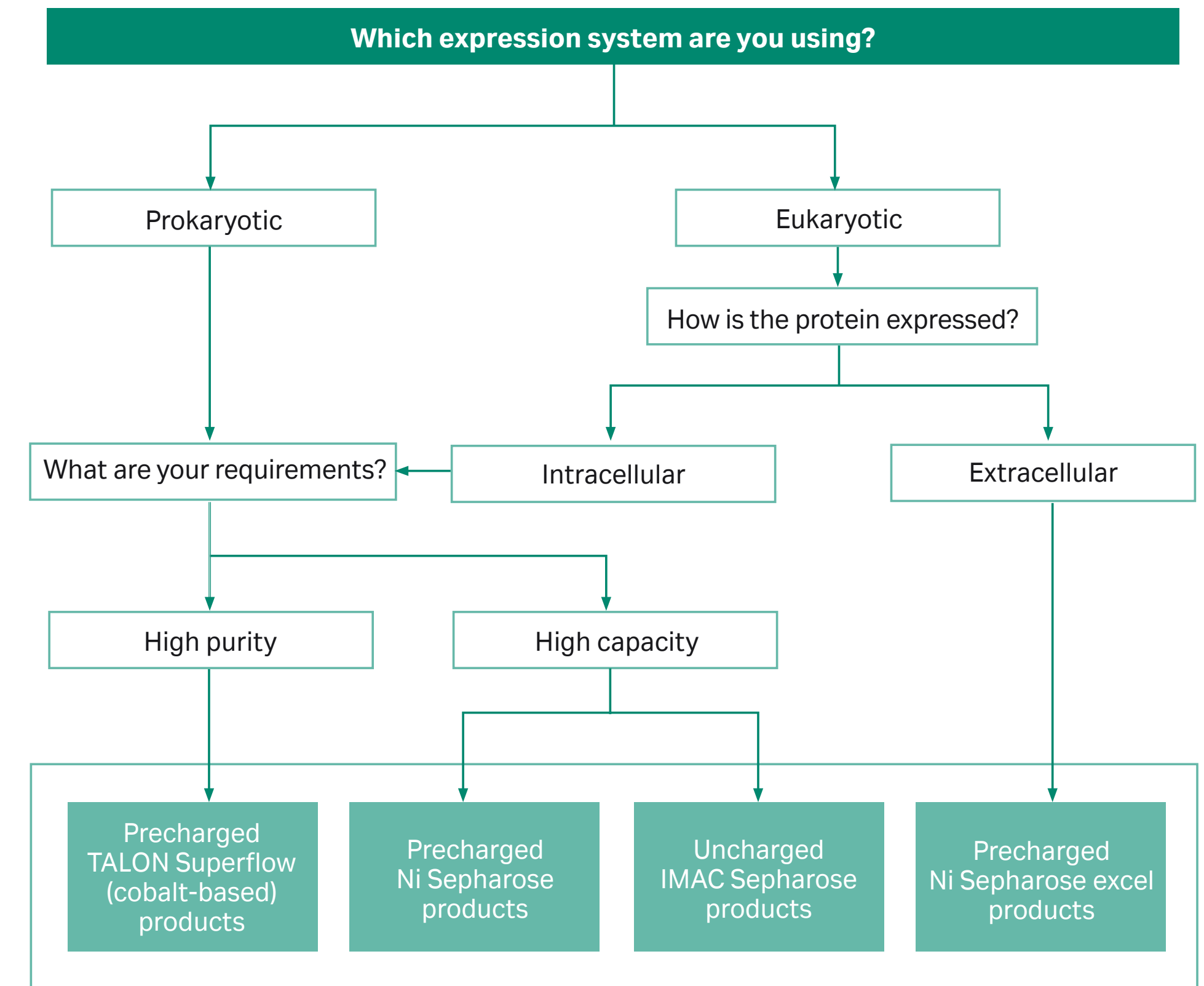
Chromatography media for purifying histidine-tagged proteins are available precharged with Ni<sup>2+</sup> or Co<sup>2+</sup> ions as well as uncharged. Uncharged media can be charged with different metal ions to adjust selectivity. Charged media from Cytiva include Ni Sepharose High Performance, Ni Sepharose 6 Fast Flow, Ni Sepharose excel, and TALON Superflow™ (Co<sup>2+</sup> ions) in lab packs (bulk media) and prepacked formats. In addition, His Mag Sepharose Ni and His Mag Sepharose excel are magnetic-bead-based IMAC media charged with Ni<sup>2+</sup> ions. Uncharged media include IMAC Sepharose High Performance and IMAC Sepharose 6 Fast Flow in lab packs and prepacked formats.

Ni Sepharose High Performance, Ni Sepharose 6 Fast Flow, Ni Sepharose excel, and TALON Superflow consist of highly cross-linked agarose beads with an immobilized chelating group. The first three media are precharged with Ni<sup>2+</sup> ions as the product names indicate, and TALON Superflow is precharged with Co<sup>2+</sup>. The chromatography media are compatible with all commonly used aqueous buffers, reducing agents, and a range of additives commonly used in protein purification. Refer to Appendix 1 for a list of characteristics of the media and compatibility guides.

Different sizes and types of prepacked columns and 96-well filter plates together with easily packed bulk media (lab packs) provide fast, convenient protein purification. Batch preparations are occasionally used if it appears that the tag is not fully accessible or when the protein in the lysate is at very low concentrations (both could appear to give a low yield from the first purification step). A more convenient alternative to improve yield may be to decrease the flow rate or pass the sample through the column several times.

For high capacity, we recommend always trying the precharged Ni Sepharose High Performance or Ni Sepharose 6 Fast Flow media first. The same chromatography media without Ni<sup>2+</sup> ions are also available. If you determine that increased selectivity would be advantageous, try TALON Superflow, precharged with Co<sup>2+</sup>, or try applying other metal ions to one of the uncharged media. For samples that cause extensive nickel stripping, Ni Sepharose excel is recommended. Ni Sepharose excel is designed for capture and purification of histidine-tagged proteins secreted into eukaryotic cell culture supernatants, such as insect cells or CHO cells. Ni Sepharose excel is also suitable for purification of histidine-tagged proteins from other samples that cause nickel stripping. See Figure 3.2 for advice on selecting the product category appropriate for your requirements.


Monitor purification steps using one or more of the detection methods referred to later in this chapter. The choice of purification equipment should also be made according to the needs of the purification (see Chapter 2).



**Fig 3.2.** Select the product category appropriate for your requirements.

## Metal ion


In general, Ni<sup>2+</sup> is the preferred metal for purification of recombinant histidine-tagged proteins. Note, however, that in some cases it may be wise to test other metal ions, for example Co<sup>2+</sup> and Zn<sup>2+</sup>, as the strength of binding depends on the nature of the histidine-tagged protein as well as the metal ion. This topic is also discussed in Chapter 4.


 Leakage of Ni<sup>2+</sup> from Ni Sepharose Fast Flow and Ni Sepharose High Performance is low under all normal conditions (see Data file 11000886), which is also the case for Ni Sepharose excel, TALON Superflow, IMAC Sepharose High Performance, and IMAC Sepharose 6 Fast Flow. For very critical applications, leakage during purification can be reduced even further by performing a blank run before loading the sample (see purification procedures).

 Working with nickel- and cobalt-containing products may produce an allergic reaction.


## Buffers

 Water and chemicals used for buffer preparation should be of high purity. Filter buffers through a 0.22 µm or 0.45 µm filter before use.


 We recommend use of the His Buffer Kit (available separately) to eliminate time-consuming buffer preparation, thus promoting fast, reproducible, and convenient purification work. The kit contains phosphate buffer concentrates and highly pure 2 M imidazole stock solution optimized for rapid purification of histidine-tagged proteins.

 We recommend binding at neutral to slightly alkaline pH (pH 7 to 8) in the presence of 0.3 to 1.0 M NaCl. Including salt in the buffers and samples eliminates ion-exchange effects but can also have a marginal effect on the yield of proteins.

Sodium phosphate buffers are often used. Tris-HCl can generally be used but should be avoided in cases where the metal-protein affinity is weak, because it may reduce binding strength. Imidazole is usually used for elution of histidine-tagged proteins due to its efficiency at replacing the histidine tag by also interacting with the metal ion (see below).

 Avoid chelating agents such as EDTA or citrate in buffers. Ni Sepharose excel is more resistant to EDTA, and chemical stability for 24 h in 10 mM EDTA has been shown.

Membrane proteins must be purified in the presence of a detergent in the sample and buffers. Note that the NaCl concentration may need to be optimized to avoid precipitation. Proteins expressed as inclusion bodies can be solubilized in denaturants such as 8 M urea or 6 M Gua-HCl. The solubilized and denatured protein can then be purified in the presence of the denaturant. If on-column refolding is to be performed, an eluent with low concentration (or zero concentration) should be prepared. Refer to Chapter 10 for a discussion of working with inclusion bodies.

 Samples containing urea can be analyzed directly by SDS-PAGE whereas samples containing Gua-HCl must be buffer-exchanged before SDS-PAGE, due to the high ionic strength of Gua-HCl solutions.

## Imidazole


Imidazole competes with proteins for binding to metal-ion-charged chromatography media. Equilibration buffer (binding and wash buffer) and sample are usually complemented with a low concentration of imidazole to reduce nonspecific binding of host cell proteins. At somewhat higher concentrations, imidazole may also decrease the binding of histidine-tagged proteins. The imidazole concentration in each step must therefore be optimized to ensure the best balance of high purity (low binding of host cell proteins) and high yield (strong binding of histidine-tagged target protein). The concentration of imidazole in the binding buffer and sample that will give optimal purification results is protein dependent. A concentration of 500 mM imidazole in the elution buffer ensures complete elution of the histidine-tagged protein. See Chapter 4 for a discussion on optimizing purification of histidine-tagged proteins by altering the imidazole concentration.

 Use high-purity imidazole as this will give very low or no background absorbance at 280 nm.


 If imidazole needs to be removed from the protein, use a desalting column (see Chapter 11).

### Alternative elution solutions

As alternatives to imidazole elution, histidine-tagged proteins can be eluted by other methods or combinations of methods; for example, lowering of pH within the range of 2.5 to 7.5 can be used. Below pH 4, metal ions will be stripped off the chromatography medium.

 It is not always possible to elute with lower pH when using a metal ion other than  $\text{Ni}^{2+}$ . This is protein and metal ion dependent.

EGTA and EDTA, which are strong chelating compounds, can also be used for elution, but they will strip the metal ions from the medium and thereby cause protein elution. The co-eluted metal ions will remain chelated in the protein solution, but are easily removed with a desalting column (see Chapter 11).

 After elution with chelating compounds, the column needs to be recharged with metal ions before the next purification.

 Elution with EGTA and EDTA can not be performed using Ni Sepharose excel.


## Cell lysis

For optimal conditions for growth, induction, and cell lysis of recombinant histidine-tagged proteins, please refer to established procedures. The following is a general procedure for cell lysis and sample preparation from bacterial cultures. Other established procedures may also work.

This procedure works well with the majority of the purification protocols included in this chapter. However, some modifications of the procedures are noted where relevant.

1. Harvest cells from the culture by centrifugation at 7000 to 8000  $\times$  g for 10 min or at 1000 to 1500  $\times$  g for 30 min at 4°C.
2. Discard the supernatant. Place the bacterial pellet on ice.
3. Dilute the cell paste (bacterial pellet) by adding 5 to 10 mL of binding buffer for each gram of cell paste.
4. Enzymatic lysis: Add 0.2 mg/mL lysozyme, 20  $\mu\text{g}/\text{mL}$  DNase, 1 mM  $\text{MgCl}_2$ , 1 mM Pefabloc™ SC or phenylmethylsulfonyl fluoride (PMSF) (final concentrations). Stir for 30 min at room temperature or 4°C, depending on the sensitivity of the target protein.
5. Mechanical lysis:  
Sonication on ice, approximately 10 min.  
*or*  
Homogenization with a French press or other homogenizer.  
*or*  
Freeze/thaw, repeated at least five times.




 Mechanical lysis time may have to be extended to obtain an optimized lysate for sample loading to avoid problems with back pressure. This is important when direct loading of unclarified, crude sample is performed (using HisTrap FF crude, HiTrap TALON crude, or HiTrap excel columns). Different proteins have different sensitivity to cell lysis, and caution should be exercised to avoid heating and frothing of the sample.


6. Measure and adjust pH if needed.


 Do not use strong bases or acids for pH adjustment, as this may increase the risk of precipitation.

If the sonicated or homogenized unclarified cell lysate is frozen before use, precipitation and aggregation may increase. New mechanical lysis of the lysate can then prevent increased back-pressure problems when loading on the column.

## Sample preparation

 If the sample is prepared in a buffer other than the binding buffer, adjust the sample to the composition and pH of the binding buffer by adding buffer and additives from concentrated stock solutions; by diluting the sample with binding buffer; or by buffer exchange.

 Pass the sample through a 0.22  $\mu\text{m}$  or a 0.45  $\mu\text{m}$  filter and/or centrifuge it immediately before applying it to the column. If the sample is too viscous, dilute it with binding buffer to prevent it from clogging the column; increase lysis treatment (sonication, homogenization); or add DNase/RNase to reduce the size of nucleic acid fragments. *Note:* Filtration is **NOT** necessary when using HisTrap FF crude, His GraviTrap, His MultiTrap HP, His MultiTrap FF, HisTrap excel, or HiTrap TALON crude.

 If the recombinant histidine-tagged protein is expressed as inclusion bodies, the inclusion bodies are solubilized using 6 M Gua-HCl or 8 M urea, and the chosen denaturant must be present in all buffers during chromatography. Advice for working with inclusion bodies can be found in Chapter 10 and in the troubleshooting section later in this chapter.

## Purification using precharged chromatography media

Table 3.1 summarizes the products containing precharged media. Similar information for the uncharged media follows later in this chapter.

**Table 3.1.** Purification options for histidine-tagged proteins using precharged media

Product	Format or column size	Approx. protein binding capacity <sup>1</sup>	Description <sup>2</sup>	High-throughput screening	Minipreps	Batch/ gravity flow	Syringe compatible	Scale-up	ÄKTA system compatible	Process development	Magnetic separation
Ni Sepharose High Performance	25 mL	40 mg/mL	For high resolution and elution of a more concentrated sample (high-performance purification)	•					•		
	100 mL										
	96-well filter plates	1 mg/well	For high-throughput screening. Can be used with robotics or manually by centrifugation or vacuum.	•	•						
	100 µL	0.75 mg/column	For simple minipreps of histidine-tagged proteins and rapid expression screening. Kit contains 50 columns and His Buffer Kit.	•	•						
HisTrap HP	1 mL	40 mg/column	For use mainly with a peristaltic pump or chromatography system.						•		
	5 mL	200 mg/column	For high resolution and elution of a more concentrated sample (high-performance purification).						•		
Ni Sepharose 6 Fast Flow	5 mL	40 mg/mL	Excellent for scale-up due to high capacity and high flow properties.								
	25 mL										
	100 mL										
	500 mL					•	•	•		•	

<sup>1</sup> Protein dependent.

<sup>2</sup> Note: All products include easy to follow instructions.

■ Contains Ni Sepharose High Performance

■ Contains Ni Sepharose 6 Fast Flow

■ Contains Ni Sepharose excel

■ Contains TALON Superflow

**Table 3.1.** Purification options for histidine-tagged proteins using precharged media (continued)

Product	Format or column size	Approx. protein binding capacity <sup>1</sup>	Description <sup>2</sup>	High-throughput screening	Minipreps	Batch/ gravity flow	Syringe compatible	Scale-up	ÄKTA system compatible	Process development	Magnetic separation
His MultiTrap FF	96-well filter plates	0.8 mg/well	For high-throughput screening. Can be used with robotics or manually by centrifugation or vacuum.	•	•						
HisTrap FF	1 mL	40 mg/column	For use with syringe, peristaltic pump, or chromatography system.				•		•		
	5 mL	200 mg/column	Provides excellent flow properties. Scale-up purification.				•		•		
HisTrap FF crude	1 mL	40 mg/column	For use with syringe, peristaltic pump, or chromatography system.				•		•		
	5 mL	200 mg/column	For direct load of unclarified sample.				•		•		
HisTrap FF crude Kit	1 mL	40 mg/column	For use with unclarified cell lysates. Kit includes three columns and His Buffer Kit.				•				
His GraviTrap and His GraviTrap Kit	1 mL	40 mg/column	For use with gravity flow, allows direct purification of either clarified or unclarified cell lysates. Kit includes 20 columns and His Buffer Kit.			•					
HiScreen™ Ni FF	4.7 mL	188 mg/column	For use with a chromatography system. For screening of selectivity and binding/elution conditions for scaling up, as well as for small-scale purifications.					•	•	•	
HisPrep™ FF 16/10	20 mL	800 mg/column	For use with a chromatography system. Preparative purification.					•	•		
His Mag Sepharose Ni	5% medium slurry: 1 mL 5 mL 10 mL	50 mg/mL	Magnetic beads designed for efficient, small-scale purification/ screening.	•	•						•

<sup>1</sup> Protein dependent.

<sup>2</sup> Note: All products include easy to follow instructions.

■ Contains Ni Sepharose High Performance

■ Contains Ni Sepharose 6 Fast Flow

■ Contains Ni Sepharose excel

■ Contains TALON Superflow

**Table 3.1.** Purification options for histidine-tagged proteins using precharged media (continued)

Product	Format or column size	Approx. protein binding capacity <sup>1</sup>	Description <sup>2</sup>	High-throughput screening	Minipreps	Batch/gravity flow	Syringe compatible	Scale-up	ÄKTA system compatible	Process development	Magnetic separation
Ni Sepharose excel	25 mL	10 mg/mL	For capture and purification of histidine-tagged proteins secreted into eukaryotic cell culture supernatants.	•		•		•	•		
	100 mL										
	500 mL										
HisTrap excel	1 mL	10 mg/column	For direct loading of unclarified sample. For use with a syringe, peristaltic pump, or chromatography system. For capture and purification of histidine-tagged proteins secreted into eukaryotic cell culture supernatants.				•		•		
	5 mL	50 mg/column					•		•		
His Mag Sepharose excel	10% medium slurry: 1 mL	10 mg/column	Magnetic beads for simple small-scale capture and purification of histidine-tagged proteins secreted into eukaryotic cell culture supernatants.	•	•						•
TALON Superflow	10 mL 50 mL	20 mg/mL	A cobalt-charged IMAC medium for enhanced selectivity for histidine-tagged proteins compared with nickel-charged media.	•		•		•	•		
His MultiTrap TALON	96-well filter plates	up to 1 mg/well	For high-throughput screening. Can be used with robotics or manually by centrifugation or vacuum. The medium is cobalt charged.	•	•						
His SpinTrap TALON	100 µL	up to 1 mg/column	For simple minipreps of histidine-tagged proteins. The medium is cobalt charged.	•	•						
His GraviTrap TALON	1 mL	up to 15 mg/column	For use with gravity flow. Large sample volumes of clarified or unclarified supernatants can be applied. The medium is cobalt charged.			•					

<sup>1</sup> Protein dependent.

<sup>2</sup> Note: All products include easy to follow instructions.

■ Contains Ni Sepharose High Performance

■ Contains Ni Sepharose 6 Fast Flow

■ Contains Ni Sepharose excel

■ Contains TALON Superflow



**Table 3.1.** Purification options for histidine-tagged proteins using precharged media (continued)

Product	Format or column size	Approx. protein binding capacity <sup>1</sup>	Description <sup>2</sup>	High-throughput screening	Minipreps	Batch/ gravity flow	Syringe compatible	Scale-up	ÄKTA system compatible	Process development	Magnetic separation
HiTrap TALON crude	1 mL	20 mg/column	For direct loading of unclarified sample. For use with a syringe, peristaltic pump, or chromatography system. The medium is cobalt charged.				.		.		
	5 mL	100 mg/column					.		.		
<b>Companion product</b>											
His Buffer Kit	1 kit	N/A	Premade buffers for manual purification of histidine-tagged proteins.		.	.	.				

<sup>1</sup> Protein dependent.

<sup>2</sup> Note: All products include easy to follow instructions.

■ Contains Ni Sepharose High Performance

■ Contains Ni Sepharose 6 Fast Flow

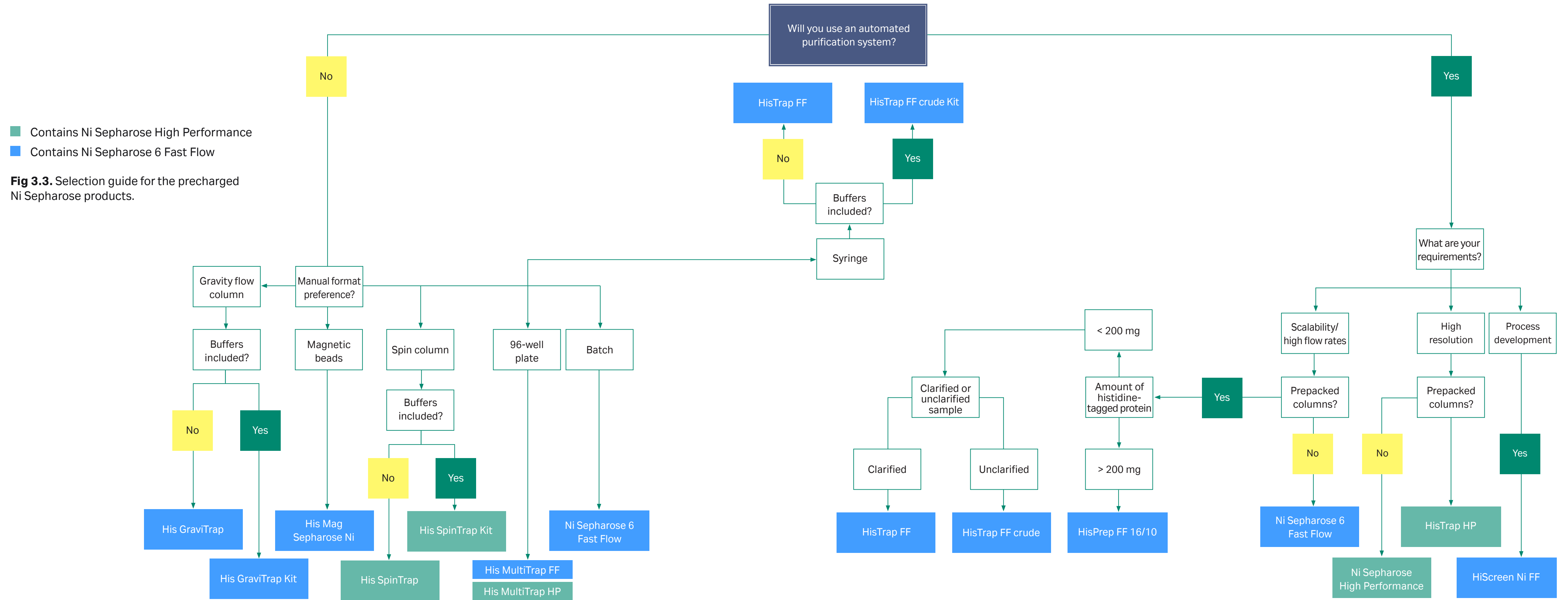
■ Contains Ni Sepharose excel

■ Contains TALON Superflow

# Purification using Ni Sepharose products

Figure 3.3 provides a selection guide for the precharged Ni Sepharose products containing Ni Sepharose High Performance and Ni Sepharose 6 Fast Flow. In general, Ni Sepharose High Performance is recommended when high resolution and high capacity are important, whereas Ni Sepharose 6 Fast Flow is recommended when scale-up is required.

For histidine-tagged proteins secreted into eukaryotic cell culture, see *Purification using Ni Sepharose excel products*, later in this chapter.



## Purification using Ni Sepharose High Performance

Ni Sepharose High Performance consists of highly cross-linked 6% agarose beads (34  $\mu\text{m}$ ) to which a chelating group has been immobilized and subsequently charged with  $\text{Ni}^{2+}$  ions. The chromatography medium provides very high binding capacity for histidine-tagged proteins and shows negligible leakage of  $\text{Ni}^{2+}$  ions.

Ni Sepharose High Performance is compatible with all commonly used aqueous buffers, reducing agents, and denaturants such as 6 M Gua-HCl and 8 M urea, as well as a range of other additives, and allows thorough procedures for cleaning the medium (see Appendix 1). It is stable over a broad pH range. This high chemical and physical stability and broad compatibility allows maintenance of biological activity and increases the yield of the purified product.

The good flow properties and high resolution make Ni Sepharose High Performance the choice for high-performance purifications. See Appendix 1 for the main characteristics of Ni Sepharose High Performance.

Ni Sepharose High Performance is supplied preswollen in 20% ethanol, in pack sizes of 25 and 100 mL, as well as in the convenient prepacked formats described later in this chapter.

### Column packing

See instructions supplied with the product, or refer to Appendix 6 for general guidelines for column packing.

### Sample preparation

This sample preparation procedure is applicable for all formats containing Ni Sepharose High Performance. See *Cell lysis* earlier in this chapter for a general description.

- Adjust the sample to the composition and pH of the binding buffer by adding buffer, NaCl, imidazole, and additives from concentrated stock solutions; by diluting the sample with binding buffer; or by buffer exchange. To prevent the binding of host cell proteins with exposed histidines, it is essential to include imidazole at a low concentration in the sample and binding buffer (see Chapter 4).
- Pass the sample through a 0.22  $\mu\text{m}$  or a 0.45  $\mu\text{m}$  filter and/or centrifuge it immediately before sample application. Filtration is not necessary when using His MultiTrap HP. If the sample is too viscous, dilute it with binding buffer to prevent it from clogging; increase lysis treatment (sonication, homogenization); or add DNase/RNase to reduce the size of nucleic acid fragments.






**Fig 3.4.** Ni Sepharose High Performance precharged with  $\text{Ni}^{2+}$  for high-performance purification of histidine-tagged proteins.



## Buffer preparation


Binding buffer: 20 mM sodium phosphate, 0.5 M NaCl, 20 to 40 mM imidazole, pH 7.4 . (The optimal imidazole concentration is protein dependent; 20 to 40 mM is suitable for many proteins.)


Elution buffer: 20 mM sodium phosphate, 0.5 M NaCl, 500 mM imidazole, pH 7.4.


-  Water and chemicals used for buffer preparation should be of high purity. Filter buffers through a 0.45 µm filter before use. Use high-purity imidazole, as this will give a very low or no absorbance at 280 nm.
-  The optimal concentration of imidazole needed in the sample and buffer to obtain the best purity and yield differs from protein to protein. In the binding buffer, 20 to 40 mM imidazole is suitable for many proteins; 500 mM imidazole in the elution buffer ensures complete elution of the target protein.
-  As an alternative to elution with imidazole, lower the pH to approximately pH 4.5. (Metal ions will be stripped off the medium below pH 4.0.)


## Purification

1. If the column contains 20% ethanol, wash it with 5 column volumes of distilled water. Use a flow velocity of 50 to 100 cm/h. Refer to Appendix 8 for flow rate calculations.
2. Equilibrate the column with 5 to 10 column volumes of binding buffer at a flow velocity of 150 cm/h.
3. Apply the pretreated sample.
4. Wash with binding buffer until the absorbance reaches the baseline.
5. Elute with elution buffer using a step or linear gradient. For step elution, 5 column volumes of elution buffer are usually sufficient. For linear gradient elution, a shallow gradient, over 20 column volumes, may separate proteins with similar binding strengths.
6. After elution, regenerate the column by washing it with 5 to 10 column volumes of binding buffer. The column is now ready for a new purification.

 The column does not need to be stripped and recharged between each purification if the same protein is going to be purified. Reuse of any purification column depends on the nature of the sample and should only be performed with identical proteins to prevent cross-contamination. For more information on this topic and on cleaning and storage, refer to Appendix 1.

 Use the elution buffer as blank when measuring absorbance manually. If imidazole needs to be removed from the protein, use a desalting column (see Chapter 11). Low-quality imidazole will give a significant background absorbance at 280 nm.

 Ni Sepharose High Performance is compatible with reducing agents. However, we recommend removal of any weakly bound Ni<sup>2+</sup> ions before applying buffer/sample that includes reducing agents. This can be accomplished by performing a blank run without reducing agents (see below). Do not leave or store Ni Sepharose High Performance with buffers that include reducing agents.

 Leakage of Ni<sup>2+</sup> from Ni Sepharose High Performance is low under all normal conditions. For very critical applications, leakage during purification can be even further diminished by performing a blank run (as described below) before loading sample.

### Blank run:

Use binding buffer and elution buffer **without** reducing agents.

1. Wash the column with 5 column volumes of distilled water (to remove the 20% ethanol).
2. Wash with 5 column volumes of elution buffer.
3. Equilibrate with 10 column volumes of binding buffer.

## Purification using Ni Sepharose 6 Fast Flow

Ni Sepharose 6 Fast Flow consists of 90 µm beads of highly cross-linked agarose, to which a chelating ligand has been immobilized and subsequently charged with Ni<sup>2+</sup> ions. The ligand density of Ni Sepharose 6 Fast Flow ensures high binding capacity, and the chromatography medium shows negligible leakage of Ni<sup>2+</sup> ions. The high flow rate property of the Sepharose 6 Fast Flow matrix makes it well-suited for scaling-up but also for gravity-flow purposes. In addition, the medium is compatible with a wide range of additives commonly used in the purification of histidine-tagged proteins. See Appendix 1 for the main characteristics of Ni Sepharose 6 Fast Flow.

Ni Sepharose 6 Fast Flow is supplied preswollen in 20% ethanol, in pack sizes of 5, 25, 100, and 500 mL<sup>1</sup>, as well as in convenient prepacked formats as described later in this chapter.

<sup>1</sup> Larger quantities are available. Contact your local representative for more information.

### Column packing

See instructions supplied with the product, or refer to Appendix 6 for general guidelines for column packing.

### Sample preparation

This sample preparation procedure is applicable for all formats containing Ni Sepharose 6 Fast Flow. See *Cell lysis* earlier in this chapter for a general description.

- Adjust the sample to the composition and pH of the binding buffer by adding buffer, NaCl, imidazole, and additives from concentrated stock solutions; by diluting the sample with binding buffer; or by buffer exchange. To prevent the binding of host cell proteins with exposed histidine, it is essential to include imidazole at a low concentration in the sample and binding buffer (see Chapter 4).
- Pass the sample through a 0.22 µm or a 0.45 µm filter and/or centrifuge it immediately before sample application. Filtration is not necessary when using HisTrap FF crude, His GraviTrap, or His MultiTrap FF. If the sample is too viscous, dilute it with binding buffer to prevent it from clogging; increase lysis treatment (sonication, homogenization); or add DNase/RNase to reduce the size of nucleic acid fragments.



**Fig 3.5.** Ni Sepharose 6 Fast Flow is designed for scaling up purification of histidine-tagged proteins.



## Buffer preparation

Binding buffer: 20 mM sodium phosphate, 0.5 M NaCl, 20 to 40 mM imidazole, pH 7.4. (The optimal imidazole concentration is protein dependent; 20 to 40 mM is suitable for many proteins.)

Elution buffer: 20 mM sodium phosphate, 0.5 M NaCl, 500 mM imidazole, pH 7.4.

- Water and chemicals used for buffer preparation should be of high purity. Filter buffers through a 0.45 µm filter before use. Use high-purity imidazole, as this will give a very low or no absorbance at 280 nm.
- The optimal concentration of imidazole needed in the sample and buffer to obtain the best purity and yield differs from protein to protein. In the binding buffer, 20 to 40 mM imidazole is suitable for many proteins; 500 mM imidazole in the elution buffer ensures complete elution of the target protein.
- As an alternative to elution with imidazole, lower the pH to approximately pH 4.5. (Metal ions will be stripped off the medium below pH 4.0.)

## Purification

- If the column contains 20% ethanol, wash it with 5 column volumes of distilled water. Use a flow velocity of 50 to 100 cm/h.
- Equilibrate the column with 5 to 10 column volumes of binding buffer at a flow velocity of 150 cm/h.
- Apply the pretreated sample.
- Wash with binding buffer until the absorbance reaches the baseline.
- Elute with elution buffer using a step or linear gradient. For step elution, 5 column volumes of elution buffer are usually sufficient. For linear gradient elution, a shallow gradient, over 20 column volumes, may separate proteins with similar binding strengths.
- After elution, regenerate the column by washing it with 5 to 10 column volumes of binding buffer. The column is now ready for a new purification.

The column does not need to be stripped and recharged between each purification if the same protein is going to be purified. Reuse of any purification column depends on the nature of the sample and should only be performed with identical tagged proteins to prevent cross-contamination. For more information on this topic and on cleaning and storage, refer to Appendix 1.

Use the elution buffer as blank when measuring absorbance manually. If imidazole needs to be removed from the protein, use a desalting column (see Chapter 11). Low-quality imidazole will give a significant background absorbance at 280 nm.

Ni Sepharose 6 Fast Flow is compatible with reducing agents. However, we recommend removal of any weakly bound Ni<sup>2+</sup> ions before applying buffer/sample that includes reducing agents. This can be accomplished by performing a blank run without reducing agents (see below). Do not store Ni Sepharose 6 Fast Flow with buffers that include reducing agents.

Leakage of Ni<sup>2+</sup> from Ni Sepharose 6 Fast Flow is low under all normal conditions. For very critical applications, leakage during purification can be even further diminished by performing a blank run (as described below) before loading sample.

### Blank run:

Use binding buffer and elution buffer **without** reducing agents.

- Wash the column with 5 column volumes of distilled water (to remove the 20% ethanol).
- Wash with 5 column volumes of elution buffer.
- Equilibrate with 10 column volumes of binding buffer.



## High-throughput screening using His MultiTrap HP and His MultiTrap FF 96-well filter plates

His MultiTrap HP and His MultiTrap FF are prepacked, disposable 96-well filter plates for reproducible, high-throughput screening of histidine-tagged recombinant protein expression. Typical applications are expression screening of different constructs, screening for solubility of proteins, and optimization of the conditions for small-scale parallel purification. The plates are prepacked with precharged Ni Sepharose High Performance and Ni Sepharose 6 Fast Flow, respectively.

Each well of the prepacked His MultiTrap HP and His MultiTrap FF contains 500  $\mu\text{L}$  of a 10% slurry of Ni Sepharose High Performance or Ni Sepharose 6 Fast Flow in storage solution (50  $\mu\text{L}$  of medium in 20% ethanol) and has a capacity for purifying up to 1.0 mg and 0.8 mg of histidine-tagged protein, respectively. The plates are made of polypropylene and polyethylene.

Characteristics of the chromatography media and of His MultiTrap HP and His MultiTrap FF are listed in Appendix 1. The  $\text{Ni}^{2+}$ -charged media are compatible with all commonly used aqueous buffers, reducing agents, denaturants, such as 6 M Gua-HCl and 8 M urea, and a range of other additives. Prepacked His MultiTrap HP and His MultiTrap FF plates provide well-to-well and plate-to-plate reproducibility in terms of yield and purity of eluted protein. Automated robotic systems can be used, as well as manual handling using centrifugation or vacuum pressure. The purification procedure can easily be scaled up because Ni Sepharose is available in both larger prepacked formats and as lab packs. This allows screening using His MultiTrap plates followed by scale-up on a HisTrap 1 mL or 5 mL column using best conditions, which shortens optimization time.

### Sample and buffer preparation

His MultiTrap HP: refer to *Purification using Ni Sepharose High Performance* earlier in this chapter, for a general procedure for sample and buffer preparation.

His MultiTrap FF: refer to *Purification using Ni Sepharose 6 Fast Flow* earlier in this chapter for a general procedure for sample and buffer preparation.

- ➡ After thorough cell disruption, it is possible to apply unclarified lysate directly to the wells without precentrifugation and/or filtration of the sample.
- ➡ Apply the unclarified lysate to the wells directly after preparation, as the lysate may precipitate unless used immediately or frozen and thawed before use. Samples with precipitation may be sonicated to reduce clogging of the wells. Note that aging of the sample may reduce yields of the target protein.
- ➡ Lysis with commercial kits could give large cell debris particles that may interfere with drainage of the wells during purification. This problem can be solved by centrifugation or filtration of the sample before adding it to the wells.




**Fig 3.6.** His MultiTrap HP and His MultiTrap FF are prepacked 96-well filter plates for high-throughput expression screening of histidine-tagged proteins.


## Centrifugation procedure for high-throughput screening

### Preparing the 96-well filter plate

1. Peel off the bottom seal from the 96-well filter plate. Be sure to hold the filter plate over a sink to accommodate any leakage of storage solution when removing the bottom seal.
2. Hold the filter plate upside down and gently shake it to dislodge any medium adhering to the top seal. Return the filter plate to an upright position.
3. Place the filter plate against the bench surface and peel off the top seal.
4. Position the filter plate on top of a collection plate.  
*Note: Remember to change or empty the collection plate as necessary during the following steps.*
5. Centrifuge the filter plate for 2 min at  $500 \times g$  to remove the ethanol storage solution from the medium.
6. Add 500  $\mu\text{L}$  of deionized water to each well. Centrifuge the plate for 2 min at  $500 \times g$ .
7. Add 500  $\mu\text{L}$  of binding buffer to each well to equilibrate the medium. Centrifuge for 2 min at  $500 \times g$ . Repeat once. The filter plate is now ready for use.

 Blank run: Reducing agents may be used in sample and buffers. In such a case, perform a blank run by applying 500  $\mu\text{L}$  of elution buffer/well before step 7. **No reducing agent should be used in buffer during blank runs.** Reequilibrate with binding buffer that includes reducing agent before sample application. Do not leave His MultiTrap plates with buffers that include reducing agents when not in use.


## Centrifugation procedure

 Do not apply more than  $700 \times g$  during centrifugation.

1. Apply unclarified or clarified lysate (maximum 600  $\mu\text{L}$  per well) to the wells of the filter plate and incubate for 3 min.  
*Note: If the yield of protein is too low, increase the incubation time and/or gently agitate the filter plate to suspend the medium in the sample solution.*
2. Centrifuge the plate at  $100 \times g$  for 4 min or until all the wells are empty. Discard the flowthrough.
3. Add 500  $\mu\text{L}$  of binding buffer per well to wash out any unbound sample. Centrifuge at  $500 \times g$  for 2 min. Repeat once or until all unbound sample is removed.  
*Note: Removal of unbound material can be monitored as  $A_{280}$ . For high purity,  $A_{280}$  should be  $< 0.1$ .*
4. Add 200  $\mu\text{L}$  of elution buffer per well and mix for 1 min.  
*Note: The volume of elution buffer can be varied (50 to 200  $\mu\text{L}$  per well), depending on the concentration of target protein required. Volumes in the collection plate that are too small may give inaccurate absorbance values.*
5. Change the collection plate and centrifuge at  $500 \times g$  for 2 min to collect the eluted protein. Repeat twice or until all the target protein has been eluted.  
*Note: The yield can usually be monitored for each fraction as  $A_{280}$  reading. If uncertain of required volume, change the collection plate between each elution to prevent unnecessary dilution of the target protein.*



## Vacuum procedure for high-throughput screening


 If problems with foaming, reproducibility, or bubbles in the collection plate occur using vacuum, the centrifugation procedure should be considered. The distance between the filter plate and the collection plate is critical; reduce the distance to 5 mm if necessary.

### Preparing the 96-well filter plate



1. Peel off the bottom seal from the 96-well filter plate. Be sure to hold the filter plate over a sink to accommodate any leakage of storage solution when removing the bottom seal.
2. Hold the filter plate upside down and gently shake it to dislodge any medium adhering to the top seal. Return the filter plate to an upright position.
3. Place the filter plate against the bench surface and peel off the top seal.
4. Position the filter plate on top of a collection plate.

*Note: Remember to change or empty the collection plate as necessary during the following steps.*

5. Set the vacuum to -0.15 bar. Place the 96-well plate and collection plate on the vacuum manifold to remove the ethanol storage solution from the medium.
6. Add 500  $\mu$ L of deionized water to each well. Apply vacuum to drain the water from the wells.
7. Add 500  $\mu$ L of binding buffer to each well to equilibrate the medium. Remove the solution as in step 5. Repeat once. The filter plate is now ready for use.

 Blank run: Reducing agents may be used in sample and buffers. In such a case, run a blank run by applying 500  $\mu$ L of elution buffer/well before step 7. **No reducing agent should be used in buffer during blank runs.** Reequilibrate with binding buffer that includes reducing agent before sample application. Do not leave His MultiTrap plates with buffers that include reducing agents when not in use.


## Vacuum procedure

-  Do not apply a pressure in excess of -0.5 bar during vacuum operation.
-  If a robotic system is used for purification, the vacuum must be adjusted according to methods applicable to the system.

1. Apply unclarified or clarified lysate (maximum 600  $\mu$ L per well) to the wells of the filter plate and incubate for 3 min.

*Note: If the yield of protein is too low, increase the incubation time and/or gently agitate the filter plate.*

2. Remove the flowthrough by applying a vacuum of -0.15 bar until all the wells are empty. Slowly increase the vacuum to -0.30 bar and turn off the vacuum after approximately 5 sec. Discard the flowthrough.

 Increasing the vacuum too quickly can result in foaming under the filter plate and subsequent cross-contamination of samples.



3. Add 500  $\mu\text{L}$  of binding buffer per well to wash out any unbound sample. Apply a vacuum of -0.15 bar as in step 2. Repeat once or until all unbound sample is removed.

*Note: Removal of unbound material can be monitored as  $A_{280}$ . For high purity,  $A_{280}$  should be  $< 0.1$ .*

4. Add 200  $\mu\text{L}$  of elution buffer per well and mix for 1 min.

*Note: The volume of elution buffer can be varied (50 to 200  $\mu\text{L}$  per well), depending on the concentration of target protein required. Volumes in the collection plate that are too small may give inaccurate absorbance values.*

5. Change the collection plate and apply a vacuum of -0.15 bar to collect the eluted protein. Repeat twice or until all the target protein has been eluted.

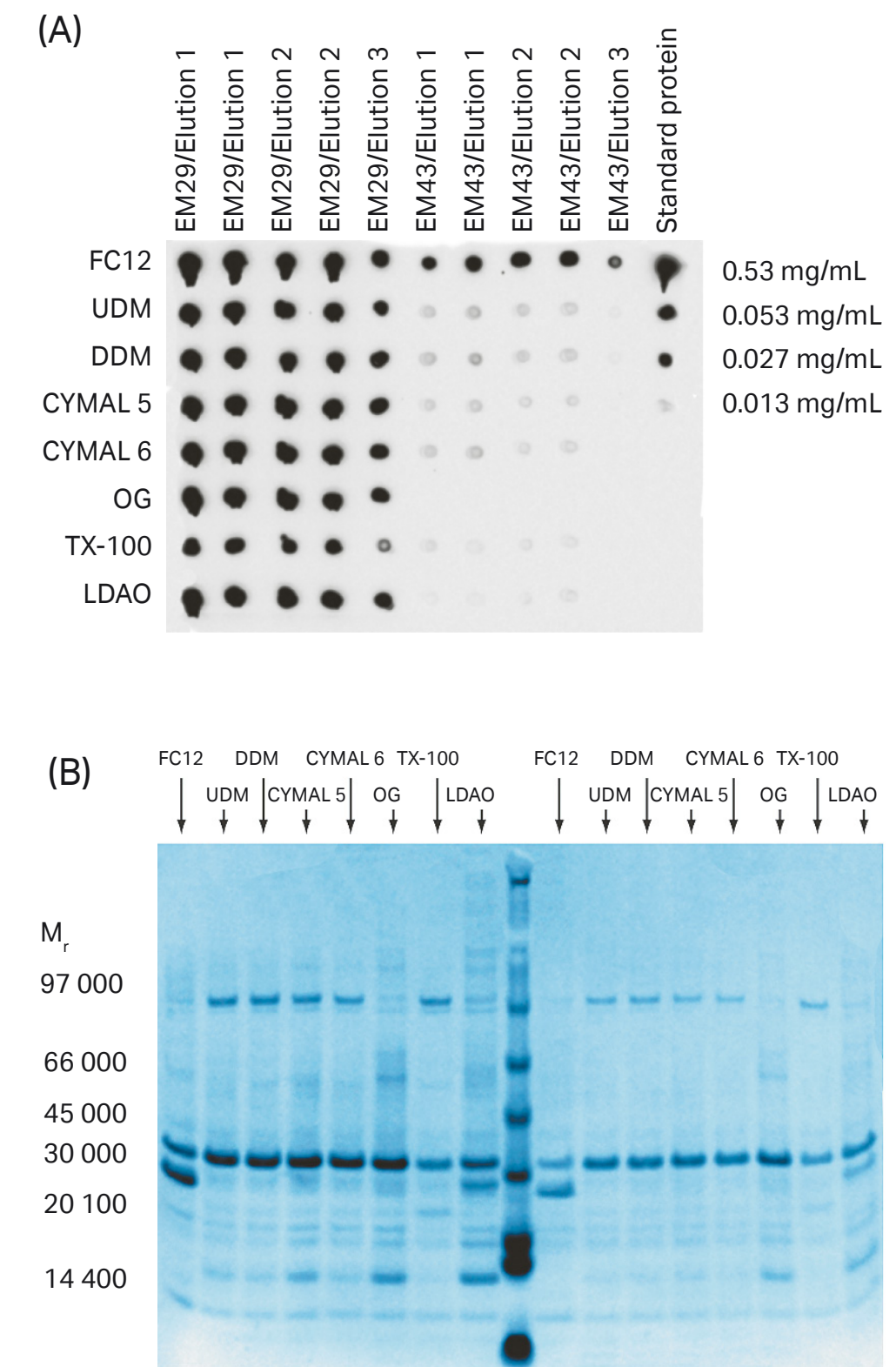
*Note: The yield can usually be monitored for each fraction as  $A_{280}$  reading. If uncertain of required volume, change the collection plate between each elution to prevent unnecessary dilution of the target protein.*

## Application example

### Determining solubility effects of detergents in buffers during purification of membrane proteins using His MultiTrap FF

The 96-well filter plate format of His MultiTrap FF and His MultiTrap HP allows high-throughput screening and purification of histidine-tagged proteins. In this example, His MultiTrap FF was used to screen eight detergents for their effect on the solubility of six histidine-tagged membrane proteins. Results from purification screening of two proteins, GlpG protein (EM29) and cation transporter (EM43), are shown in a dot blot and SDS-PAGE in Figure 3.7. The results show that conditions to find the most appropriate detergent for the membrane proteins in the study can be readily optimized, with high reproducibility, using MultiTrap 96-well filter plate.

**96-well filter plate:** His MultiTrap FF  
**Sample:** Six *E. coli* lysates containing histidine-tagged membrane proteins: probable transporter, ion transporter, putative transferase, regulatory protein, GlpG protein, and cation transporter; GlpG protein (EM29) and cation transporter (EM43) are shown here  
**Sample preparation:** Chemical and freeze/thaw lysis  
**Sample volume:** 100  $\mu$ L/well  
**Elution method:** Centrifugation  
**Elution volume:** 3  $\times$  50  $\mu$ L/well  
**Lysis buffer:** 20 mM sodium phosphate, pH 7.4, 100 mM sodium chloride, 20 mM imidazole, 0.5 mM TCEP, 5 U/mL Benzonase™ Nuclease, 1 mg/mL lysozyme, EDTA-free protease inhibitor cocktail, 1% to 2% detergent, and 1 $\times$  BugBuster™ Protein Extraction Reagent  
**Binding buffer:** 20 mM sodium phosphate, pH 7.4, 500 mM sodium chloride, 20 mM imidazole, 0.5 mM TCEP, 1%–2% detergent  
**Wash buffer:** 20 mM sodium phosphate, pH 7.4, 500 mM sodium chloride, 40 mM imidazole, 0.5 mM TCEP, 0.03% DDM, 1%–2% detergent  
**Elution buffer:** 20 mM sodium phosphate pH 7.4, 500 mM sodium chloride, 500 mM imidazole, 0.5 mM TCEP, 0.03% DDM, 1%–2% detergent  
**Detergents:** 1% Fos-Choline 12 (FC12), 1% undecyl maltoside (UDM), 1% dodecyl maltoside (DDM), 1% CYMAL™-5, 1% CYMAL-6, 2% octyl glucoside (OG), 1% Triton™ X-100 (TX-100), 1% lauryl dimethylamine oxide (LDAO)  
**Data evaluation:** Dot-blot analysis on nitrocellulose membrane. Histidine-tagged proteins were detected using HisProbe™-HRP chemistry. SDS-PAGE with Coomassie staining

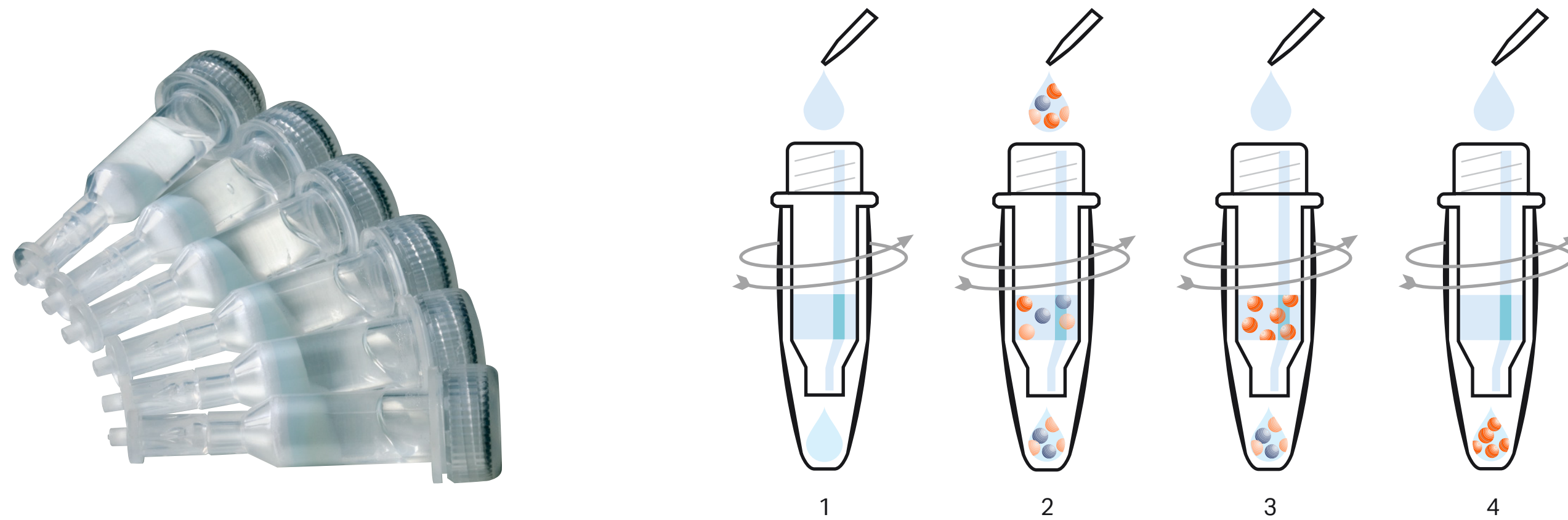


**Fig 3.7.** (A) Dot blot of membrane proteins EM29 and EM43 purified on His MultiTrap FF in the presence of different detergents. Repeats of eluates 1 and 2 shown in the dot blot are two independent extractions and purifications. (B) SDS-PAGE (Coomassie staining) of EM29 purifications (elutions 1 and 2 in the blot) with eight different detergents on His MultiTrap FF. Data kindly provided by S. Eshagi, V. Lieu, P. Nordlund, Dept. of Medical Biochemistry and Biophysics, Karolinska Institute, Stockholm, Sweden.

## Minipreps using His SpinTrap and His SpinTrap Kit

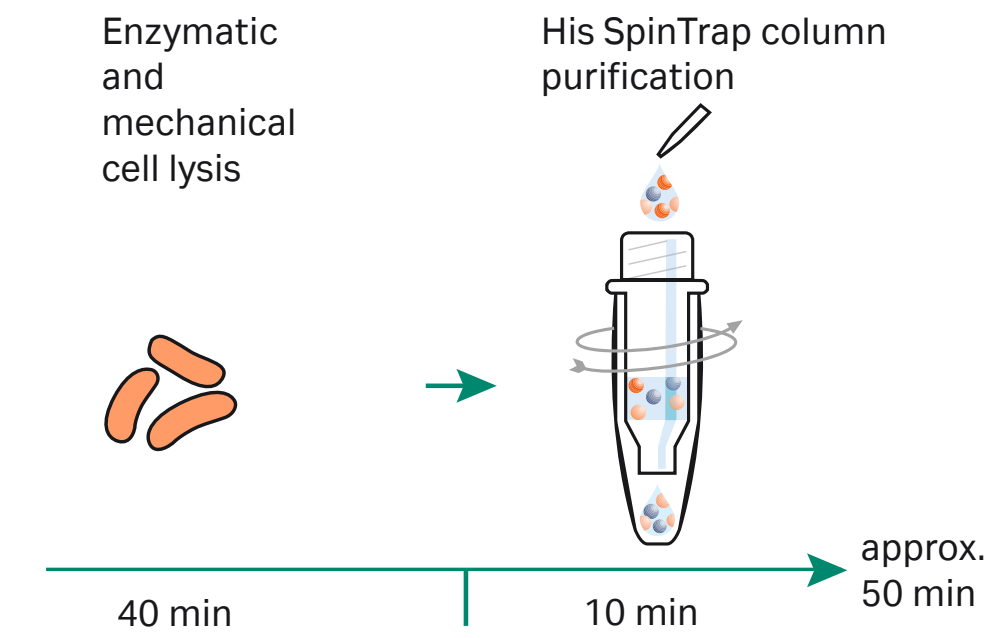
His SpinTrap and His SpinTrap Kit are designed for efficient minipreps (small-scale purification) of histidine-tagged proteins directly from clarified or unclarified cell lysates. The columns may also be used for screening of large numbers of small-scale lysates, as well as optimization of purification conditions. Purification is done in batch mode (by suspension of the medium in the applied sample). The columns are prepacked with Ni Sepharose High Performance. See Appendix 1 for the main characteristics of His SpinTrap.

His SpinTrap columns are used together with a standard microcentrifuge. One purification run takes approximately 10 min. For optimal performance, use His SpinTrap together with buffers prepared using His Buffer Kit. His Buffer Kit is included in His SpinTrap Kit. Purification of unclarified samples on His SpinTrap columns minimizes loss of target protein caused by manual operations such as sample precentrifugation, transfer to centrifugation tubes, and collecting supernatant. In addition, loading unclarified sample directly to the His SpinTrap columns reduces sample preparation time, which minimizes degradation of sensitive target proteins. See Figures 3.8 and 3.9 for schematics showing the procedure.

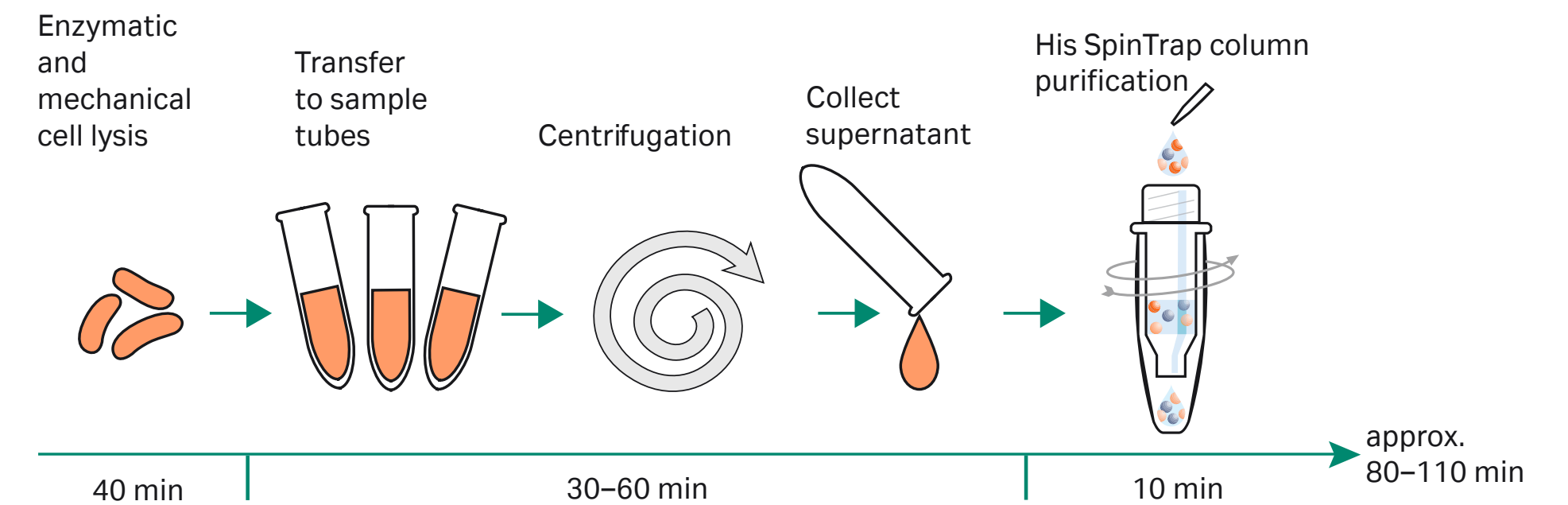


**Fig 3.8.** His SpinTrap is a single-use column for simple, small-scale purification of histidine-tagged proteins and rapid expression screening. Purifying histidine-tagged proteins with His SpinTrap is a simple, four-stage procedure that can be performed in 10 min using a microcentrifuge: (1) After placing the column in a 2 mL microcentrifuge tube, equilibrate by adding binding buffer and centrifuge; (2) add sample; (3) wash with binding buffer; (4) elute the target protein with elution buffer.

### Unclarified sample



### Clarified sample



**Fig 3.9.** Total times for preparing and purifying unclarified samples are 30 to 60 min less than for clarified samples because the extra time needed to clarify the cell lysate by centrifugation is eliminated.



## Cell lysis

The procedure below has been used successfully in our own laboratories for sample preparation prior to use of His SpinTrap, but other established procedures may also work. Use standard 2 mL microcentrifuge tubes.


1. Dilute the cell paste: Add 1 mL of binding buffer to resuspend cell paste obtained from 20 to 50 mL of cell culture (depending on expression level).

 To prevent the binding of host cell proteins with exposed histidines, it is essential to include imidazole at a low concentration in the sample and binding buffer (see Chapter 4).

- 2a. Enzymatic lysis: Add 0.2 mg/mL lysozyme, 20 µg/mL DNase, 1 mM MgCl<sub>2</sub>, and 1 mM Pefabloc SC or PMSF. Vortex the tubes gently and incubate at room temperature for 30 min.


 Chemical lysis kits can also be used, but make sure that they do not contain any chelating agent.

- 2b. Mechanical lysis: Disrupt cells by repeated freeze/thaw, homogenization, or sonication.

 You can also apply clarified sample to the column by spinning at full speed in a microcentrifuge for 10 min to remove insoluble material. Collect supernatant and purify on His SpinTrap.

## Sample and buffer preparation


Refer to *Purification using Ni Sepharose High Performance* earlier in this chapter, for a general procedure for sample and buffer preparation.

 Recommended buffers for native conditions can easily be prepared from His Buffer Kit, which is included in His SpinTrap Kit.

## Purification

Perform purifications on His SpinTrap using a standard microcentrifuge. Place the column in a 2 mL microcentrifuge tube to collect the liquid during centrifugation. Use a new 2 mL tube for every step (steps 1 to 6).

1. Invert and shake the column repeatedly to resuspend the medium. Loosen the top cap one-quarter of a turn and break off the bottom closure.
2. Place the column in a 2 mL microcentrifuge tube and centrifuge for 30 s at 70 to 100 × g (approx. 1000 rpm in an Eppendorf™ 5415R, 24-position fixed-angle rotor) to remove the storage liquid.
3. Remove and discard the top cap. Equilibrate the column by adding 600 µL of binding buffer. Centrifuge for 30 s at 70 to 100 × g.
4. Add up to 600 µL (total) of prepared sample. Centrifuge for 30 s at 70 to 100 × g.

 You can make several sample applications as long as you do not exceed the binding capacity of the column (see Appendix 1).

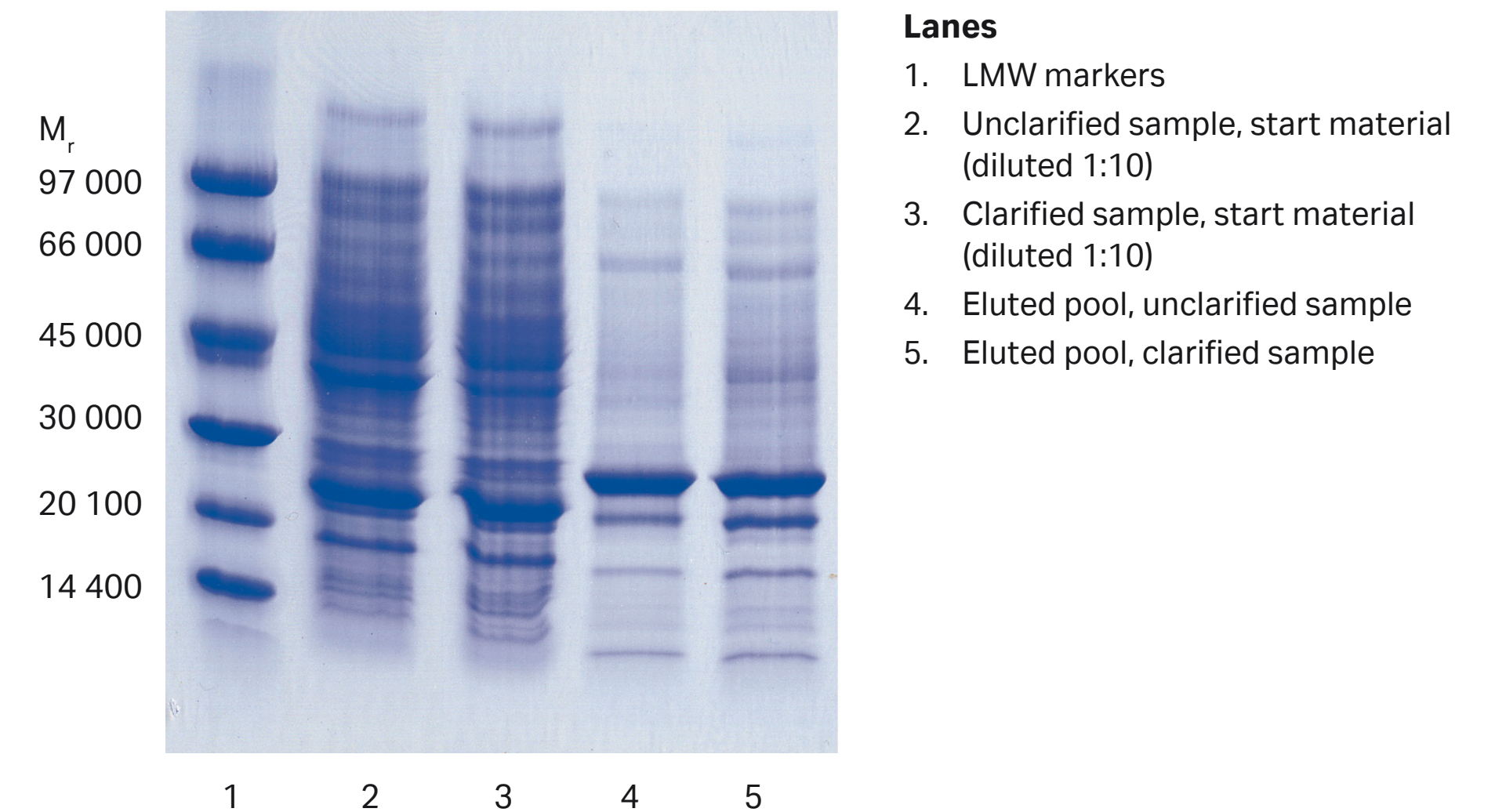
5. Wash with 600 µL of binding buffer. Centrifuge at 70 to 100 × g for 30 s. Repeat the wash step after sample application if required to obtain sufficient purity.
6. Elute the target protein twice with 200 µL of elution buffer. Centrifuge for 30 s at 70 to 100 × g and collect the purified sample. The first 200 µL will contain most of the target protein.

## Application example

### Purification of unclarified sample using His SpinTrap

The performance of His SpinTrap columns in purifying a histidine-tagged protein from unclarified *E. coli* lysate was assessed. Histidine-tagged green fluorescent protein, GFP-(His)<sub>6</sub>, in *E. coli* BL-21 lysate, was subjected to enzymatic lysis followed by sonication for 10 min, and the unclarified lysate was loaded directly on His SpinTrap. For comparison, half of the sample was also clarified by centrifugation before purification. Samples and binding buffer contained 60 mM imidazole. To ensure complete elution of GFP-(His)<sub>6</sub>, which has a high affinity for Ni Sepharose High Performance, the elution buffer contained 800 mM imidazole rather than the more usual 500 mM. Purification time for the unclarified and clarified sample was 10 min. The final purity of eluates from unclarified and clarified samples was similar as confirmed by SDS-PAGE (Fig 3.10).

<i>Column:</i>	His SpinTrap
<i>Equilibration:</i>	600 µL binding buffer
<i>Sample application:</i>	600 µL unclarified or clarified <i>E. coli</i> BL-21 lysate containing 150 µg GFP-(His) <sub>6</sub>
<i>Wash:</i>	600 µL binding buffer
<i>Elution:</i>	2 × 200 µL elution buffer
<i>Binding buffer:</i>	20 mM sodium phosphate, 500 mM NaCl, 60 mM imidazole, pH 7.4
<i>Elution buffer:</i>	20 mM sodium phosphate, 500 mM NaCl, 800 mM imidazole, pH 7.4



**Fig 3.10.** SDS-PAGE (ExcelGel™ SDS Gradient 8–18) under reducing conditions of unclarified and clarified *E. coli* lysate containing GFP-(His)<sub>6</sub>. Similar purity and recovery were observed for both unclarified and clarified sample.



## Purification using HisTrap HP and HisTrap FF

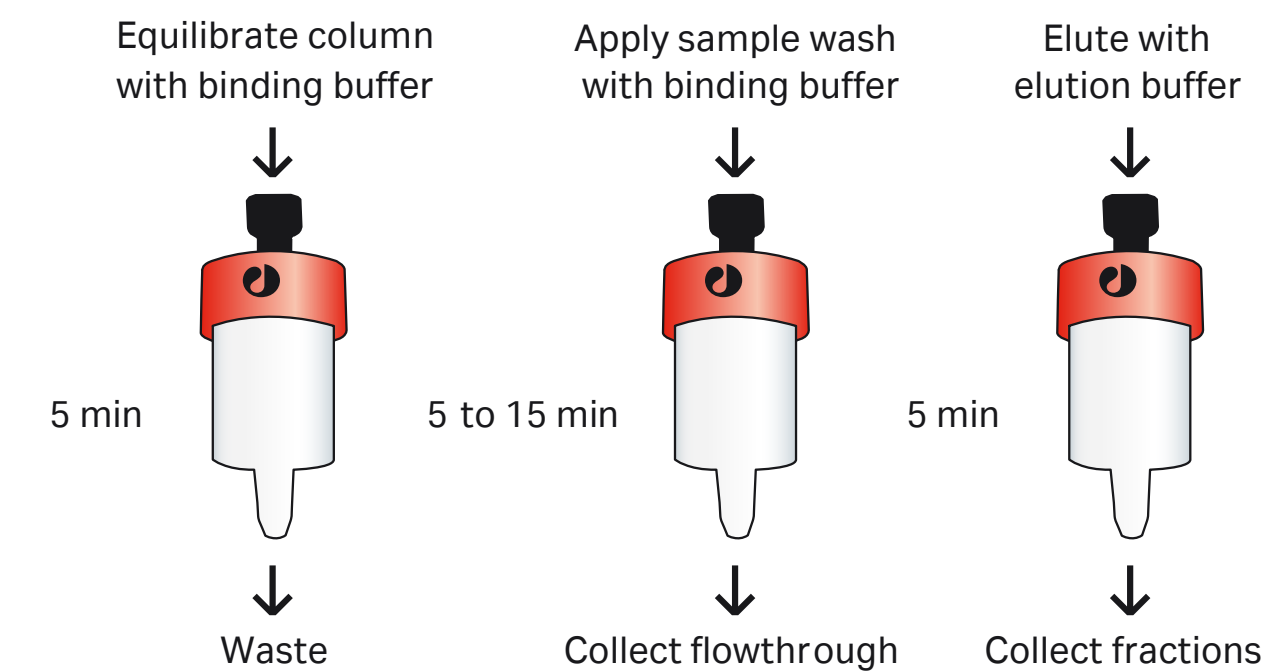
HisTrap HP and HisTrap FF are 1 mL and 5 mL HiTrap columns packed with Ni Sepharose High Performance or Ni Sepharose 6 Fast Flow, respectively. Sample application, washing, and elution can be performed using a syringe with a supplied adapter, a peristaltic pump, or a liquid chromatography system such as ÄKTA (see Chapter 2, Table 2.1 for equipment choices).

HisTrap HP and HisTrap FF columns are made of polypropylene, which is biocompatible and non-interactive with biomolecules. The top and bottom frits are manufactured from porous polyethylene. Columns are delivered with a stopper on the inlet and a snap-off end on the outlet. Every package includes all necessary components for connection of the columns to different types of equipment. For quick scale-up of purifications, two or three HisTrap columns (1 mL or 5 mL) can be connected in series (back pressure will be higher). Note that HisTrap HP and HisTrap FF columns cannot be opened or refilled.

### Sample and buffer preparation

HisTrap HP: refer to *Purification using Ni Sepharose High Performance* earlier in this chapter for a general procedure for sample and buffer preparation.

HisTrap FF: refer to *Purification using Ni Sepharose 6 Fast Flow* earlier in this chapter for a general procedure for sample and buffer preparation.




**Fig 3.11.** HisTrap HP and HisTrap FF 1 mL and 5 mL columns allow convenient and simple one-step purification of histidine-tagged proteins. HisTrap HP 1 mL and 5 mL columns are shown here. The simple purification scheme is shown at right.





## Purification

1. Fill the syringe or pump tubing with distilled water. Remove the stopper and connect the column to the syringe (use the connector supplied), laboratory pump, or chromatography system "drop to drop" to avoid introducing air into the system.
2. Remove the snap-off end at the column outlet.
3. Wash out the ethanol with 3 to 5 column volumes of distilled water.
4. Equilibrate the column with at least 5 column volumes of binding buffer. Recommended flow rates are 1 mL/min (1 mL column) and 5 mL/min (5 mL column).
5. Apply the pretreated sample using a syringe fitted to the Luer connector or by pumping it onto the column. For best results, use a flow rate of 0.2 to 1 mL/min (1 mL column) and 0.5 to 5 mL/min (5 mL column) during sample application<sup>1</sup>.
6. Wash with binding buffer (generally at least 5 to 10 column volumes) until the absorbance reaches a steady baseline or no material remains in the effluent. Maintain a flow rate of 1 to 2 mL/min (1 mL column) and 5 to 10 mL/min (5 mL column) for washing.
7. Elute with elution buffer using a one-step or linear gradient. For step elution, 5 column volumes is usually sufficient. For linear gradient elution, 10 to 20 column volumes is usually sufficient. Maintain a flow rate of 1 to 2 mL/min (1 mL column) and 5 to 10 mL/min (5 mL column) for elution.
8. After elution, regenerate the column by washing it with at least 5 column volumes of binding buffer. The column is now ready for a new purification.

<sup>1</sup> One mL/min corresponds to approximately 30 drops/min when using a syringe with a HiTrap 1 mL column, and 5 mL/min corresponds to approximately 120 drops/min when using a HiTrap 5 mL column.

 The column does not need to be stripped and recharged between each purification if the same protein is going to be purified. Reuse of any purification column depends on the nature of the sample and should only be performed with identical tagged proteins to prevent cross-contamination. For more information on this topic and on cleaning and storage, refer to Appendix 1.

 Ni Sepharose is compatible with reducing agents. However, we recommend removal of any weakly bound Ni<sup>2+</sup> ions before applying buffer/sample that includes reducing agents. This can be accomplished by performing a blank run without reducing agents (see below). Do not leave or store HisTrap columns with buffers that include reducing agents.

 Leakage of Ni<sup>2+</sup> from Ni Sepharose is low under all normal conditions. For very critical applications, leakage during purification can be even further diminished by performing a blank run (as described below) before loading sample.

### Blank run:

Use binding buffer and elution buffer **without** reducing agents.

1. Wash the column with 5 column volumes of distilled water (to remove the 20% ethanol).
2. Wash with 5 column volumes of elution buffer.
3. Equilibrate with 10 column volumes of binding buffer.

## Application examples

### 1. Two-step purification of a high-molecular-weight histidine-tagged protein using HisTrap HP

The high-molecular-weight protein histidine-tagged mannanase Man 26A from *Cellulomonas fimi* ( $M_r$  100 000) was purified in its enzymatically active form using a 1 mL HisTrap HP column (Fig 3.12A). A second purification step using SEC with Superdex™ 200 (24 mL column volume) was added to obtain a purity of 95% (Figs 3.12B and 3.12C).

#### (A) AC

**Sample:** 10 mL *E. coli* extract with low-level expression of a histidine-tagged mannanase, Man 26A, from *Cellulomonas fimi* ( $M_r$  ~ 100 000)

**Column:** HisTrap HP 1 mL

**Binding buffer:** 20 mM sodium phosphate, 30 mM imidazole, 500 mM NaCl, pH 7.4

**Elution buffer:** 20 mM sodium phosphate, 500 mM imidazole, 500 mM NaCl, pH 7.4

**Gradient:** 25 mL linear gradient 30–300 mM imidazole

**Flow rate:** 1 mL/min

**System:** ÄKTA

#### (B) SEC

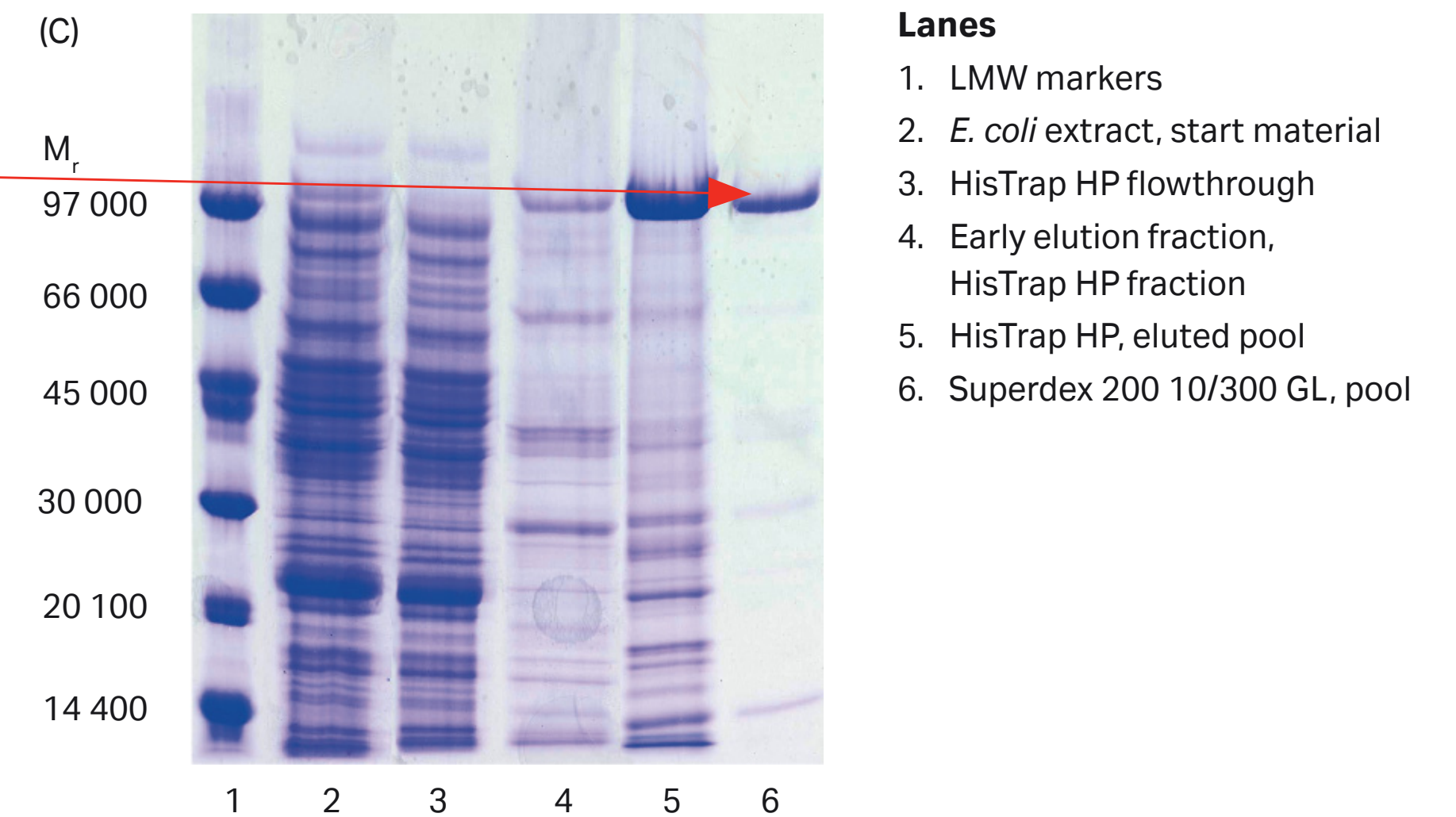
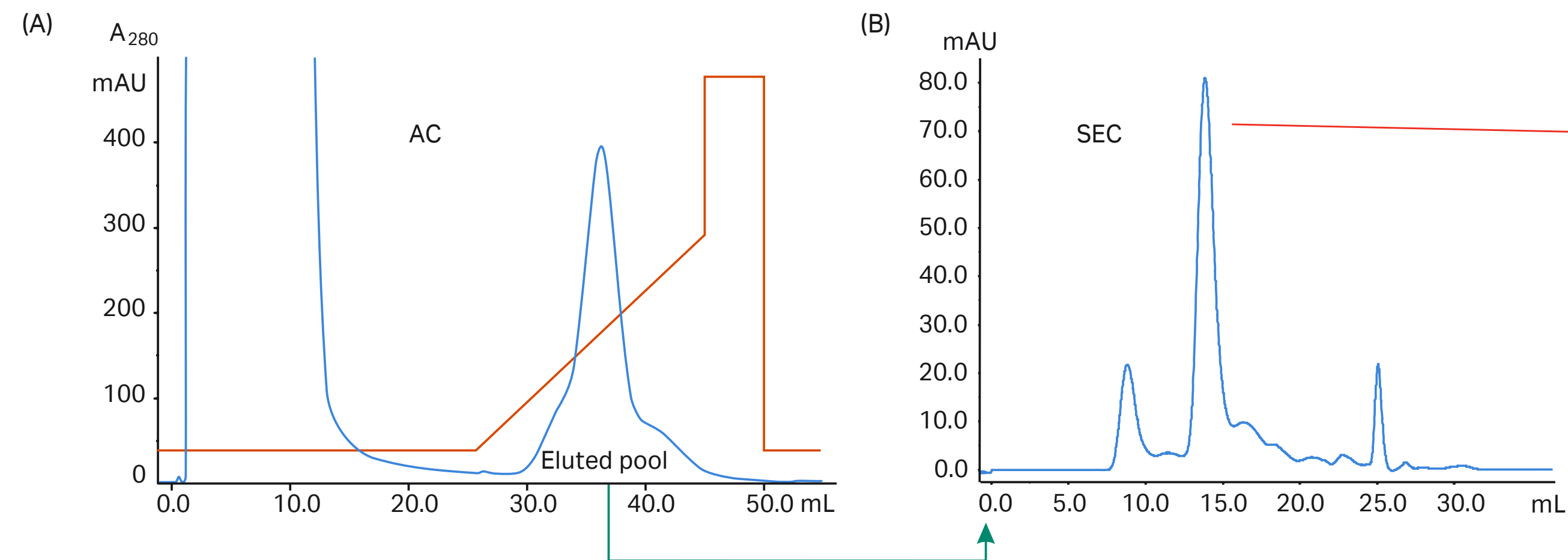
**Sample:** 0.5 mL concentrated sample from HisTrap HP 1 mL column

**Column:** Superdex 200 10/300 GL

**Buffer:** PBS, pH 7.5

**Flow rate:** 0.5 mL/min

**System:** ÄKTA

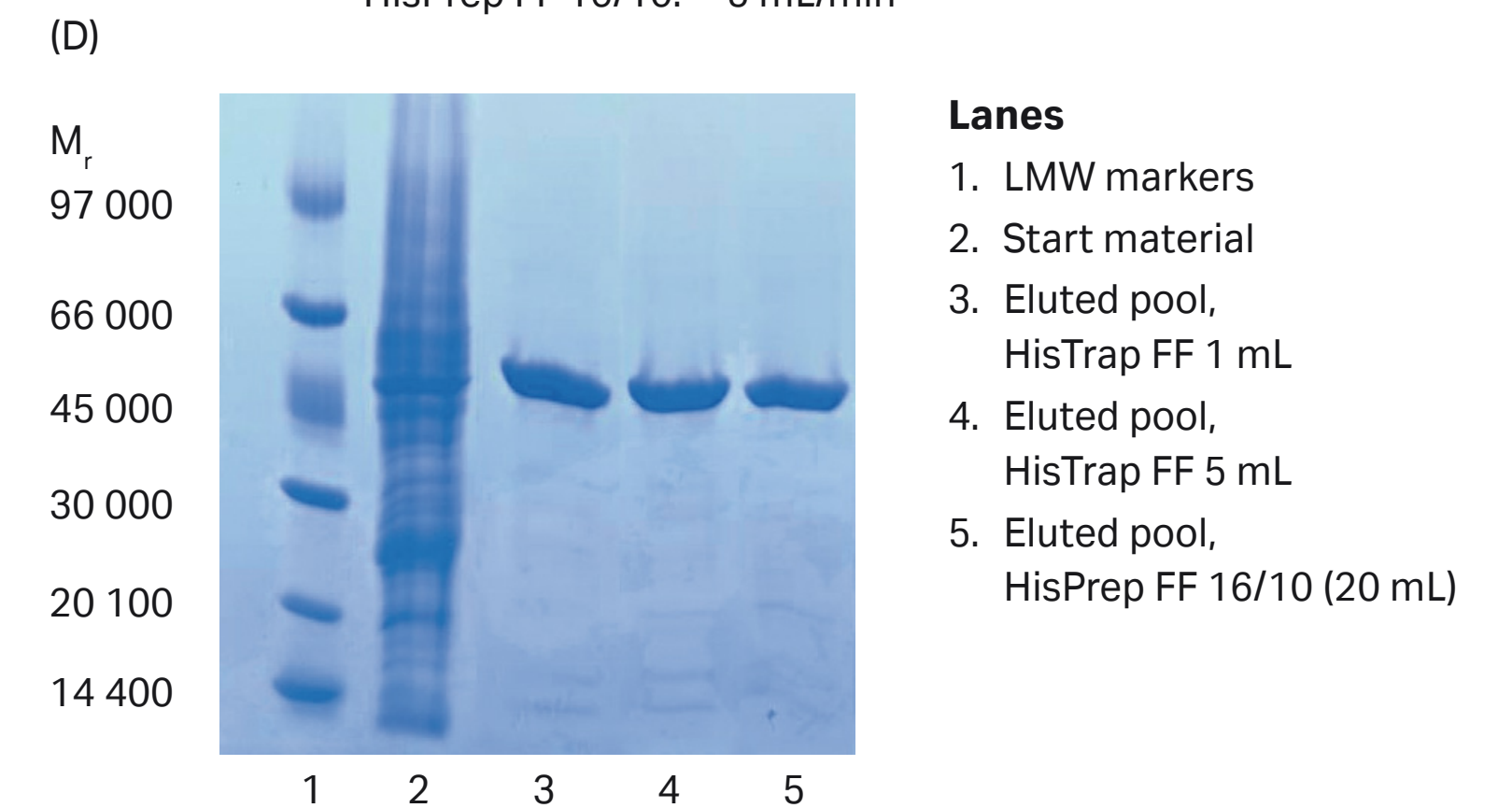
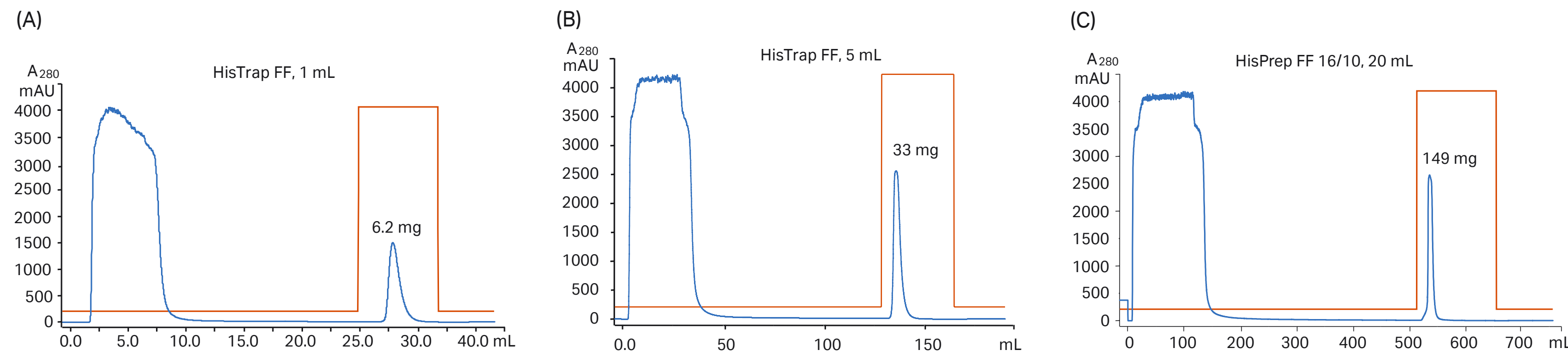


**Fig 3.12.** (A) First purification step, AC, using HisTrap HP 1 mL column. (B) Second purification step with SEC using Superdex 200 30/100 GL. (C) SDS-PAGE.

## 2. Scaling up purification from HisTrap FF to larger scale

Histidine-tagged maltose binding protein MBP-(His)<sub>6</sub> was purified from an *E. coli* extract. Samples containing 8, 40, and 160 mg, were loaded on a 1 mL HisTrap FF column, a 5 mL HisTrap FF column, and a 20 mL HisPrep FF 16/10 column respectively, all of which were run at the same flow velocity. The results show that scaling up the column dimension while running at the same flow velocity provides highly consistent results (Fig 3.13A–C). Pooled fractions were analyzed by SDS-PAGE and showed almost identical results in terms of purity and recovery (Fig 3.13D).

**Columns:** HisTrap FF 1 mL, HisTrap FF 5 mL, HisPrep FF 16/10 (20 mL)  
**Sample:** Histidine-tagged Maltose Binding Protein, MBP-(His)<sub>6</sub>, in *E. coli* extract  
**Binding buffer:** 20 mM sodium phosphate, 25 mM imidazole, 500 mM NaCl, pH 7.4  
**Elution buffer:** 20 mM sodium phosphate, 500 mM imidazole, 500 mM NaCl, pH 7.4  
**Flow rates:** HisTrap FF 1 mL: 1 mL/min  
 HisTrap FF 5 mL: 5 mL/min  
 HisPrep FF 16/10: 5 mL/min




**Fig 3.13.** Scale-up from (A) HisTrap FF 1 mL via (B) HisTrap FF 5 mL to (C) HisPrep 16/10 (20 mL) prepacked column. The samples loaded contained approximately 8, 40, and 160 mg of MBP-(His)<sub>6</sub>, respectively. Recovery in milligrams is shown in each chromatogram. (D) SDS-PAGE (ExcelGel SDS Gradient 8–18) under nonreducing conditions confirms that scaling up from the 1 mL to the 20 mL column does not significantly affect the purification result.



## Purification from unclarified cell lysate using HisTrap FF crude

HisTrap FF crude is a ready-to-use column, prepacked with Ni Sepharose 6 Fast Flow, for purification of histidine-tagged recombinant proteins. After thorough cell disruption, it is possible to load the unclarified, crude cell lysate directly on the column without centrifugation and filtration of the sample.

 Direct loading of unclarified cell lysates decreases the total purification time and may increase the possibility of purifying sensitive target proteins without losing their activity.

HisTrap FF crude columns are made of polypropylene that is biocompatible and does not interact with biomolecules. Columns are delivered with a stopper on the inlet and a snap-off end on the outlet. The columns have porous polyethylene top and bottom frits with a pore size optimized for loading of unclarified cell lysates directly on the column without causing back-pressure problems or leakage of the Ni Sepharose 6 Fast Flow beads. Columns can be operated with a syringe and the supplied Luer connector, a peristaltic pump, or a chromatography system such as ÄKTA. Note that HisTrap FF crude columns cannot be opened or refilled.

See Figure 3.15 for a schematic of the protocol for HisTrap FF crude compared with conventional IMAC.

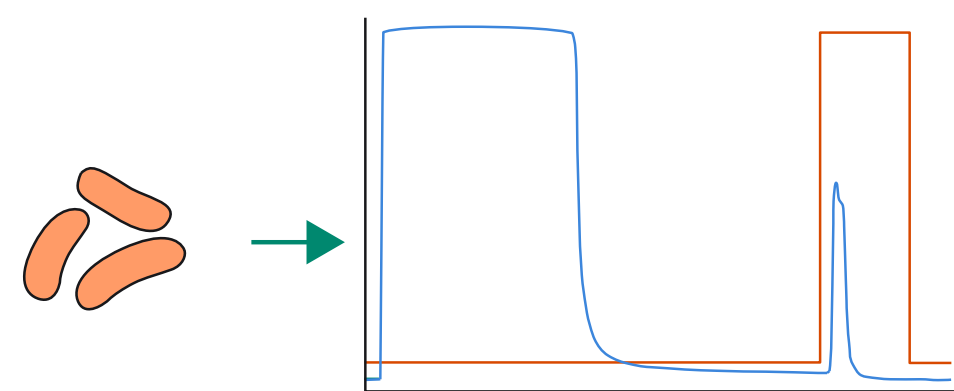


**Fig 3.14.** HisTrap FF crude columns allow simple, one-step purification of histidine-tagged proteins without sample pretreatment such as centrifugation and filtration.

### HisTrap FF crude

Enzymatic and mechanical cell lysis

Purification run



40 min

40 min

Approx. 80 min

### Conventional IMAC

Enzymatic and mechanical cell lysis

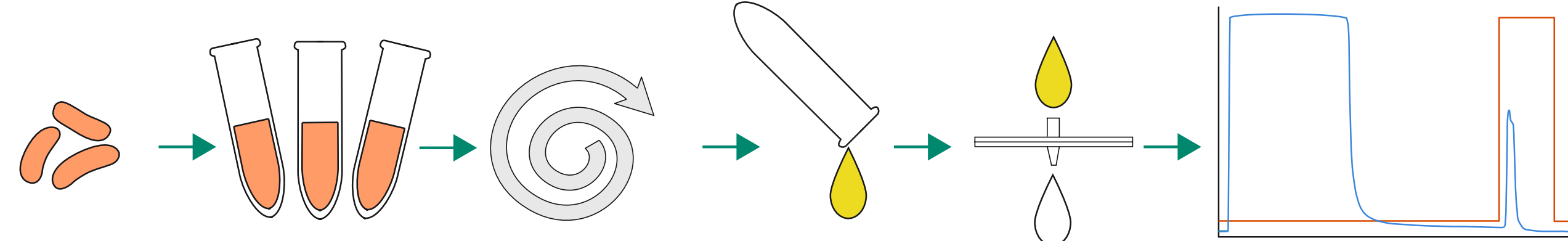
Transfer the sample to tubes

Centrifugation

Collect the supernatant

Filtration of sample

Purification run



40 min

40–80 min




40 min

Approx. 120–160 min

**Fig 3.15.** HisTrap FF crude columns save time during purification of histidine-tagged proteins compared with conventional IMAC.

## Sample and buffer preparation


Refer to *Purification using Ni Sepharose 6 Fast Flow* earlier in this chapter for a general procedure for sample and buffer preparation.

-  For direct loading of an unclarified sample, it is critical to obtain efficient cell lysis in order to avoid problems with back pressure. Apply the unclarified lysate on the column directly after preparation.
-  If the sample is too viscous, dilute it with binding buffer to prevent it from clogging the column; increase lysis treatment (sonication, homogenization); or add DNase/RNase to reduce the size of nucleic acid fragments.
-  If the sonicated or homogenized unclarified cell lysate is frozen before use, precipitation and aggregation may increase. New sonication of the lysate can then prevent increased back-pressure problems when loading on the column.


## Purification


1. Fill the pump tubing or syringe with distilled water. Remove the stopper and connect the column to the chromatography system tubing, syringe (use the provided Luer connector), or laboratory pump “drop to drop” to avoid introducing air into the system.
2. Remove the snap-off end at the column outlet.
3. Wash out the ethanol with 3 to 5 column volumes of distilled water.
4. Equilibrate the column with at least 5 column volumes of binding buffer. Recommended flow rates are 1 mL/min or 5 mL/min for the 1 mL and 5 mL columns, respectively.
5. Apply the unclarified lysate with a pump or syringe. Typical loading volumes of unclarified lysate (highly dependent on specific sample, sample pretreatment, and temperature at sample loading):
  - HisTrap FF crude 1 mL: Up to 100 mL
  - HisTrap FF crude 5 mL: Up to 500 mL


*Note: The protein binding capacity may also limit the amount of sample that can be applied.*


-  Continuous stirring of the sample during sample loading is recommended to prevent sedimentation. Sample loading at 4°C may increase the viscosity of the sample. An adverse effect of increased sample viscosity is that maximum back pressure for the column is reached at a lower sample volume loading on the column. Large volumes may increase back pressure, making the use of a syringe more difficult.

6. Wash with binding buffer until the absorbance reaches a steady baseline (generally at least 10 to 15 column volumes).
7. Elute with elution buffer using a step gradient or a linear gradient. For step elution, 5 column volumes of elution buffer is usually sufficient. A shallow gradient, for example, linear gradient over 20 column volumes or more, can separate proteins with similar binding strengths.
8. After elution, regenerate the column by washing it with 5 to 10 column volumes of binding buffer. The column is now ready for a new purification of the same target protein.

-  The column does not need to be stripped and recharged between each purification if the same protein is going to be purified. Reuse of any purification column depends on the nature of the sample and should only be performed with identical tagged proteins to prevent cross-contamination. For more information on this topic and on cleaning and storage, refer to Appendix 1.

-  Unclarified lysates may cause increased air bubble formation during purification. An attached flow restrictor in the chromatography system can prevent this if it causes problems. If a flow restrictor is attached, it is important to change the pressure limit to 0.5 MPa (5 bar) on the ÄKTA system (where the column and the flow restrictor give a pressure of 0.3 MPa and 0.2 MPa, respectively).

-  Ni Sepharose is compatible with reducing agents. However, we recommend removal of any weakly bound Ni<sup>2+</sup> ions before applying buffer/sample that includes reducing agents. This can be accomplished by performing a blank run without reducing agents (see next page). Do not leave or store HisTrap FF crude columns with buffers that include reducing agents.

-  Leakage of Ni<sup>2+</sup> from Ni Sepharose is low under all normal conditions. For very critical applications, leakage during purification can be even further diminished by performing a blank run (on next page) before loading sample.



### Blank run:

Use binding buffer and elution buffer **without** reducing agents.

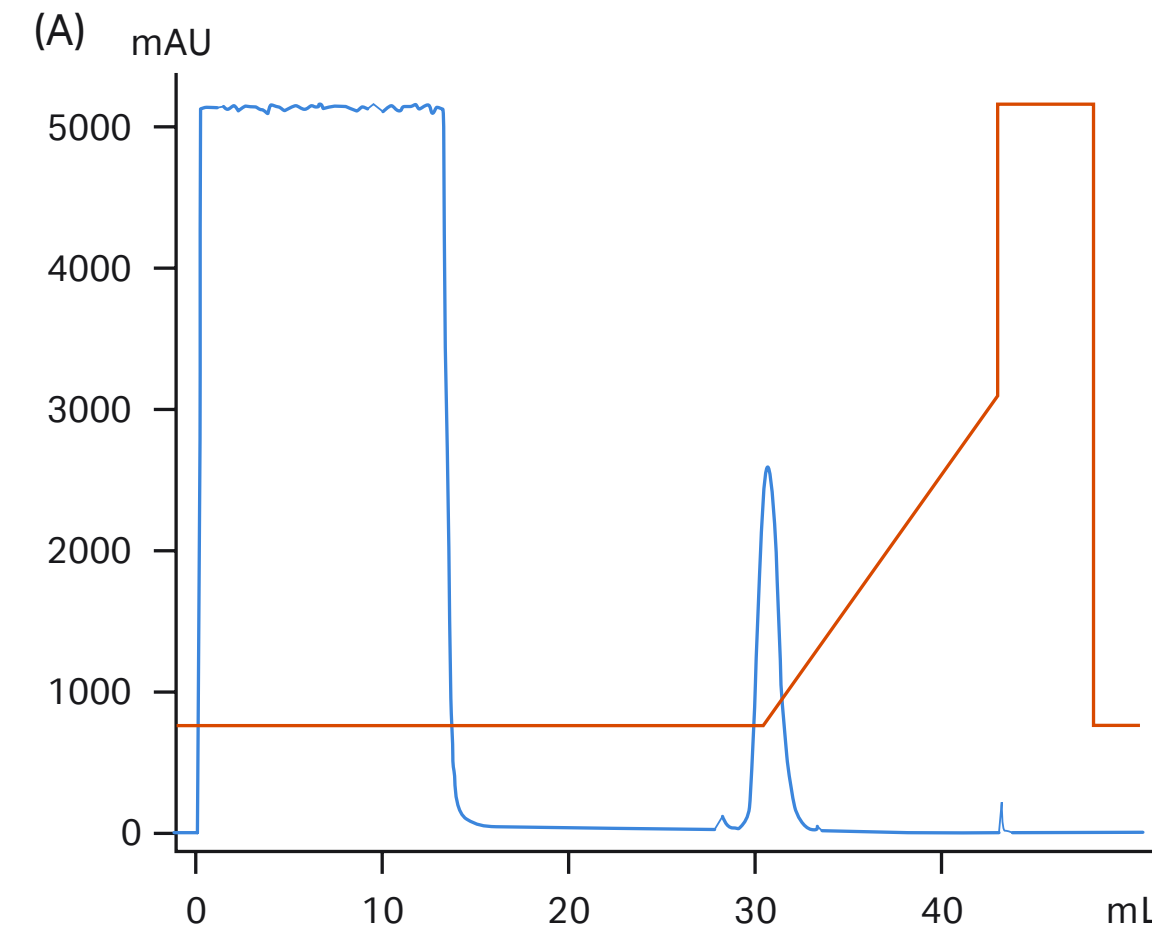
1. Wash the column with 5 column volumes of distilled water (to remove the 20% ethanol).
2. Wash with 5 column volumes of elution buffer.
3. Equilibrate with 10 column volumes of binding buffer.

### Application examples

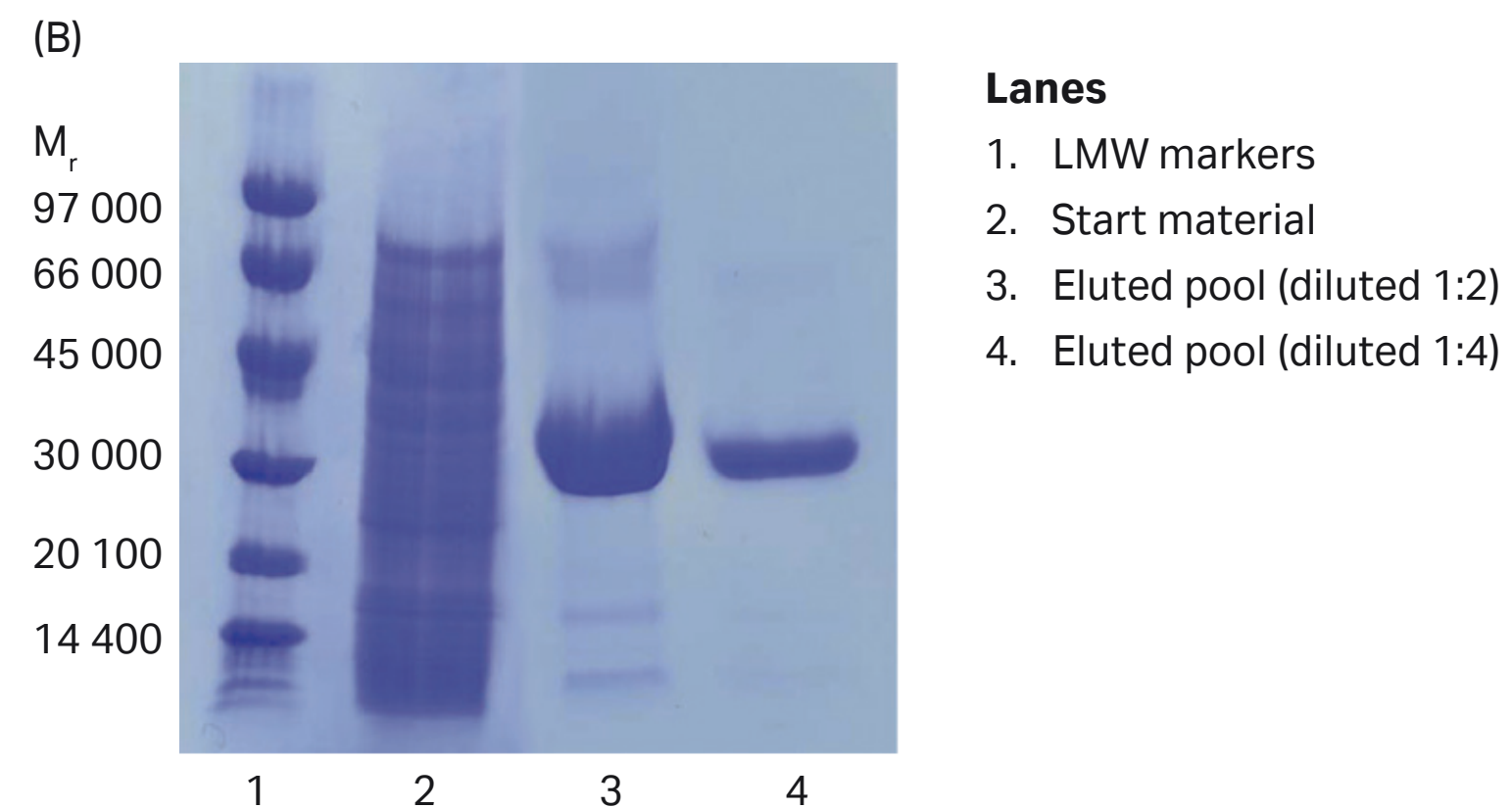
#### 1. Purification of histidine-tagged protein expressed at low levels in *Pichia pastoris* using HisTrap FF crude

HisTrap FF crude columns are well-suited for purification of histidine-tagged proteins expressed at low levels from hosts such as *Pichia pastoris*. Using HisTrap FF crude columns, highly pure protein can be obtained directly from unclarified lysates of *P. pastoris*.

Figure 3.16 shows the purification of a histidine-tagged hydrolase from *Saccharomyces cerevisiae* expressed at low levels in *P. pastoris*. **Unclarified** sample was loaded directly onto a HisTrap FF crude 5 mL column without any centrifugation or filtration of the sample. Purity of the protein from the unclarified sample was high as determined by SDS-PAGE.



**Column:** HisTrap FF crude 5 mL  
**Sample:** Unclarified lysate of YNR064c (*Saccharomyces cerevisiae* hydrolase) expressed in *P. pastoris*  
**Sample volume:** 130 mL  
**Binding buffer:** 20 mM sodium phosphate, 500 mM NaCl, 75 mM imidazole, pH 7.4  
**Elution buffer:** 20 mM sodium phosphate, 500 mM NaCl, 500 mM imidazole, 3 mM KCl, pH 7.4  
**Flow rate:** 5 mL/min  
**System:** ÄKTA



**Fig 3.16.** (A) Purification of an unclarified sample of histidine-tagged hydrolase from *Saccharomyces cerevisiae* expressed in *P. pastoris* on HisTrap FF crude 5 mL. (B) SDS-PAGE under nonreducing conditions (ExcelGel SDS Gradient 8–18) shows the high purity obtained of the low-level expression protein.



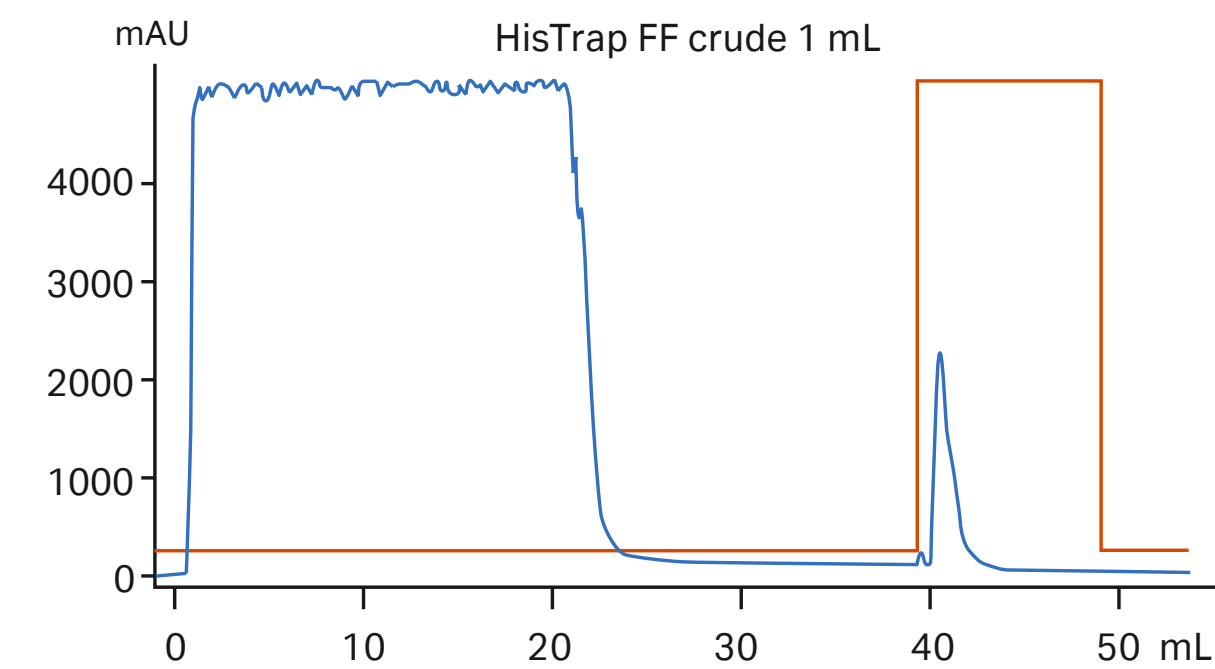
## 2. Scale-up from 1 mL to 5 mL HisTrap FF crude

An experiment was performed to scale up from 1 mL to 5 mL HisTrap FF crude columns. The sample was unclarified *E. coli* extract containing MBP-(His)<sub>6</sub>, which had been prepared by enzymatic lysis in combination with homogenization prior to loading on the column. The samples contained approximately 8 and 40 mg of MBP-(His)<sub>6</sub> for the 1 mL and 5 mL columns, respectively.

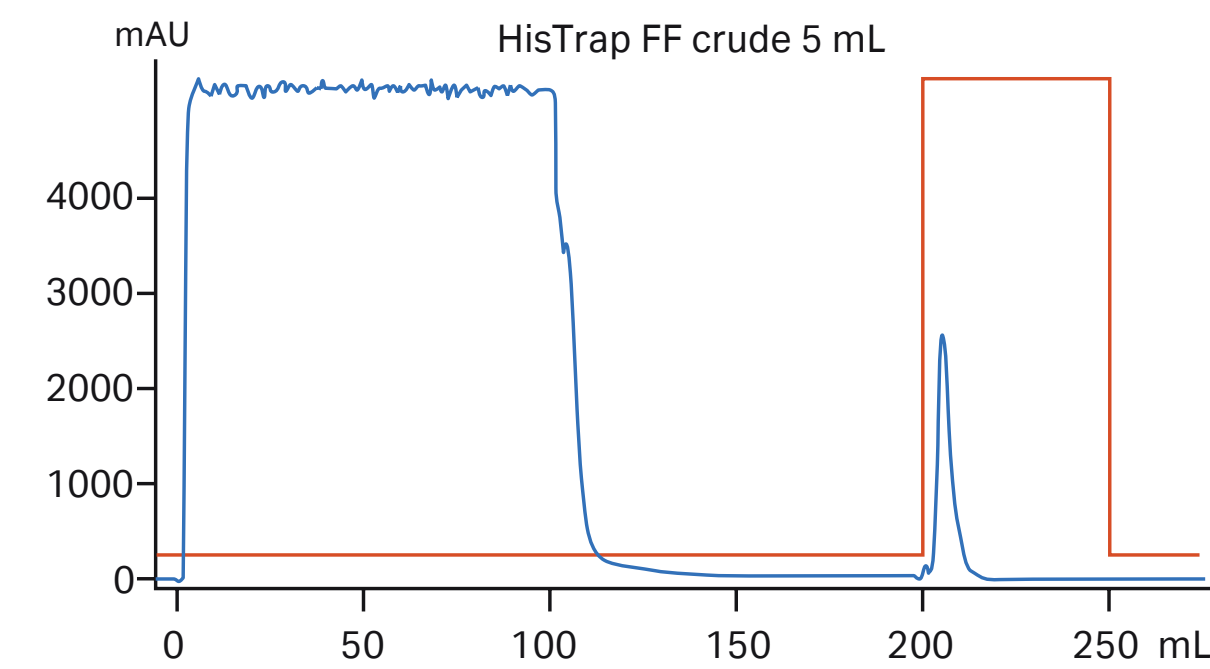
After chromatography (Fig 3.17A and 3.17B), SDS-PAGE analysis was performed. It shows (Fig 3.17C) that the purity and recovery (mg protein/mL medium) of the histidine-tagged protein purified on the two columns was almost identical.

**Column:** HisTrap FF crude columns, 1 mL and 5 mL  
**Sample:** Unclarified *E. coli* BL21 lysate containing MBP-(His)<sub>6</sub>  
**Binding buffer:** 20 mM sodium phosphate, 500 mM NaCl, 25 mM imidazole, pH 7.4  
**Elution buffer:** 20 mM sodium phosphate, 500 mM NaCl, 500 mM imidazole, pH 7.4  
**Flow rate:** HisTrap FF crude 1 mL: 1 mL/min  
HisTrap FF crude 5 mL: 5 mL/min  
**System:** ÄKTA

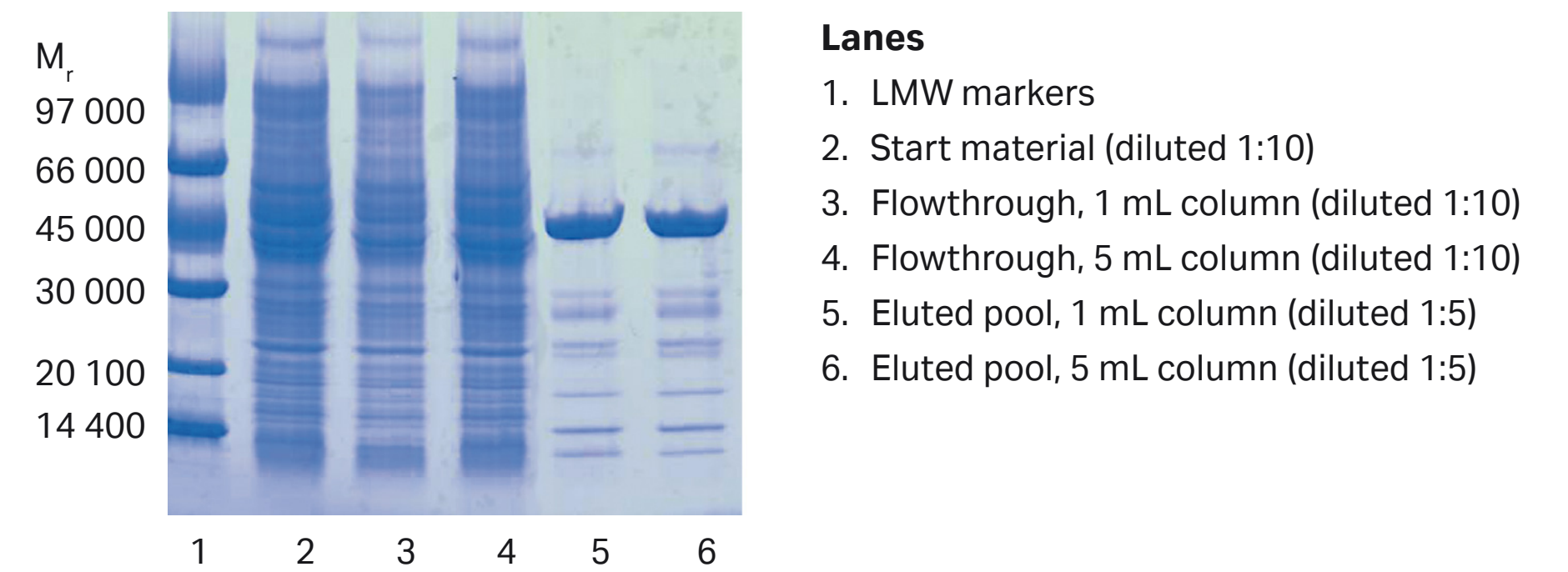
(A)



(B)



(C)



**Fig 3.17.** Scale-up from (A) 1 mL to (B) 5 mL HisTrap FF crude columns. Recovery of protein was 6.3 and 35.2 mg for the 1 mL and 5 mL columns, respectively. (C) SDS-PAGE under nonreducing conditions (ExcelGel SDS Gradient 8–18) confirms that scaling up from the 1 mL to the 5 mL column does not significantly affect the purification result.

### 3. Automated, two-step purification using HisTrap FF crude

HisTrap FF crude columns are well suited to run on ÄKTA systems such as ÄKTExpress for high-throughput purification of histidine-tagged proteins. ÄKTExpress enables automated, parallel purification of histidine-tagged proteins with the capacity to run a number of different multi-step protocols. A method wizard supplied with the UNICORN control software makes it easy to create methods for different purification protocols. Figure 3.18 shows an automated two-step purification of an unclarified lysate of *E. coli* containing MBP-(His)<sub>6</sub>. The first step in the purification protocol was AC, using HisTrap FF crude 1 mL column. The eluted peak from the affinity step was automatically collected in a loop and reinjected onto a HiLoad™ 16/60 Superdex 75 pg SEC column in the second step of the purification. Purity of the protein in fractions from the SEC step was confirmed by SDS-PAGE (Fig 3.18B).

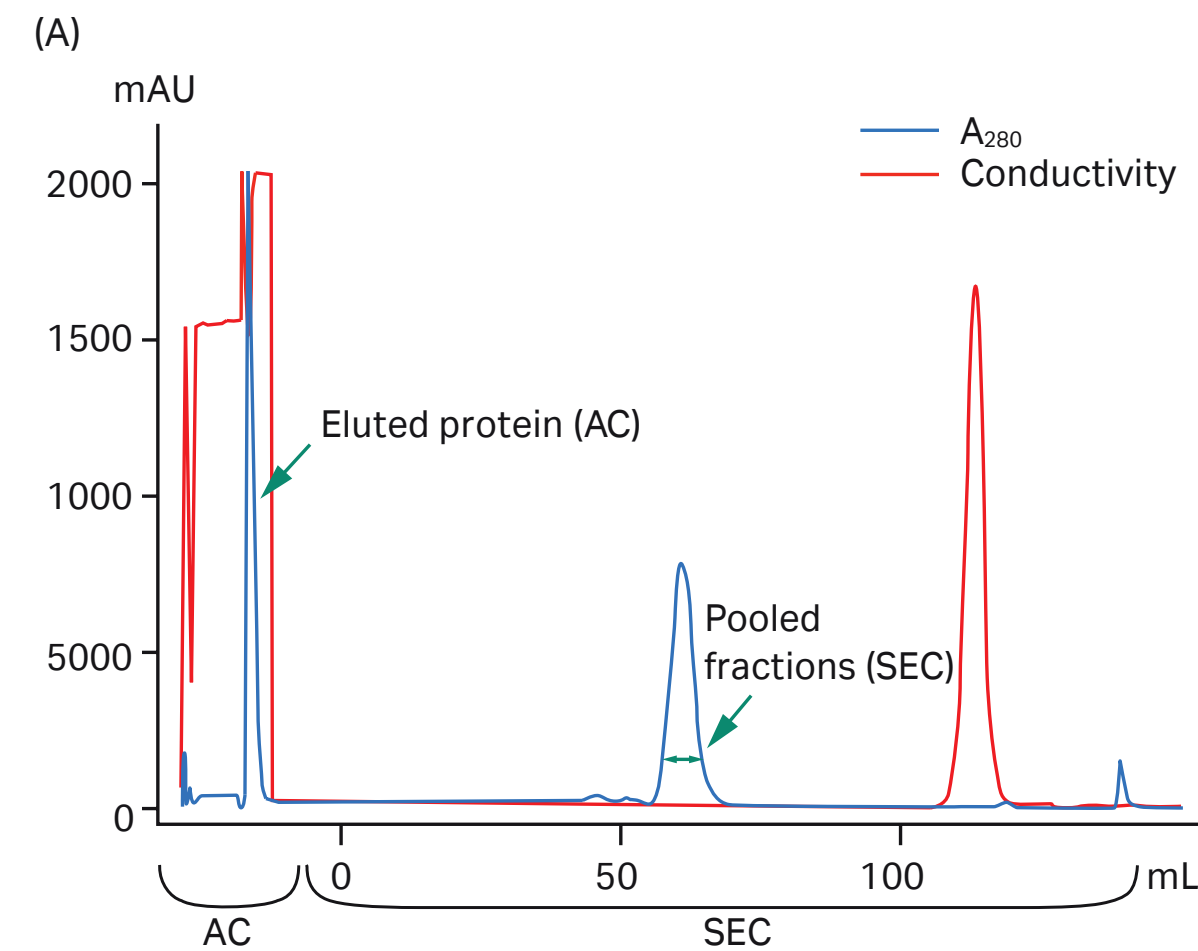
The results show that HisTrap FF crude together with ÄKTExpress facilitates and enables significant time savings in the purification of histidine-tagged proteins without compromising sample purity.

#### AC conditions

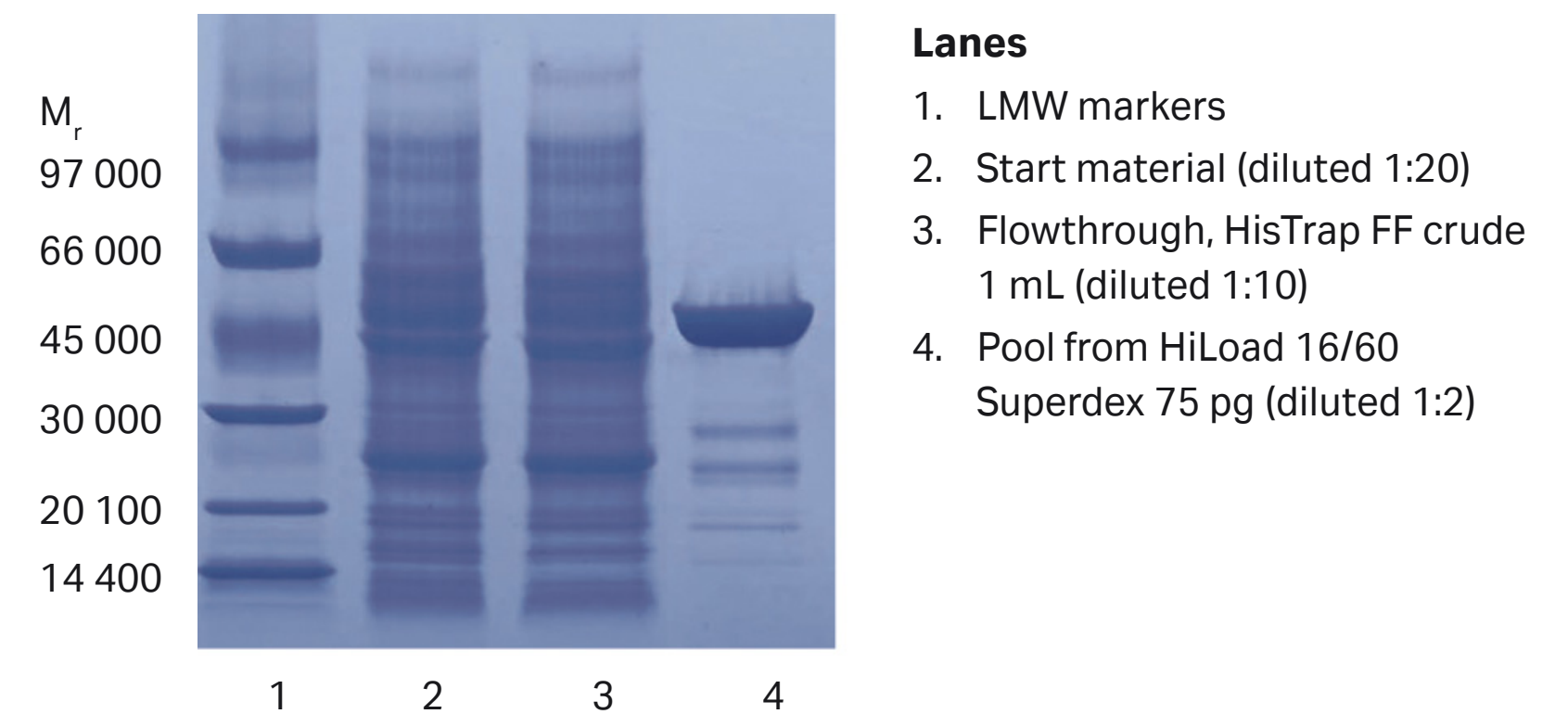
**Column:** HisTrap FF crude 1 mL  
**Sample:** Unclarified *E. coli* BL21 lysate containing MBP-(His)<sub>6</sub>  
**Binding buffer:** 20 mM sodium phosphate, 500 mM NaCl, 25 mM imidazole, pH 7.4  
**Elution buffer:** 20 mM sodium phosphate, 500 mM NaCl, 500 mM imidazole, pH 7.4  
**Flow rate:** 1 mL/min  
**System:** ÄKTExpress

#### SEC conditions

**Column:** HiLoad 16/60 Superdex 75 pg  
**Buffer:** 10 mM sodium phosphate, 140 mM NaCl, 2.7 mM KCl, pH 7.4  
**Flow rate:** 1.5 mL/min  
**System:** ÄKTExpress



#### (B)




**Fig 3.18.** (A) Automated two-step purification of MBP-(His)<sub>6</sub> from an unclarified lysate of *E. coli* using HisTrap FF crude and HiLoad 16/60 Superdex 75 pg on ÄKTExpress. (B) SDS-PAGE was performed under nonreducing conditions on ExcelGel SDS Gradient 8–18.



## Manual purification using HisTrap FF crude Kit with a syringe




HisTrap FF crude Kit is designed for rapid and convenient manual purification of histidine-tagged proteins using premade buffers and a syringe. Histidine-tagged proteins can be purified directly from unclarified cell lysates. This saves time because the pretreatment of the sample is minimized.

The kit contains three ready-to-use 1 mL HisTrap FF crude columns (containing Ni Sepharose 6 Fast Flow), buffer concentrates, a 5 mL syringe, and connectors. The kit provides a sufficient volume of buffer concentrates to perform 10 to 12 purifications when operated with a syringe. The special design of the column, together with Ni Sepharose 6 Fast Flow, provides fast, easy, and reproducible separations in a convenient format. Note that HisTrap FF crude columns cannot be opened or refilled.

 Direct loading of unclarified cell lysates decreases the total purification time and may increase the possibility of purifying sensitive target proteins with retained activity.

### Sample preparation

Refer to *Purification using Ni Sepharose 6 Fast Flow* earlier in this chapter for a general procedure for sample preparation. Information specific to HisTrap FF crude Kit is included on the next page.

-  For direct loading of an unclarified sample, it is critical to obtain efficient cell lysis in order to avoid problems with back pressure. Apply the unclarified lysate on the column directly after preparation.
-  If the sample is viscous, dilute it with binding buffer to prevent it from clogging the column; increase lysis treatment (sonication, homogenization); or add DNase/RNase to reduce the size of nucleic acid fragments.
-  If the sonicated or homogenized unclarified cell lysate is frozen before use, precipitation and aggregation may increase. Samples with precipitation may be sonicated to reduce clogging of the wells. Note that aging of the sample may reduce yields of the target protein.



**Fig 3.19.** HisTrap FF crude Kit provides convenient and simple purification of histidine-tagged proteins.



## Buffer preparation

**Binding buffer:** Mix 3 mL of Phosphate buffer 8× stock solution (included in kit) with 0.24 mL of 2 M imidazole (included in kit) and add water to 24 mL. Check pH and adjust to pH 7.4 to 7.6 if necessary. This buffer now contains 20 mM phosphate, 500 mM NaCl, and 20 mM imidazole.

**Elution buffer:** Mix 1 mL of Phosphate buffer 8× stock solution (included in kit) with 2 mL of 2 M imidazole (included in kit) and add distilled water to 8 mL. Check pH and adjust to pH 7.4 to 7.6 if necessary. This buffer now contains 20 mM phosphate, 500 mM NaCl, and 500 mM imidazole.




 The high salt concentration in the buffer stock solution may cause salt crystals to form at low temperature. These crystals will dissolve at room temperature. We therefore recommend that the buffer stock solutions be allowed to reach room temperature before use. The formation of salt crystals that dissolve at room temperature does not affect the performance of the product. The prepared binding and elution buffers can be used in a cold room as well as at room temperature.

Table 3.2 provides the mixing table for 50 mL of buffer. To obtain the imidazole concentration indicated in the first column, mix Phosphate buffer 8× stock solution, 2 M imidazole, and distilled water according to the table. Check pH and adjust to pH 7.4 to 7.6 if necessary. These buffers will contain 20 mM phosphate, 500 mM NaCl, and the concentrations of imidazole indicated. For one purification, 24 mL of the binding buffer and 8 mL of each elution buffer are sufficient.

 Ni Sepharose is compatible with reducing agents. However, we recommend removal of any weakly bound Ni<sup>2+</sup> ions before applying buffer/sample that includes reducing agents. This can be accomplished by performing a blank run without reducing agents (see next page). Do not store HisTrap FF crude columns with buffers that include reducing agents.

 Leakage of Ni<sup>2+</sup> from Ni Sepharose is very low under all normal conditions. For very critical applications, leakage during purification can be even further diminished by performing a blank run before loading sample.

**Table 3.2.** Mixing table for 50 mL of buffer


Imidazole concentration in buffer (mM)	Phosphate buffer 8× stock solution pH 7.4 (mL)	2 M imidazole pH 7.4 (mL)	Deionized water (mL)
0	6.25	0	to 50 mL
10	6.25	0.25	to 50 mL
20	6.25	0.50	to 50 mL
30	6.25	0.75	to 50 mL
40	6.25	1.00	to 50 mL
50	6.25	1.25	to 50 mL
60	6.25	1.50	to 50 mL
70	6.25	1.75	to 50 mL
80	6.25	2.00	to 50 mL
90	6.25	2.25	to 50 mL
100	6.25	2.50	to 50 mL
150	6.25	3.75	to 50 mL
200	6.25	5.00	to 50 mL
250	6.25	6.25	to 50 mL
300	6.25	7.50	to 50 mL
400	6.25	10.00	to 50 mL
500	6.25	12.50	to 50 mL

### Blank run:


Use binding buffer and elution buffer **without** reducing agents.

1. Wash the column with 5 column volumes of distilled water (to remove the 20% ethanol).
2. Wash with 5 column volumes of elution buffer.
3. Equilibrate with 10 column volumes of binding buffer.


### Standard purification

 When high yield is more important than optimal purity, use the following procedure. When optimal purity is required, use the optimizing procedure (next page) instead.


1. Using the buffer concentrate provided, prepare 24 mL of binding buffer.
2. Using the buffer concentrate provided, prepare 8 mL of elution buffer.
3. Fill the syringe with distilled water. Remove the stopper and connect the column to the syringe with the provided Luer connector “drop to drop” to avoid introducing air into the column. (If air becomes trapped in the column, wash it with distilled water until the air disappears.)
4. Remove the snap-off end. Wash the column with 5 mL of distilled water.
5. Using the syringe, equilibrate the column with 5 to 10 mL of binding buffer.
6. Apply the unclarified lysate with the syringe. Collect the flowthrough fraction. A pump (e.g., Peristaltic Pump P-1) is convenient for large volumes (more than 15 mL) using a maximum flow rate of 3 mL/min.

 Sample loading at 4°C may increase the viscosity of the sample. An adverse effect of increased sample viscosity is that maximum back pressure for the column is reached at a lower sample volume loading on the column. Large volumes may increase back pressure, making the use of a syringe more difficult. Typical loading volumes of unclarified lysate (highly dependent on specific sample, sample pretreatment, and temperature at sample loading): Up to 100 mL.


7. Wash with 10 mL of binding buffer. Collect the wash fraction.
8. Elute with 5 mL of elution buffer. Avoid dilution of the eluate by collecting it in 1 mL fractions.
9. Check the different fractions for the purified protein (e.g., by SDS-PAGE and/or Western blotting). The purified protein is most likely found in the second and third milliliter of the elution step.

 For  $A_{280}$  measurement, use the elution buffer as a blank. If imidazole needs to be removed, use a desalting column (see Chapter 11). Low-quality imidazole will give a significant background absorbance at 280 nm.

10. After elution, regenerate the column by washing it with 10 mL of binding buffer. The column is now ready for a new purification of the same target protein.


 The column does not need to be stripped and recharged between each purification if the same protein is going to be purified. Reuse of any purification column depends on the nature of the sample and should only be performed with identical tagged proteins to prevent cross-contamination. For more information on this topic and on cleaning and storage, refer to Appendix 1.

## Optimizing purification


 When a high purity is needed, the following general procedure for stepwise gradient elution should be used. The next time the same protein is to be purified, the number of steps can be reduced to those described under *Standard purification* with the optimal imidazole concentrations selected here.

1. Prepare binding buffer and five steps of elution buffer ranging from 40 mM to 500 mM imidazole. Check pH of each after mixing and adjust to pH 7.4 to 7.6 if necessary. See Table 3.2.
2. Fill the syringe with distilled water. Remove the stopper and connect the column to the syringe with the provided Luer connector “drop to drop” to avoid introducing air into the column. (If air becomes trapped in the column, wash it with distilled water until the air disappears.)
3. Remove the snap-off end. Wash the column with 5 mL of distilled water.
4. Using the syringe, equilibrate the column with 5 to 10 mL of binding buffer.
5. Apply the unclarified lysate with the syringe. Collect the flowthrough fraction. A pump (e.g., Peristaltic Pump P-1) is convenient for large volumes (more than 15 mL) using a maximum flow rate of 3 mL/min.


*Note: One mL/min corresponds to approximately 30 drops/min when using a syringe with a HiTrap 1 mL column, and 5 mL/min corresponds to approximately 120 drops/min when using a HiTrap 5 mL column.*

 Sample loading at 4°C may increase the viscosity of the sample. An adverse effect of increased sample viscosity is that maximum back pressure for the column is reached at a lower sample volume loading on the column. Large volumes may increase back pressure, making the use of a syringe more difficult. Typical loading volumes of unclarified lysate (highly dependent on specific sample, sample pretreatment, and temperature at sample loading): Up to 100 mL.

6. Wash with 10 mL of binding buffer. Collect the wash fraction.
7. Start elution with 5 mL of the first elution buffer containing 40 mM imidazole. Avoid dilution by collecting the eluate in 1 mL fractions.
8. Proceed with the next imidazole concentration. (For example, elute with 5 mL of elution buffer containing 60 mM imidazole.) Collect the eluate in 1 mL fractions as above.
9. Proceed with the buffers of increasing imidazole concentration, as described in steps 6 and 7. The purified protein is most likely found in the second and third fraction of one of the elution steps.
10. Check the different fractions for the purified protein (e.g., by SDS-PAGE and/or Western blotting).

 For  $A_{280}$  measurements, use the elution buffers as blanks. If imidazole needs to be removed, use a desalting column (see Chapter 11). Low-quality imidazole will give a significant background absorbance at 280 nm.

11. After elution, reequilibrate the column with 10 mL of binding buffer. The column is now ready for a new purification of the same target protein.

 The column does not need to be stripped and recharged between each purification if the same protein is going to be purified. Reuse of any purification column depends on the nature of the sample and should only be performed with identical tagged proteins to prevent cross-contamination. For more information on this topic and on cleaning and storage, refer to Appendix 1.



The results of the above purification provide information about the optimal binding and elution buffers. The optimal elution buffer is the one that eluted the histidine-tagged protein. The optimal binding (wash) buffer is the one from the step before, with a lower concentration of imidazole. Using the highest possible concentration of imidazole in the binding buffer will give the highest purity of the purified protein. Use these buffers for the next purification of an identical protein.

The concentration of imidazole needed to prevent nonspecific binding of host cell proteins (without any elution of histidine-tagged protein) is generally more important to determine than the concentration needed for elution. A concentration of 500 mM can be used for elution in most cases.

**Column:** HisTrap FF crude 1 mL  
**Sample:** MBP-(His)<sub>6</sub>, M<sub>r</sub> 43 000  
**Flow rate:** Approx. 1 mL/min  
**Buffers:** Included in the HisTrap FF crude Kit, prepared according to the instructions  
**Fraction size:** 1 mL  
**Equipment:** Manual purification using a syringe

## Application example

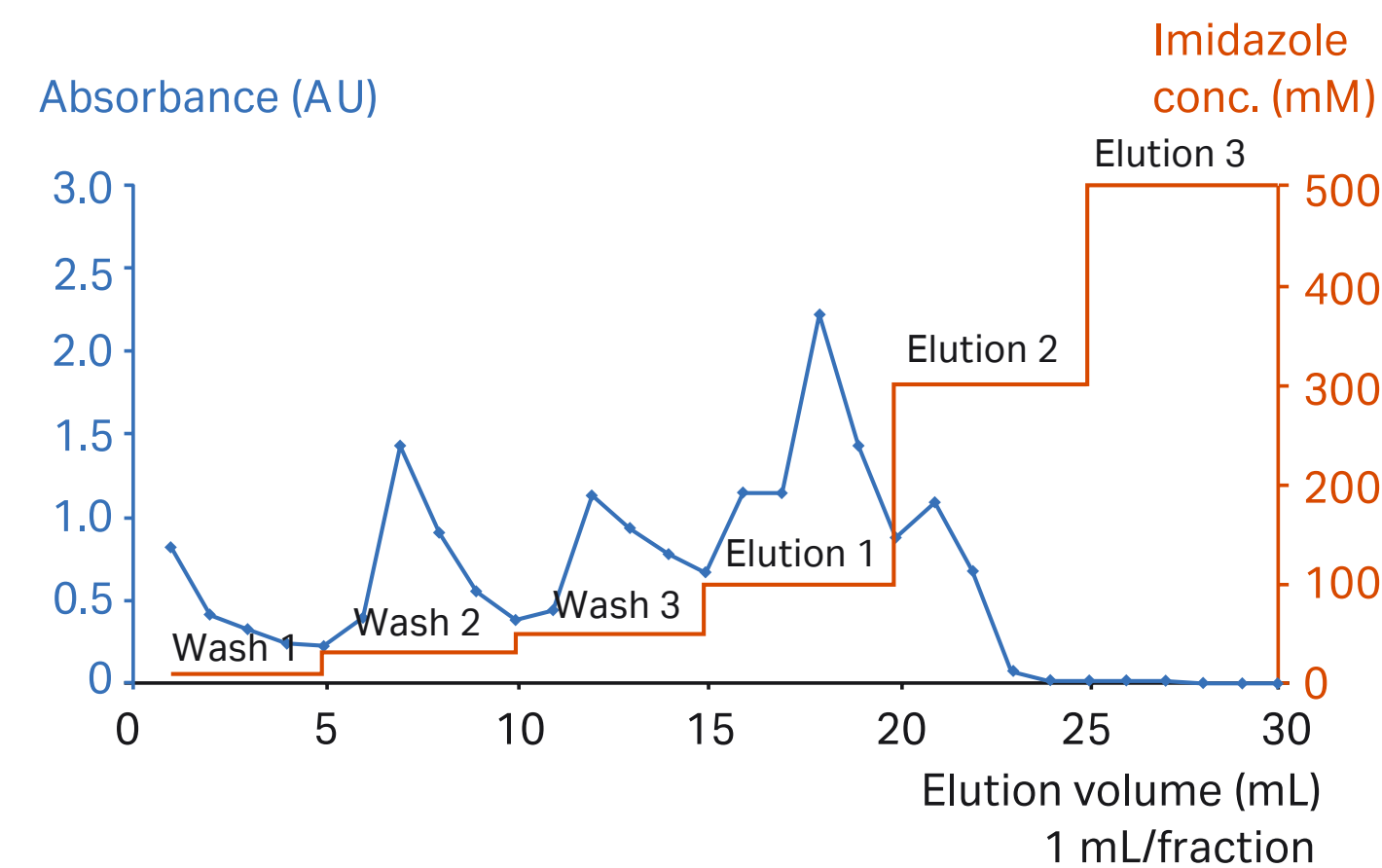
### Purification using HisTrap FF crude Kit

HisTrap FF crude Kit includes three 1 mL HisTrap FF crude columns, ready-made binding and elution buffer concentrates, connectors, a syringe, and instructions. The kit allows purification in a matter of minutes starting from an unclarified cell lysate using the following procedure:

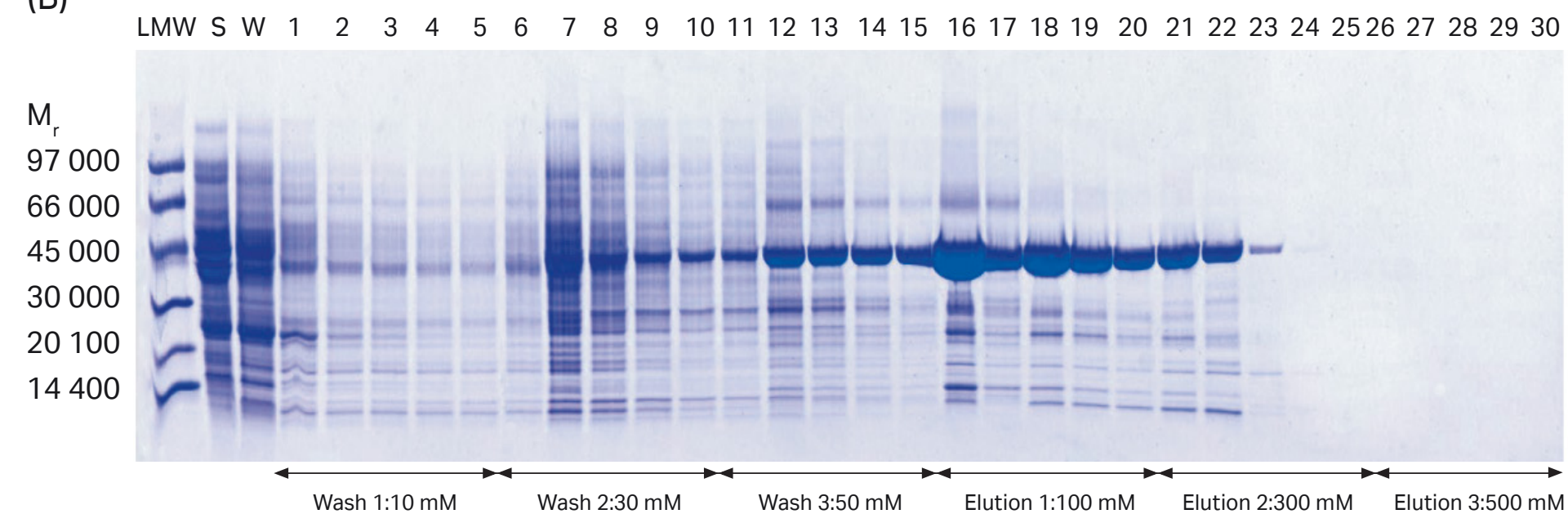
- Lyse cells containing histidine-tagged protein
- Prepare buffers by mixing and diluting the concentrates
- Use the syringe to load unclarified sample to the column, wash, and elute the target protein
- Check purity by SDS-PAGE.

As Figure 3.20 shows, MBP-(His)<sub>6</sub> is effectively purified on the HisTrap FF crude 1 mL column using a syringe and the buffers included in HisTrap FF crude Kit. In this case, 30 mM imidazole was chosen for the wash and 300 mM imidazole for complete elution.

(A)



(B)



#### Lanes

LMW LMW markers  
 S Sample, unclarified, diluted 1:10  
 W Wash 5 mL, 10 mM imidazole

#### Lanes

Fraction 1–5 Wash 1, 10 mM imidazole in buffer  
 Fraction 6–10 Wash 2, 30 mM imidazole in buffer  
 Fraction 11–15 Wash 3, 50 mM imidazole in buffer  
 Fraction 16–20 Elution 1, 100 mM imidazole in buffer  
 Fraction 21–25 Elution 2, 300 mM imidazole in buffer  
 Fraction 26–30 Elution 3, 500 mM imidazole in buffer

**Fig 3.20** (A) Purification of MBP-(His)<sub>6</sub> using HisTrap FF crude Kit. (B) Native SDS-PAGE (ExcelGel 8–18) of 1 mL fractions from the purification.

## Gravity-flow purification using His GraviTrap and His GraviTrap Kit

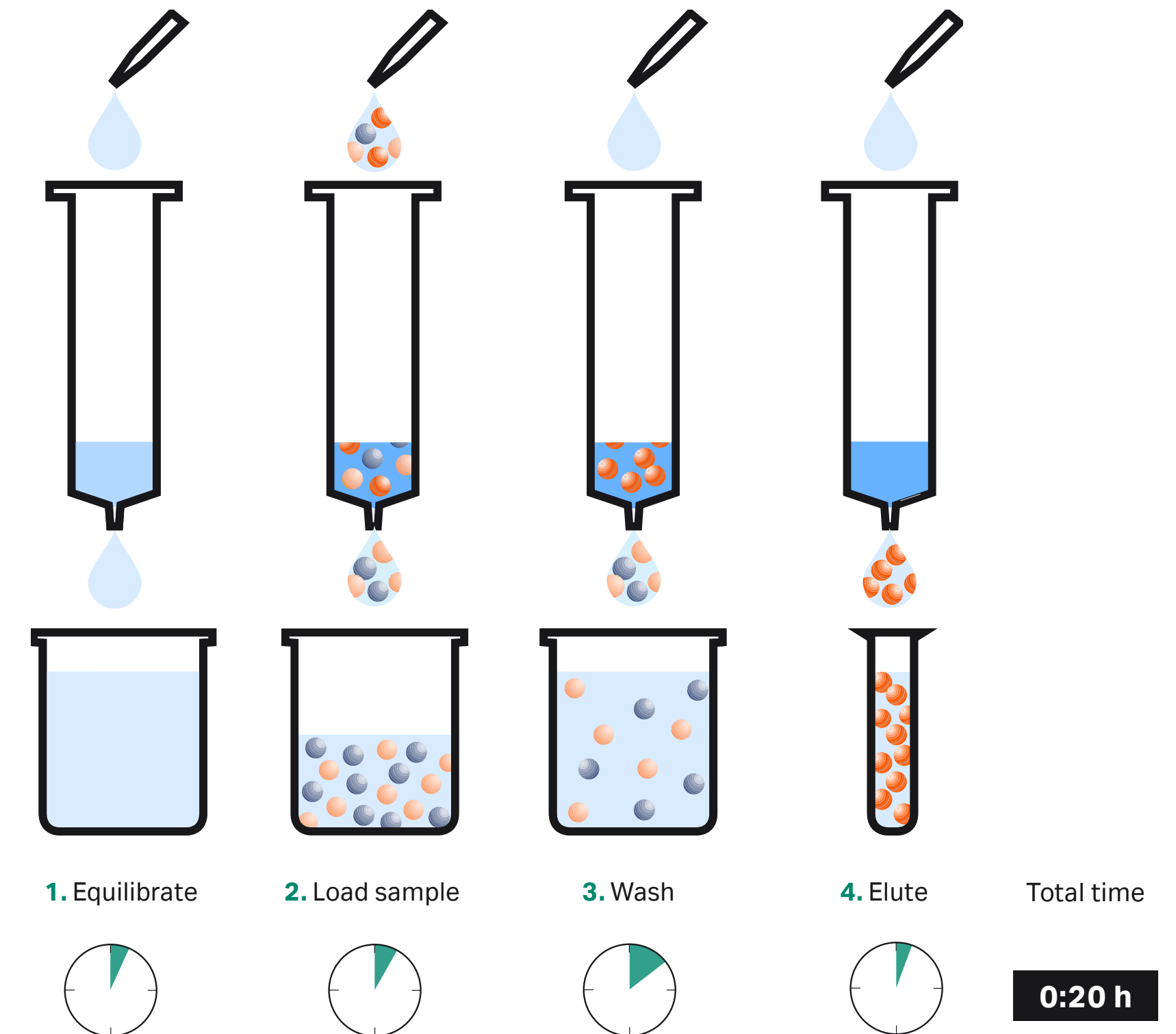
His GraviTrap columns are designed for fast and simple purification of histidine-tagged proteins using gravity flow. Both clarified and unclarified sample can be applied to the column. The column is prepacked with Ni Sepharose 6 Fast Flow. Special column frits protect the chromatography medium from running dry during purification. A typical purification run on His GraviTrap is performed in approximately 20 min (depending on sample volume and viscosity of the solutions).

His GraviTrap columns are delivered in a package that can be converted into a column stand to simplify purification. LabMate PD-10 Buffer Reservoir can be connected to the columns for convenient handling of sample volumes above 10 mL. For optimal performance, use His GraviTrap with buffers prepared from His Buffer Kit.

The benefits of His GraviTrap and His Buffer Kit are combined in His GraviTrap Kit, which contains two packs of His GraviTrap and one pack of His Buffer Kit. His GraviTrap Kit contains columns and buffers for 20 purifications. See Figure 3.22 for a summary of the purification procedure using His GraviTrap.



**Fig 3.21.** His GraviTrap connected to LabMate PD-10 Buffer Reservoir for convenient equilibration, sample application, and wash.





**Fig 3.22.** Purifying histidine-tagged proteins with His GraviTrap is a simple and quick procedure.



## Sample and buffer preparation

Refer to *Purification using Ni Sepharose 6 Fast Flow* earlier in this chapter for a general procedure for sample and buffer preparation.


-  For direct loading of an unclarified sample, it is critical to obtain good cell lysis in order to avoid problems with back pressure. Apply the unclarified lysate on the column directly after preparation.
-  If the sonicated or homogenized unclarified cell lysate is frozen before use, precipitation and aggregation may increase. New sonication of the lysate can then prevent clogging the column.


## Purification


1. Cut off the bottom tip, remove the top cap, pour off excess liquid, and place the column in the Workmate column stand. If needed, mount LabMate (funnel) on top of the column.
2. Equilibrate the column with 10 mL of binding buffer. The frits protect the column from running dry during the run.
3. Add 0.5 to 35 mL of the prepared sample.

-  The protein binding capacity of the column is high (approx. 40 mg histidine-tagged protein/column); however, the value is protein dependent.

4. Wash with 10 mL of binding buffer.
5. Apply 3 mL of elution buffer and collect the eluate. Under denaturing conditions, elute twice with 3 mL of elution buffer.

-  If you use buffers containing denaturing agents or viscous solutions, perform the purification at room temperature.

-  Ni Sepharose is compatible with reducing agents. However, we recommend removal of any weakly bound Ni<sup>2+</sup> ions before applying buffer/sample that includes reducing agents. This can be accomplished by performing a blank run without reducing agents (see below). Do not store His GraviTrap columns with buffers that include reducing agents.

-  Leakage of Ni<sup>2+</sup> from Ni Sepharose is low under all normal conditions. For very critical applications, leakage during purification can be even further diminished by performing a blank run (as described below) before loading sample.

### Blank run:

Use binding buffer and elution buffer **without** reducing agents.

1. Wash the column with 5 column volumes of distilled water (to remove the 20% ethanol).
2. Wash with 5 column volumes of elution buffer.
3. Equilibrate with 10 column volumes of binding buffer.



## Application example

### Rapid purification of a high-molecular-weight histidine-tagged protein using His GraviTrap

His GraviTrap, prepacked with Ni Sepharose 6 Fast Flow, allows quick and simple purification of histidine-tagged proteins without the need for a pump or purification system. A single column allows purification of approximately 40 mg of protein in as little as 20 to 25 minutes. Large volumes of clarified or unclarified samples can easily be applied, and the purified protein can be eluted in a small volume, resulting in a highly concentrated target protein.

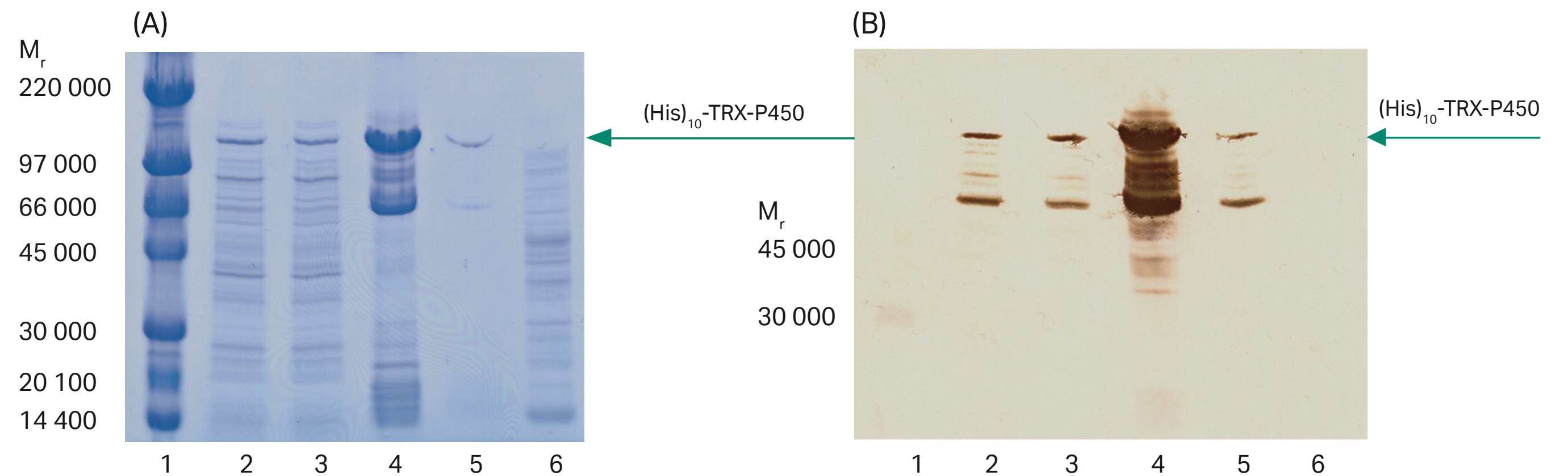
In this example, 20 mL of a clarified *E. coli* JM109 lysate containing (His)<sub>10</sub>-TRX-P450 ( $M_r \sim 130\ 000$ ) was purified in just 25 minutes and analyzed by SDS-PAGE and Western blot (Fig 3.23A and B). SDS-PAGE analysis shows three major protein bands in the eluted fractions. Western blot analysis and N-terminal sequencing (data not shown) confirm that each of the three bands in the eluates contains a histidine tag. The low-molecular-weight bands are truncated forms of the histidine-tagged target protein.

#### Method:

<i>Equilibration:</i>	10 mL binding buffer (including 40 mM imidazole)
<i>Sample application:</i>	20 mL sample (including 40 mM imidazole)
<i>Wash:</i>	2 × 10 mL binding buffer (including 40 mM imidazole)
<i>Elution:</i>	2 × 3 mL elution buffer

#### Western blot:

<i>Electrophoresis and transfer:</i>	PhastSystem™ and PhastGel™ Gradient 10–15
<i>Membrane:</i>	Hybond ECL™
<i>Primary antibody:</i>	Anti-His antibody (mouse)
<i>Secondary antibody:</i>	Anti-mouse IgG, HRP-linked
<i>Detection:</i>	Colorimetric, DAB liquid substrate



**Fig 3.23.** (A) SDS-PAGE and (B) Western blot of (His)<sub>10</sub>-TRX-P450 purified using His GraviTrap column.

#### Lanes

1. High-Range Rainbow™ Molecular Weight Markers
2. Start material (diluted 1:20)
3. Flowthrough (diluted 1:20)
4. Eluate 1
5. Eluate 2
6. Negative control (JM109 nontransformed)

## Condition screening for scaling up using HiScreen Ni FF

HiScreen Ni FF is a ready-to-use column for purification of histidine-tagged recombinant proteins by IMAC. The column has a volume of 4.7 mL of Ni Sepharose 6 Fast Flow and is well suited for screening of selectivity and binding/elution conditions for scaling up, as well as for small-scale purifications. Ni Sepharose 6 Fast Flow has low Ni<sup>2+</sup> leakage and is compatible with a wide range of additives used in protein purification. The columns are made of biocompatible polypropylene that does not interact with biomolecules. See Appendix 1 for the main characteristics of HiScreen Ni FF.

The columns are used in an optimal way with liquid chromatography systems such as ÄKTA.

### Sample and buffer preparation

Refer to *Purification using Ni Sepharose 6 Fast Flow* earlier in this chapter for a general procedure for sample and buffer preparation.

### Purification

The recommended flow rate for HiScreen Ni FF is 2.3 mL/min (300 cm/h flow velocity).

1. Equilibrate with at least 5 column volumes of binding buffer. Avoid introducing air into the column.
2. Adjust the sample to the chosen starting conditions and load on the column.
3. Wash with 5 to 10 column volumes of binding buffer until the UV trace of the effluent returns to near baseline.
4. Elute either by linear gradient elution or step elution at recommended flow rates. If required, the collected eluted fractions can be buffer-exchanged or desalted.
  - Linear gradient elution: Elute with 0% to 100% elution buffer (up to 500 mM imidazole) in 10 to 20 column volumes.
  - Step elution: Elute with 5 column volumes of elution buffer including imidazole at chosen concentration. Repeat at higher imidazole concentrations until the target protein has been eluted.
5. If required, strip the column from metal ions and perform cleaning in place (CIP) to clean the column.
6. Re-equilibrate the column with 5 to 10 column volumes of binding buffer or until the UV baseline, eluent pH, and conductivity reach the required values.



**Fig 3.24.** HiScreen Ni FF column for establishing optimal chromatographic conditions for scaling up.

- 👉 Do not exceed the maximum recommended flow and/or back pressure for the column.
- 👉 For A<sub>280</sub> measurements, use the elution buffers as blanks. If imidazole needs to be removed, use a desalting column (see Chapter 11). Low-quality imidazole will give a significant background absorbance at 280 nm.
- 👉 In some cases, we recommend a blank run before final equilibration/sample application, as described below. Perform a blank run without reducing agents before applying buffers/samples containing reducing agents. Likewise, a blank run is recommended for critical purifications where metal ion leakage during purification must be minimized.

#### Blank run:

Use binding buffer and elution buffer **without** reducing agents.

1. Wash the column with 5 column volumes of distilled water (to remove the 20% ethanol).
2. Wash with 5 column volumes of elution buffer.
3. Equilibrate with 10 column volumes of binding buffer.



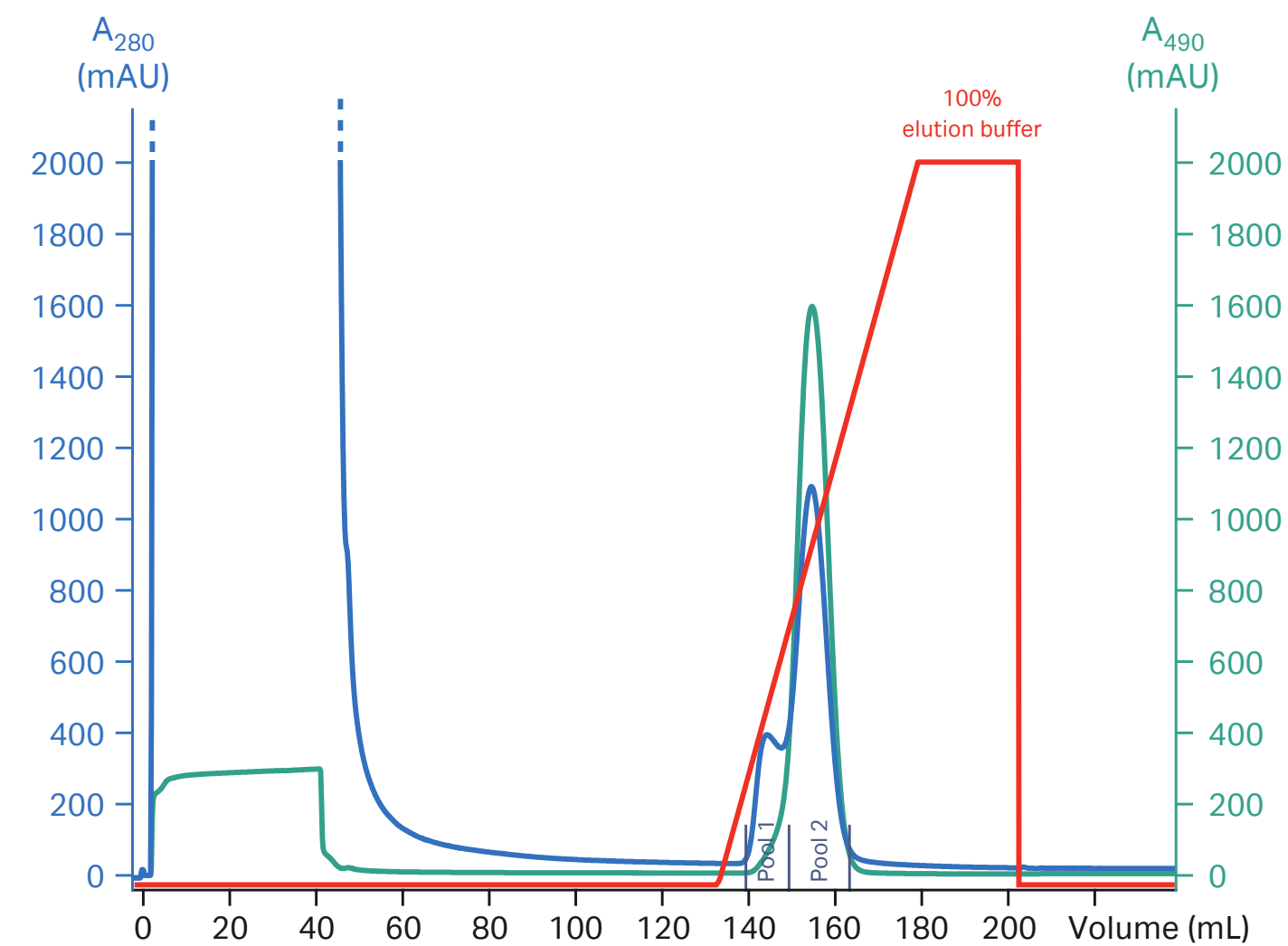
## Application example

### Purification of GFP-(His)<sub>6</sub> expressed in *E. coli*

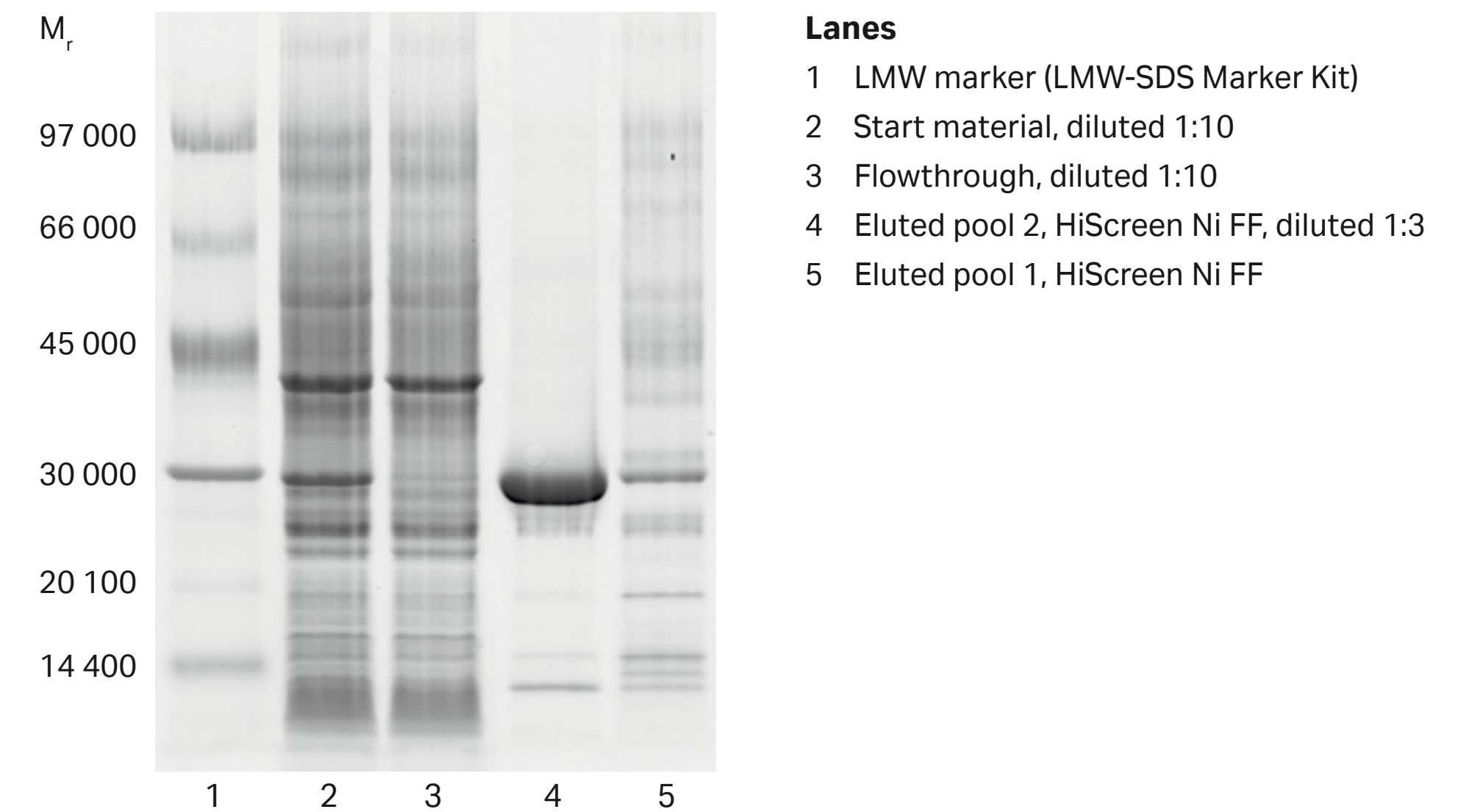
HiScreen Ni FF was used for purification of histidine-tagged green fluorescent protein, GFP-(His)<sub>6</sub>, expressed in *E. coli*. The elution was performed using a 10 column volume linear gradient with imidazole up to 500 mM. Two partly resolved peaks were obtained; absorbance measurement at the specific wavelength 490 nm indicated the presence of GFP-(His)<sub>6</sub> in the second peak (Fig 3.25).

This finding was confirmed by SDS-PAGE analysis: the second pool contained highly pure GFP-(His)<sub>6</sub>, > 95% whereas the first peak, Pool 1, contained primarily contaminants (Fig 3.26). The amount of GFP-(His)<sub>6</sub> in the second pool was 42 mg as determined by measurement of absorbance at 490 nm.

Column:	HiScreen Ni FF
Sample:	40 mL GFP-(His) <sub>6</sub> in <i>E. coli</i> lysate
Start and wash buffer:	20 mM sodium phosphate, 500 mM NaCl, 20 mM imidazole, pH 7.4
Elution buffer:	20 mM sodium phosphate, 500 mM NaCl, 500 mM imidazole, pH 7.4
Flow rate:	300 cm/h (2.3 mL/min)
Linear gradient:	0% to 100% elution buffer in 10 CV
System:	ÄKTA avant 25



**Fig 3.25.** Purification of GFP-(His)<sub>6</sub> expressed in *E. coli* BL21 on HiScreen Ni FF. Indicated pools were analyzed by SDS-PAGE (Fig 3.26).



**Fig 3.26.** SDS-PAGE analysis (reducing conditions) of GFP-(His)<sub>6</sub> after purification on HiScreen Ni FF. ExcelGel SDS Gradient 8-18.



## Preparative purification using HisPrep FF 16/10

HisPrep FF 16/10 columns are specially designed 20 mL HiPrep™ columns, ready to use for easy, one-step preparative purification of histidine-tagged proteins. Packed with Ni Sepharose 6 Fast Flow, the columns exhibit high binding capacity and excellent flow properties. For easy scale-up, columns can be connected in series (back pressure will increase).

The column is made of polypropylene, which is biocompatible and noninteractive with biomolecules. Purifications can be easily achieved using a chromatography system such as ÄKTA or other chromatography systems. Refer to Chapter 2, Table 2.1 for a selection guide to purification equipment and to Appendix 1 for a list of HisPrep FF 16/10 column parameters. Note that HisPrep FF 16/10 columns cannot be opened or refilled.

### Sample and buffer preparation

Refer to *Purification using Ni Sepharose 6 Fast Flow* earlier in this chapter for a general procedure for sample and buffer preparation.

### Purification

For first-time use, it is important to set an appropriate pressure limit on the system (maximum pressure over the packed bed is 1.5 bar).

1. Equilibrate with at least 5 column volumes of binding buffer. Avoid introducing air into the column.
2. Apply the centrifuged and/or filtered sample (in binding buffer) to the column at a flow rate of 1 to 10 mL/min (30 to 300 cm/h).
3. Wash the column with 5 to 10 column volumes of binding buffer at 2 to 10 mL/min (60 to 300 cm/h).
4. Elute the bound protein with 5 to 10 column volumes of elution buffer at a flow rate of 2 to 10 mL/min (60 to 300 cm/h).
5. After elution, regenerate the column by washing it with approximately 100 mL of binding buffer. The column is now ready for a new purification of the same target protein.

☞ The column does not need to be stripped and recharged between each purification if the same protein is going to be purified. Reuse of any purification column depends on the nature of the sample and should only be performed with identical tagged proteins to prevent cross-contamination. For more information on this topic and on cleaning and storage, refer to Appendix 1.



**Fig 3.27.** HisPrep FF 16/10 column for convenient preparative purification of histidine-tagged proteins.

- ☞ Ni Sepharose 6 Fast Flow is compatible with reducing agents. However, we recommend removal of any weakly bound Ni<sup>2+</sup> ions before applying buffer/sample that includes reducing agents. This can be accomplished by performing a blank run without reducing agents (see below). Do not store HisPrep columns with buffers that include reducing agents.
- ☞ Leakage of Ni<sup>2+</sup> from Ni Sepharose 6 Fast Flow is low under all normal conditions. For very critical applications, leakage during purification can be even further diminished by performing a blank run (as described below) before loading sample.
- ☞ For A<sub>280</sub> measurements, use the elution buffers as blanks. If imidazole needs to be removed, use a desalting column (see Chapter 11). Low-quality imidazole will give a significant background absorbance at 280 nm.

### Blank run:

Use binding buffer and elution buffer **without** reducing agents.

1. Wash the column with 5 column volumes of distilled water (to remove the 20% ethanol).
2. Wash with 5 column volumes of elution buffer.
3. Equilibrate with 10 column volumes of binding buffer.

### Application example

Refer to Figure 3.13.

## Magnetic bead-based purification/screening using His Mag Sepharose Ni

His Mag Sepharose Ni is a magnetic-bead-based IMAC medium charged with nickel ions. It is designed for efficient, small-scale purification/screening of histidine-tagged proteins from various sources. Histidine-tagged proteins are captured using immobilized nickel ions followed by collection of the beads using a magnetic device. For purification of histidine-tagged proteins secreted into eukaryotic cell culture medium it is recommended to use His Mag Sepharose excel.

A vial containing 1 mL of 5% medium slurry is sufficient for five purification runs according to the recommended protocol. Together with MagRack 6, a separation tool for handling the beads in microcentrifuge tubes, up to six samples can be processed in parallel. A larger magnetic rack, MagRack Maxi, can be used for capture of low-expressed histidine-tagged proteins in sample volumes up to 50 mL. For screening of a larger number of samples in parallel with high throughput, a robotic device can be used.



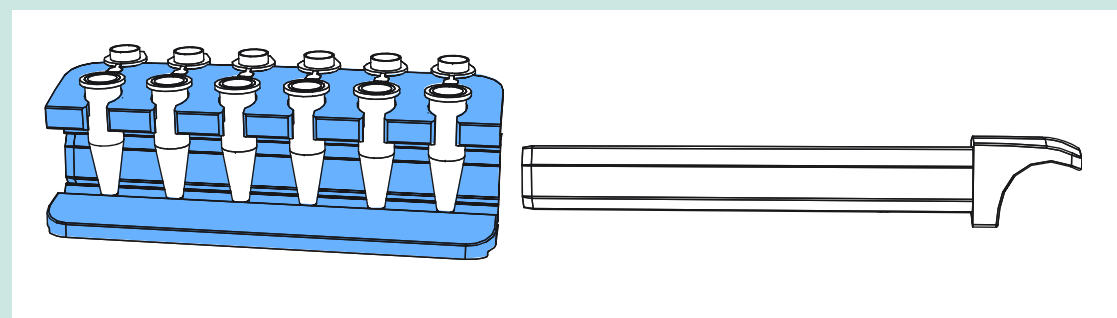
**Fig 3.28.** His Mag Sepharose Ni for small-scale purification/screening. His Mag Sepharose Ni is available as a 5% medium slurry in 2 × 1 mL, 5 × 1 mL, and 10 × 1 mL pack sizes.



## General magnetic separation steps

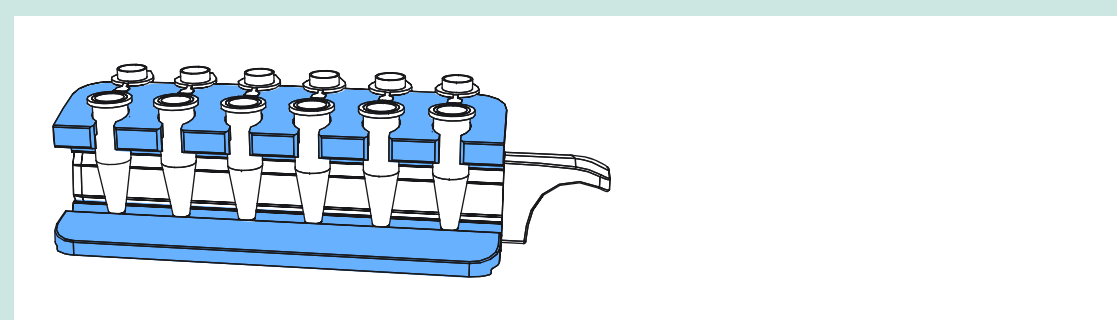
When performing magnetic separation, it is recommended to use MagRack 6 for test tubes up to 1.5 mL and MagRack Maxi for test tubes up to 50 mL.

1. Remove the magnet before adding liquid.



2. Insert the magnet before removing liquid.

When using volumes above 50 mL, the beads can be spun down using a swing-out centrifuge.



## Dispensing the medium slurry

1. Prior to dispensing the medium slurry, make sure it is homogeneous by vortexing the vial thoroughly.
2. When the medium slurry is resuspended, immediately pipette the required amount of medium slurry into the desired tube.
3. Due to the fast sedimentation of the beads, it is important to repeat the resuspension between each pipetting.

## Handling liquids

1. Before application of liquid, remove the magnet from the magnetic rack.
2. After addition of liquid, resuspend the beads by vortexing or manual inversion of the tube. When processing multiple samples, manual inversion of the magnetic rack is recommended.
3. Use the magnetic rack with the magnet in place for each liquid removal step. Pipette or pour off the liquid. If needed, a pipette can be used to remove liquid from the lid of the test tube.

## Incubation

During incubation, make sure the magnetic beads are well resuspended and kept in solution by end-over-end mixing or by using a benchtop shaker.

- 👉 Incubation generally takes place at room temperature. However, incubation can take place at 4°C if this is the recommended condition for the specific sample.
- 👉 When purifying samples of large volumes, an increase of the incubation time may be necessary.

## Sample and buffer preparation

Refer to *Purification using Ni Sepharose 6 Fast Flow* earlier in this chapter for a general procedure for sample and buffer preparation.

- 👉 Suitable buffers can be easily prepared using His Buffer Kit (see *Ordering information*).
- 👉 Insufficient lysis may require clarification of sample before applying it to the beads.



## Purification

### Magnetic bead preparation

1. Mix the bead slurry thoroughly by vortexing. Dispense 200  $\mu\text{L}$  of homogeneous slurry into a 1.5 mL test tube.
2. Place the test tube in the magnetic rack.
3. Remove the storage solution.

### Equilibration

4. Add 500  $\mu\text{L}$  of binding buffer.
5. Resuspend the beads.
6. Remove the liquid.

### Sample application

7. Immediately after equilibration, add 1000  $\mu\text{L}$  of sample. If the sample volume is less than 1000  $\mu\text{L}$ , dilute to 1000  $\mu\text{L}$  with binding buffer.
8. Resuspend the medium and incubate for 30 min with slow end-over-end mixing or by using a benchtop shaker.
9. Remove the liquid.

### Washing (perform this step 3 times in total)

10. Add 500  $\mu\text{L}$  of binding buffer.
11. Resuspend the beads.
12. Remove the liquid.

### Elution

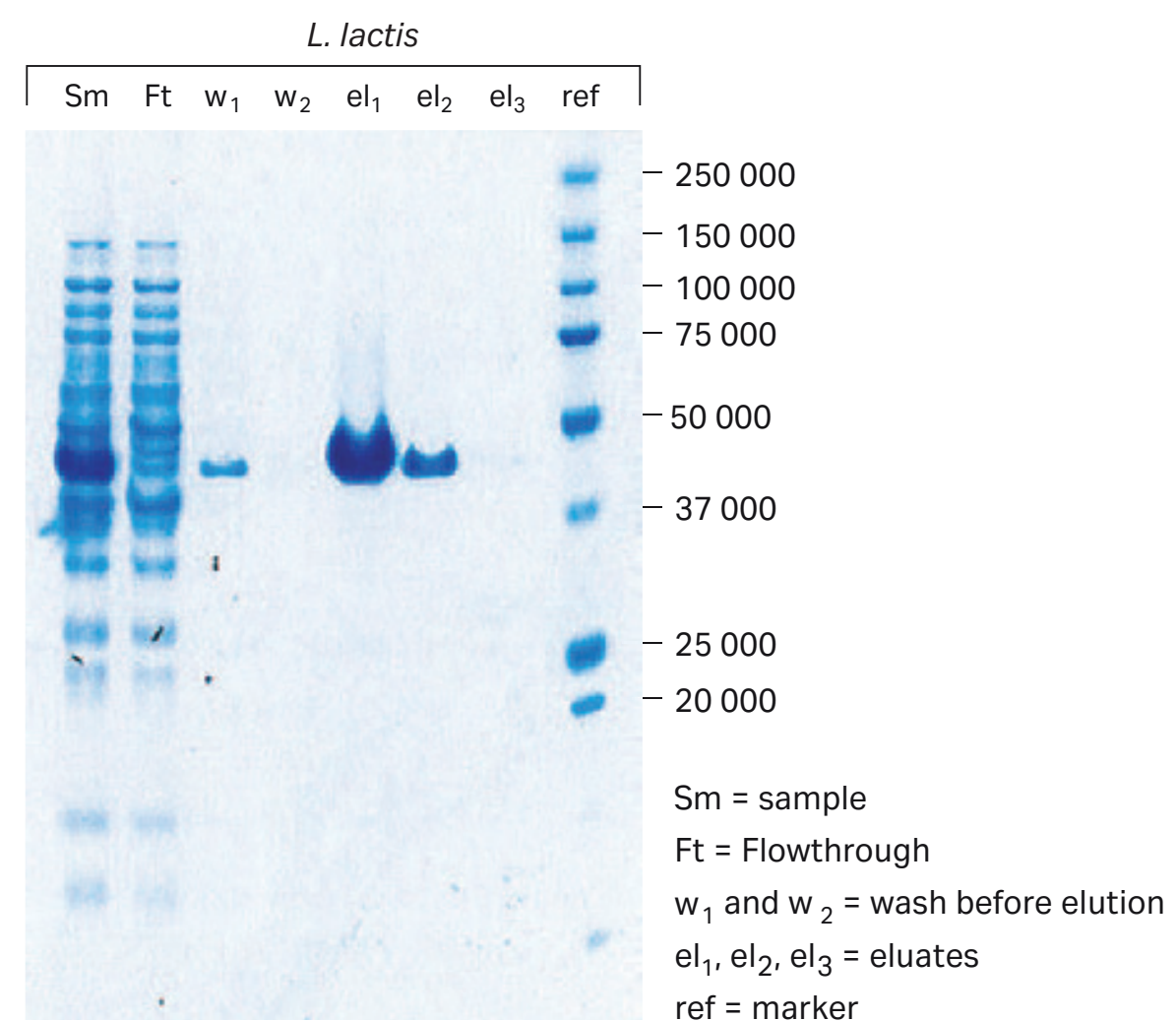
13. Add 100  $\mu\text{L}$  of elution buffer.
14. Resuspend the beads.
15. Remove and collect the elution fraction. The collected elution fraction contains the main part of the purified protein. If desired, repeat the elution.

## Application example

### Purification of a cell-wall-associated protein in *Lactococcus lactis*

A histidine-tagged cell-wall-associated protein from *Staphylococcus aureus* was expressed in *Lactococcus lactis* and purified using His Mag Sepharose Ni. The primary goal was to obtain high purity, therefore 50 mM imidazole was included in the sample and binding buffer. The SDS-polyacrylamide gel shows a minor leakage of target protein during sample application and wash, as a result of the relatively high imidazole concentration. The purity of the eluted target protein was above 95%, and the yield was approximately 600 µg of purified protein (Fig 3.29).

**Sample:** Histidine-tagged protein Y in *L. lactis*  
**Sample volume:** 1 mL  
**Binding/wash buffer:** 20 mM sodium phosphate, 0.5 M NaCl, and 50 mM imidazole, pH 7.4  
**Elution buffer:** 20 mM sodium phosphate, 0.5 M NaCl, and 500 mM imidazole, pH 7.4

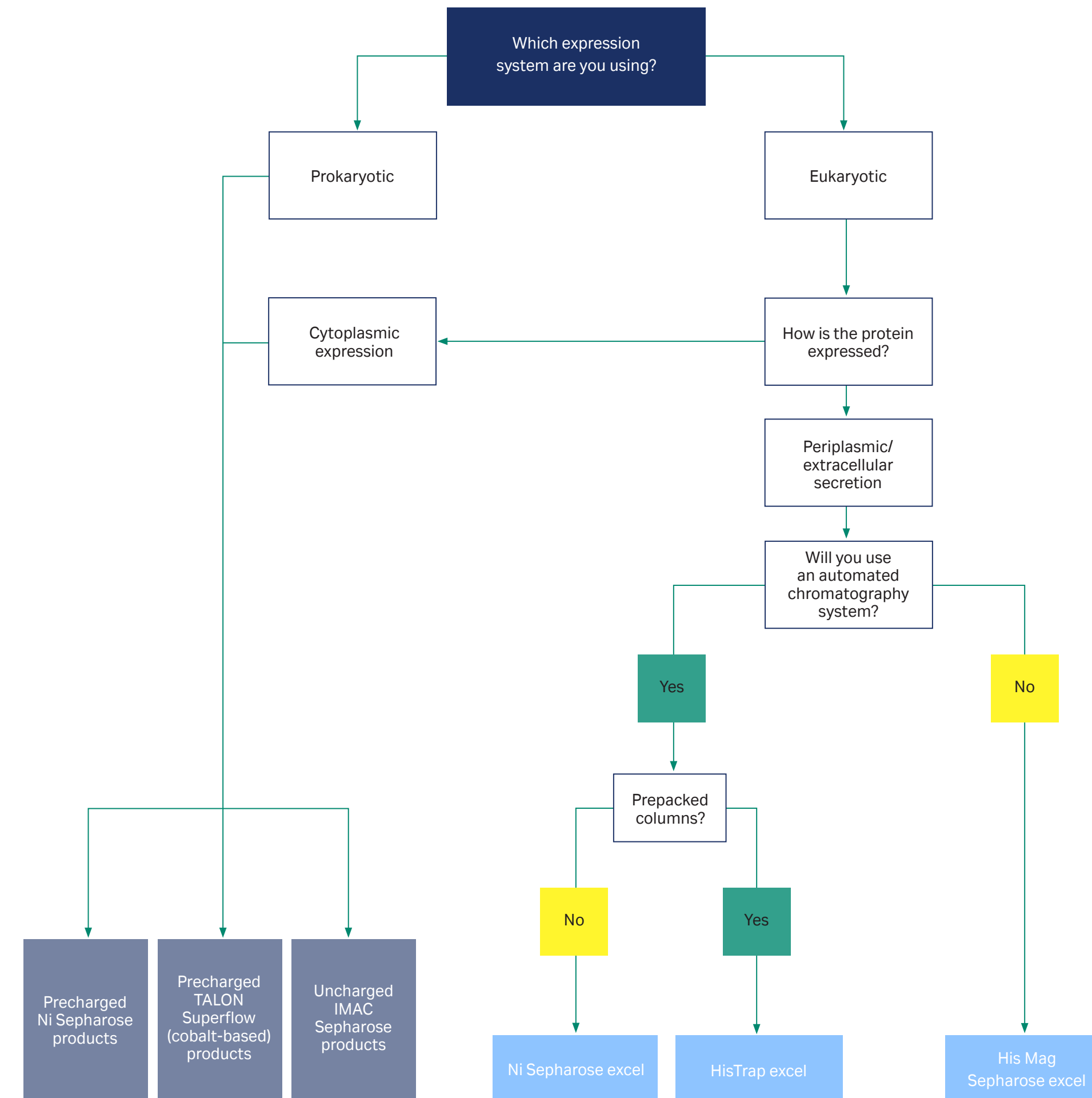


**Fig 3.29.** Purification of a cell wall protein in *L. lactis* resulted in high purity (> 95%) according to SDS-polyacrylamide gel stained with Coomassie.

**Acknowledgement:** The results for histidine-tagged protein purification in *L. Lactis* were kindly provided by Prof. Jan-Maarten van Dijk and Dennis Koedijk, University Medical Centre of Groningen (UMCG), Groningen, The Netherlands.

## Purification using Ni Sepharose excel products

Figure 3.30 provides a selection guide for the Ni Sepharose excel products. The medium is designed for purification of histidine-tagged proteins secreted into eukaryotic cell culture supernatants, such as from insect cells or CHO cells. Ni Sepharose excel is also suitable for purification of proteins from other samples that cause nickel stripping.



**Fig 3.30.** Selection guide for Ni Sepharose excel products. TALON Superflow and uncharged IMAC Sepharose products are discussed later in this chapter.

## Purification of histidine-tagged proteins secreted into eukaryotic cell culture supernatants using Ni Sepharose excel

Ni Sepharose excel consists of 90 µm highly cross-linked agarose beads, to which a chelating ligand has been coupled. The ligand is precharged with nickel ions that are exceptionally strongly bound, thus enabling direct loading of samples that usually cause stripping of nickel from conventional IMAC media. For example, the nickel ions remain bound even after 24 h of incubation in 10 mM EDTA.

Extensive and time-consuming sample pretreatment procedures, for example, buffer exchange by dialysis in combination with concentration procedures, can be avoided. Examples of samples that often cause stripping problems are cell culture supernatants containing secreted histidine-tagged proteins from eukaryotic cells, such as insect cells or CHO cells.

The flow properties of Ni Sepharose excel make it excellent for purifications in all scales and allow loading of large sample volumes. Due to low target protein concentrations, several liters of sample often need to be processed when purifying secreted proteins.

See Appendix 1 for the main characteristics of Ni Sepharose excel.

### Column packing

Ni Sepharose excel is supplied preswollen in 20% ethanol. Suitable columns for packing are Tricorn™, XK, and HiScale™ columns; see *Ordering information*. The column packing procedure differs from the general procedure for other chromatography media as described in Appendix 6. Follow this recommended packing procedure below for Ni Sepharose excel.

1. Allow the medium slurry to sediment for 3 h.
2. Add enough 20% ethanol to achieve a 1:1 ratio of settled medium and overlaid 20% ethanol.
3. Assemble the column (and packing reservoir if necessary).

 If the purification is to be performed at a high flow rate, HiScale columns are recommended.

4. Remove air from the end-piece and adapter by flushing with 20% ethanol.

 Make sure no air has been trapped under the column bed support.



**Fig 3.31.** Ni Sepharose excel for purification of histidine-tagged proteins secreted into eukaryotic cell culture supernatants; it is available in 25 mL, 100 mL, and 500 mL volumes.

5. Close the column outlet leaving the bed support covered with 20% ethanol.
6. Resuspend the medium and pour the slurry into the column in a single continuous motion. Pouring the slurry down a glass rod held against the column wall will minimize the introduction of air bubbles.
7. Allow the medium slurry to sediment for at least 3 h.
8. If using a packing reservoir, disconnect the reservoir and fill the remainder of the column with 20% ethanol.
9. Mount the adapter and connect the column to a pump.



 Avoid trapping air bubbles under the adapter or in the inlet tubing.



10. Immediately open the bottom outlet of the column and set the pump to run at the desired flow rate<sup>1</sup>.
11. Maintain packing flow rate for at least 3 column volumes after a constant bed height is reached.
12. Stop the pump and close the column outlet.
13. With the adapter inlet disconnected, quickly push the adapter down into the column until it reaches the bed surface and then a further 3 to 4 mm into the medium bed. Lock the adapter at this level.
14. Connect the column to a pump or a chromatography system and start equilibration. Readjust the adapter if necessary.




<sup>1</sup> Should be at least 133% of the flow rate to be used during subsequent chromatographic procedures. If this cannot be obtained, use the maximum flow rate your pump can deliver. This should also give a well-packed bed.

## Sample preparation

-  Before sample loading, whole cells must be removed by, for example, centrifugation, otherwise clogging of the column may occur. When using HisTrap excel columns, no further clarification is needed. When using Ni Sepharose excel packed in other columns, it is recommended to also filter the sample through a 0.45 µm filter to remove cell debris and/or other particulate material.
-  Adjust the sample to the composition and pH of the binding buffer by adding buffer and NaCl from concentrated stock solutions or by diluting with binding buffer. For optimal binding, it is **not** recommended to include imidazole in sample and binding buffer. It is recommended to perform binding at neutral pH. However, successful purification has routinely been observed with binding performed at a pH as low as 6.0. Due to the precipitation risk, avoid using strong bases or acids for pH adjustments.



## Buffer preparation

Binding buffer:	20 mM sodium phosphate, 0.5 M NaCl, pH 7.4
Wash buffer:	20 mM sodium phosphate, 0.5 M NaCl, 0 to 30 mM imidazole, pH 7.4
Elution buffer:	20 mM sodium phosphate, 0.5 M NaCl, 500 mM imidazole, pH 7.4

-  Water and chemicals used for buffer preparation should be of high purity. Filter buffers through a 0.45 µm filter before use. Use high purity imidazole, which gives essentially no absorbance at 280 nm.
-  It is not recommended to include imidazole in sample and binding buffers.
-  Optimal imidazole concentration during wash is sample dependent. See Chapter 4 for further information.

## Purification

1. If the column contains 20% ethanol, wash it with 5 column volumes of distilled water. Use a flow velocity of 50 to 100 cm/h. Refer to Appendix 8 for flow rate calculations.
2. Equilibrate the column with at least 5 column volumes of binding buffer at a flow velocity of 150 to 600 cm/h.
3. Load the sample at a flow velocity of 150 to 600 cm/h.
4. Wash with 20 column volumes of wash buffer at a flow velocity of 150 cm/h.
5. Elute with elution buffer using a one-step procedure. Five column volumes of elution buffer is usually sufficient. Alternatively, a linear elution gradient (10 to 20 column volumes) may give higher purity, at the expense of lower target protein concentration in eluted fractions. Use a flow velocity of 150 cm/h.

-  Purification at low temperatures increases the sample and buffer viscosity, leading to increased back pressure. If necessary, decrease flow rate.
-  For A<sub>280</sub> measurements, use the elution buffers as blanks. If imidazole needs to be removed, use a desalting column (see Chapter 11). Low-quality imidazole will give a significant background absorbance at 280 nm.

## Purification of histidine-tagged proteins secreted into eukaryotic cell culture supernatants using HisTrap excel

HisTrap excel 1 mL and 5 mL columns are ready-to-use IMAC columns prepacked with Ni Sepharose excel. The design of the columns in combination with the specific properties of the medium enables fast and convenient purification of histidine-tagged proteins secreted into eukaryotic cell culture supernatant. The special type of filters in the top and bottom of the columns makes it possible to directly load cell-free, unclarified samples on the columns without causing back-pressure problems. This feature saves time, which helps to prevent degradation and thus loss of sensitive target proteins.

HisTrap excel columns are made of biocompatible polypropylene that does not interact with biomolecules. The columns are delivered with a stopper on the inlet and a snap-off end on the outlet. HisTrap excel columns cannot be opened or refilled.

The columns can be operated with either a peristaltic pump or chromatography systems such as ÄKTA systems. For easy scaling up, two HisTrap excel columns can simply be connected in series.

See Appendix 1 for the main characteristics of HisTrap excel.



**Fig 3.32.** HisTrap excel allows direct purification of cell-free, unclarified samples; it is available as 1 mL and 5 mL prepacked columns.





## Sample and buffer preparation

Refer to *Purification of histidine-tagged proteins secreted into eukaryotic cell culture supernatants using Ni Sepharose excel* earlier in this chapter for a general procedure for sample and buffer preparation.

## Purification

1. Fill the pump tubing with distilled water. Remove the stopper and connect the column to the chromatography system or the laboratory pump "drop-to-drop" to avoid introducing air into the column. Make sure that the connector is tight to prevent leakage.
2. Remove the snap-off end at the column outlet.
3. Wash out the ethanol with 5 column volumes of distilled water at a flow rate of 1 mL/min.
4. Equilibrate the column with at least 5 column volumes of binding buffer. Recommended flow rates are 1 to 4 mL/min (1 mL column) and 5 to 20 mL/min (5 mL column).
5. Load the sample. For best results, use a flow rate of 1 to 4 mL/min (1 mL column) or 5 to 20 mL/min (5 mL column) during sample application.
6. Wash with 20 column volumes of wash buffer. Maintain a flow rate of 1 mL/min (1 mL column) or 5 mL/min (5 mL column) for washing.
7. Elute with elution buffer using a one-step procedure. Five column volumes of elution buffer is usually sufficient. Alternatively, a linear elution gradient (10 to 20 column volumes) may give higher purity, at the expense of lower target protein concentration. Maintain a flow rate of 1 mL/min (1 mL column) or 5 mL/min (5 mL column) for elution.

 Purification at low temperatures increases the sample and buffer viscosity, leading to increased back pressure. If necessary, decrease the flow rate.

 For  $A_{280}$  measurements, use the elution buffers as blanks. If imidazole needs to be removed, use a desalting column (see Chapter 11). Low-quality imidazole will give a significant background absorbance at 280 nm.



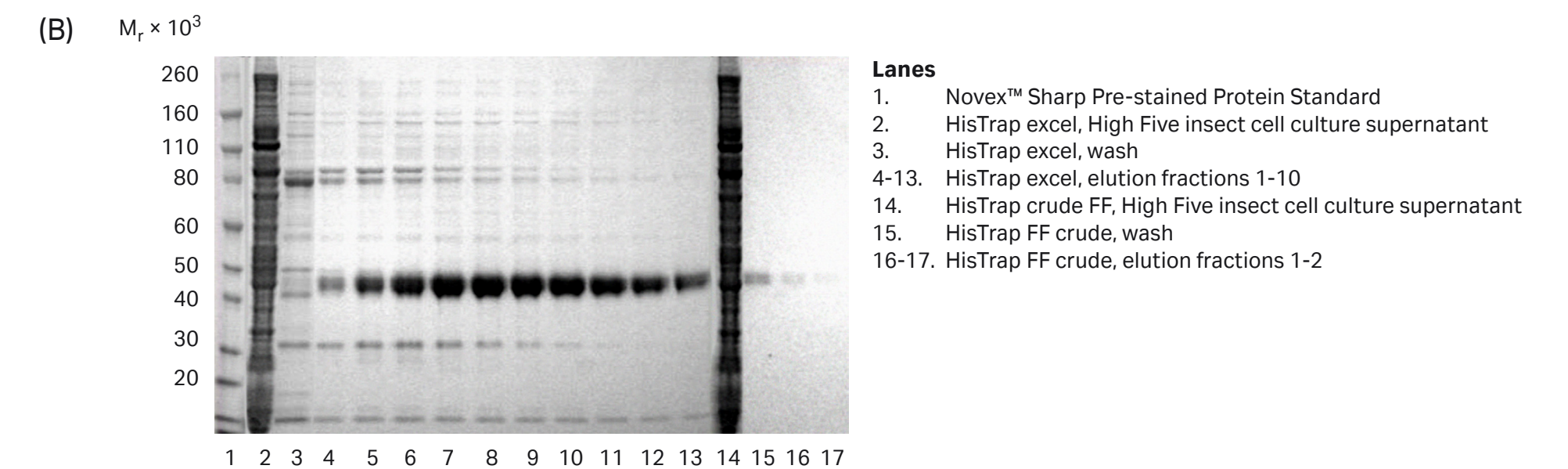
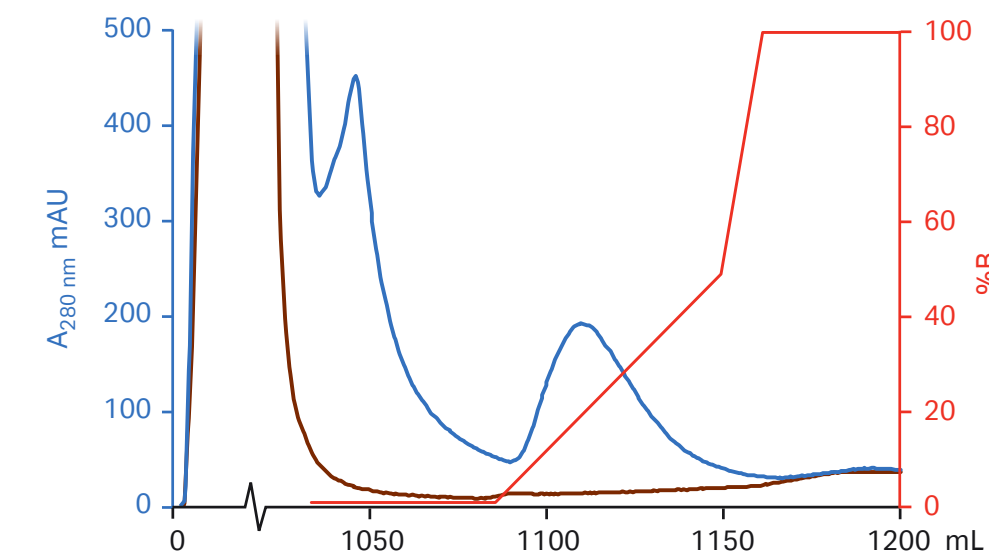
## Application example

### Purification of protein secreted into insect cell culture medium

In this example, purifications of a protein secreted into insect cell culture medium were compared as follows: A histidine-tagged truncated hemagglutinin ((his)<sub>6</sub>-HA) expressed in High Five™ insect cells and secreted into insect cell culture medium was applied onto HisTrap excel 5 mL and HisTrap FF crude 5 mL columns (the latter prepacked with Ni Sepharose 6 Fast Flow).

Figure 3.33 illustrates the difference in performance between HisTrap excel and HisTrap FF crude. Total protein yield eluted from the HisTrap excel column was estimated to be 12.7 mg, comprising approximately 8.9 mg of the protein of interest, whereas the amount of protein eluted from HisTrap FF crude was too low to be quantitated. In addition, HisTrap excel retained its blue color after purification whereas HisTrap FF crude did not, further demonstrating that HisTrap excel resists nickel ion stripping. This comparative study clearly demonstrates the advantages of using HisTrap excel when isolating histidine-tagged proteins from a cell culture medium that causes metal ion stripping.

- (A) *Column:* HisTrap excel 5 mL and HisTrap FF crude 5 mL  
*Sample:* (his)<sub>6</sub>-HA secreted into GIBCO™ Sf-900 II SFM insect cell culture medium, pH 6.6. No imidazole added.  
*Sample volume:* 1020 mL and 1012 mL, respectively  
*Equilibration/wash buffer:* 20 mM sodium phosphate, 500 mM NaCl, 20 mM imidazole, pH 7.4  
*Elution buffer:* 20 mM sodium phosphate, 500 mM NaCl, 500 mM imidazole, pH 7.4  
*Flow rate:* 5 mL/min  
*Temperature:* Room temperature  
*System:* ÄKTA



**Fig 3.33.** (A) Comparative purification of (his)<sub>6</sub>-HA in insect cell culture supernatant using HisTrap excel (blue) and HisTrap FF crude (brown); (B) SDS-PAGE analysis of elution fractions from the same purifications. The SDS-PAGE gel (reducing conditions) was stained with SimplyBlue™ SafeStain and analyzed with Gel Doc™ XR+ System. We would like to thank Dr. Linda Lua and members of UQ Protein Expression Facility, the University of Queensland, Brisbane, Australia, for performing the application work on (his)<sub>6</sub>-HA.



## Magnetic bead-based purification of histidine-tagged proteins secreted into eukaryotic cell culture supernatants using His Mag Sepharose excel

His Mag Sepharose excel is a magnetic-bead-based IMAC medium charged with nickel ions. The magnetic beads are designed for simple, small-scale capture and purification of histidine-tagged proteins secreted into eukaryotic cell culture supernatants. With nickel ions exceptionally strongly bound to a chelating ligand, His Mag Sepharose excel is optimal for samples that usually cause stripping of metal ions from conventional IMAC media. For samples without extensive stripping effects, it is recommended to use His Mag Sepharose Ni, which normally shows higher affinity for histidine-tagged proteins. His Mag Sepharose excel may be used for purification of a single sample or multiple samples in parallel, for example, in screening experiments.

One mL of 10% (v/v) medium slurry contains 100  $\mu$ L of magnetic beads, which is sufficient for five reactions according to the recommended protocol.

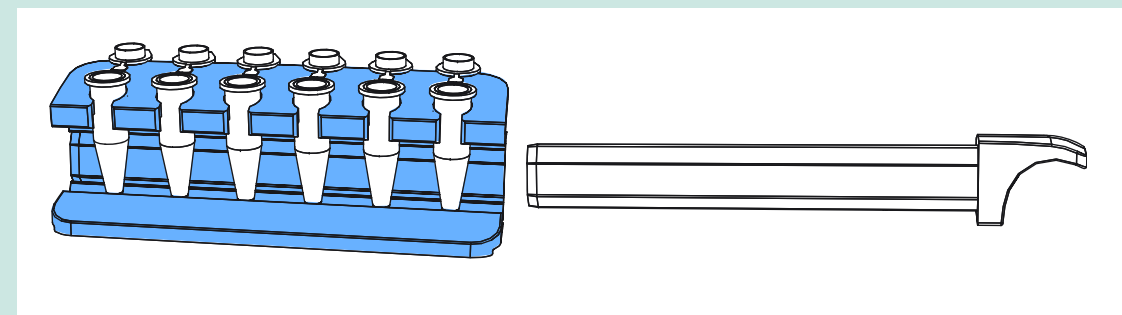
His Mag Sepharose excel can be used together with different test tubes and magnetic racks, for example MagRack 6 for sample volumes up to 1.5 mL or MagRack Maxi for sample volumes up to 50 mL. His Buffer Kit can be used to facilitate buffer preparation.

See Appendix 1 for the main characteristics of His Mag Sepharose excel.

### General magnetic separation steps

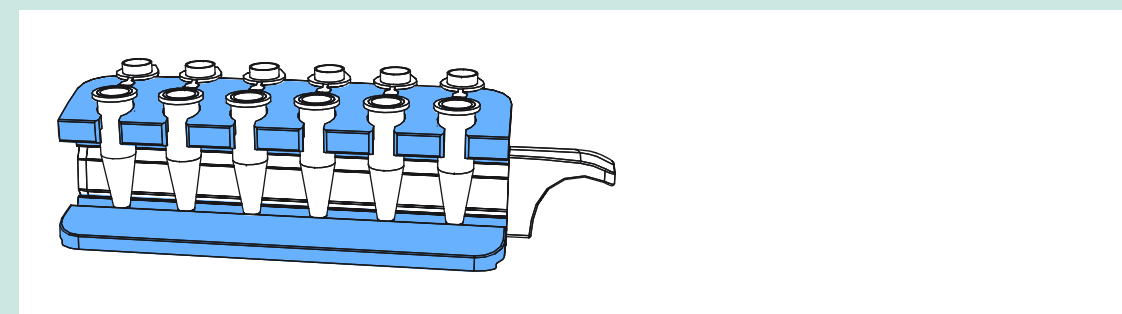
When performing magnetic separation, it is recommended to use MagRack 6 for test tubes up to 1.5 mL and MagRack Maxi for test tubes up to 50 mL.

1. Remove the magnet before adding liquid.



2. Insert the magnet before removing liquid.

When using volumes above 50 mL, the beads can be spun down using a swing-out centrifuge.



**Fig 3.34.** His Mag Sepharose excel increases target protein yield and decreases degradation through reduced and simplified sample handling for small-scale purification/screening. It is available as a 10% medium slurry in 2  $\times$  1 mL, 5  $\times$  1 mL, and 10  $\times$  1 mL pack sizes.

## Dispensing the medium slurry

1. Prior to dispensing the medium slurry, make sure it is homogeneous by vortexing the vial thoroughly.
2. When the beads are resuspended, immediately pipette the required amount of bead slurry into the desired tube.
3. Due to the fast sedimentation of the beads, it is important to repeat the resuspension step between each pipetting.


## Handling liquids

1. Before application of liquid, remove the magnet from the magnetic rack.
2. After addition of liquid, resuspend the beads by vortexing or manual inversion of the tube. When processing multiple samples, manual inversion of the magnetic rack is recommended.
3. Pipette or pour off the liquid.

 If needed, a pipette can be used to remove liquid from the lid of the test tube.

## Incubation

During incubation, make sure the magnetic beads are well resuspended and kept in solution by end-over-end mixing or by using a benchtop shaker.

 When purifying samples of large volumes, an increase of the incubation time may be necessary.

## Sample and buffer preparation

Refer to *Purification of histidine-tagged proteins secreted into eukaryotic cell culture supernatants using Ni Sepharose excel* earlier in this chapter for a general procedure for sample and buffer preparation.

## Purification

### Magnetic bead preparation


1. Mix the bead slurry thoroughly by vortexing. Dispense 200  $\mu$ L of homogeneous slurry into a 1.5 mL test tube.
2. Place the test tube in the magnetic rack.
3. Remove the storage solution.

### Equilibration

4. Add 500  $\mu$ L of binding buffer.
5. Resuspend the beads.
6. Remove the liquid.

### Sample application


7. Immediately after equilibration, transfer the beads into a larger test tube containing 10 mL of sample.
8. Resuspend the beads and incubate for 4 h with slow end-over-end mixing.
9. Remove the liquid.

 For higher recovery when purifying weakly binding proteins, it is recommended to extend the incubation time to overnight.



## Washing

10. Add 500  $\mu\text{L}$  of wash buffer and retransfer the beads to a 1.5 mL test tube.
11. Resuspend the beads
12. Remove the liquid.
13. Wash three times in total.

 If the wash buffer contains imidazole, do not leave the beads in wash buffer for longer than 1 min because this may lead to loss of the target protein.

## Elution

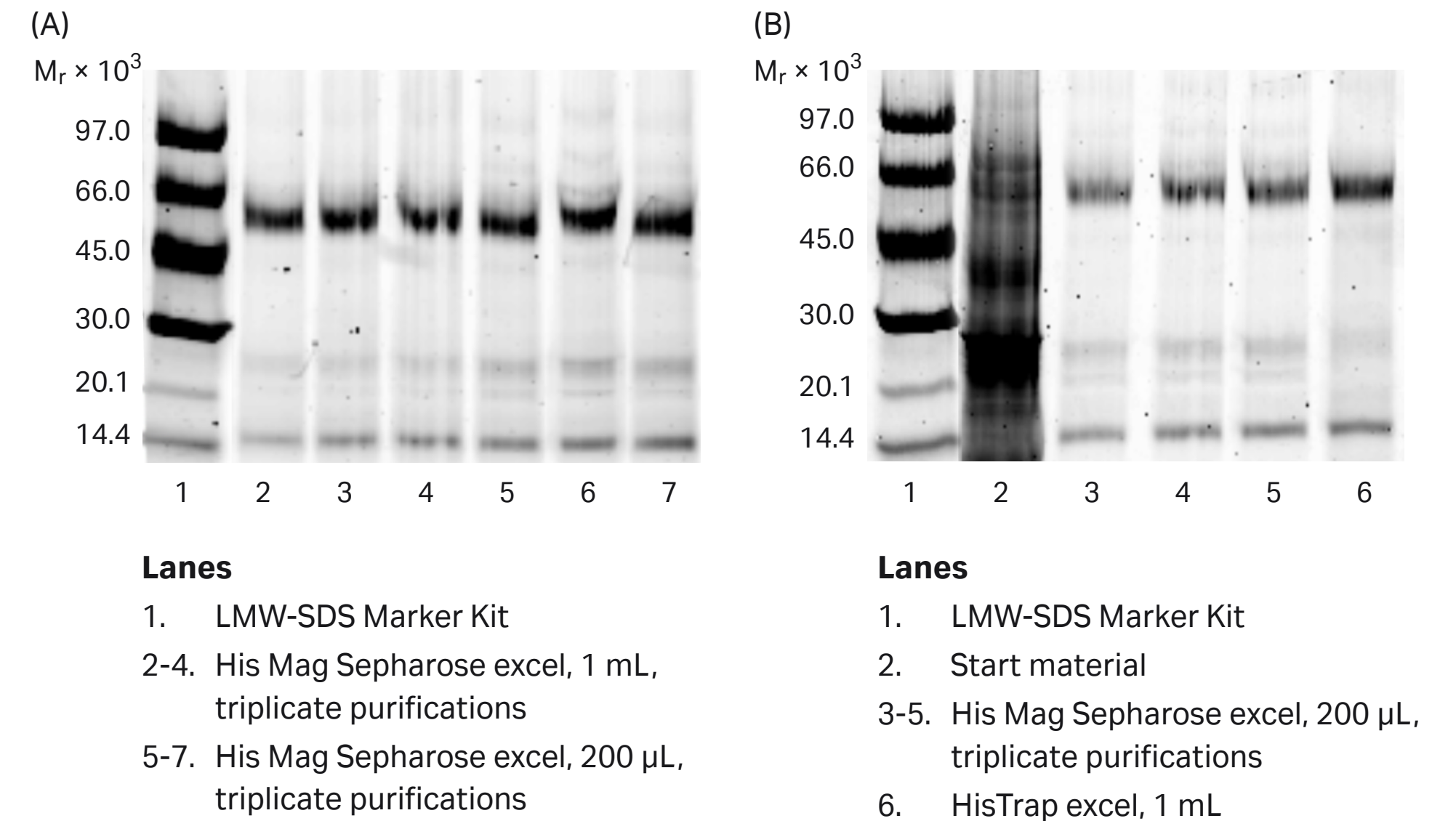
14. Add 200  $\mu\text{L}$  of elution buffer.
15. Resuspend the beads and incubate for 1 min with occasional mixing on a vortex mixer.
16. Collect the elution fraction. The collected elution fraction contains the main part of the purified protein.  
For optimal recovery, repeat the elution.

## Application example

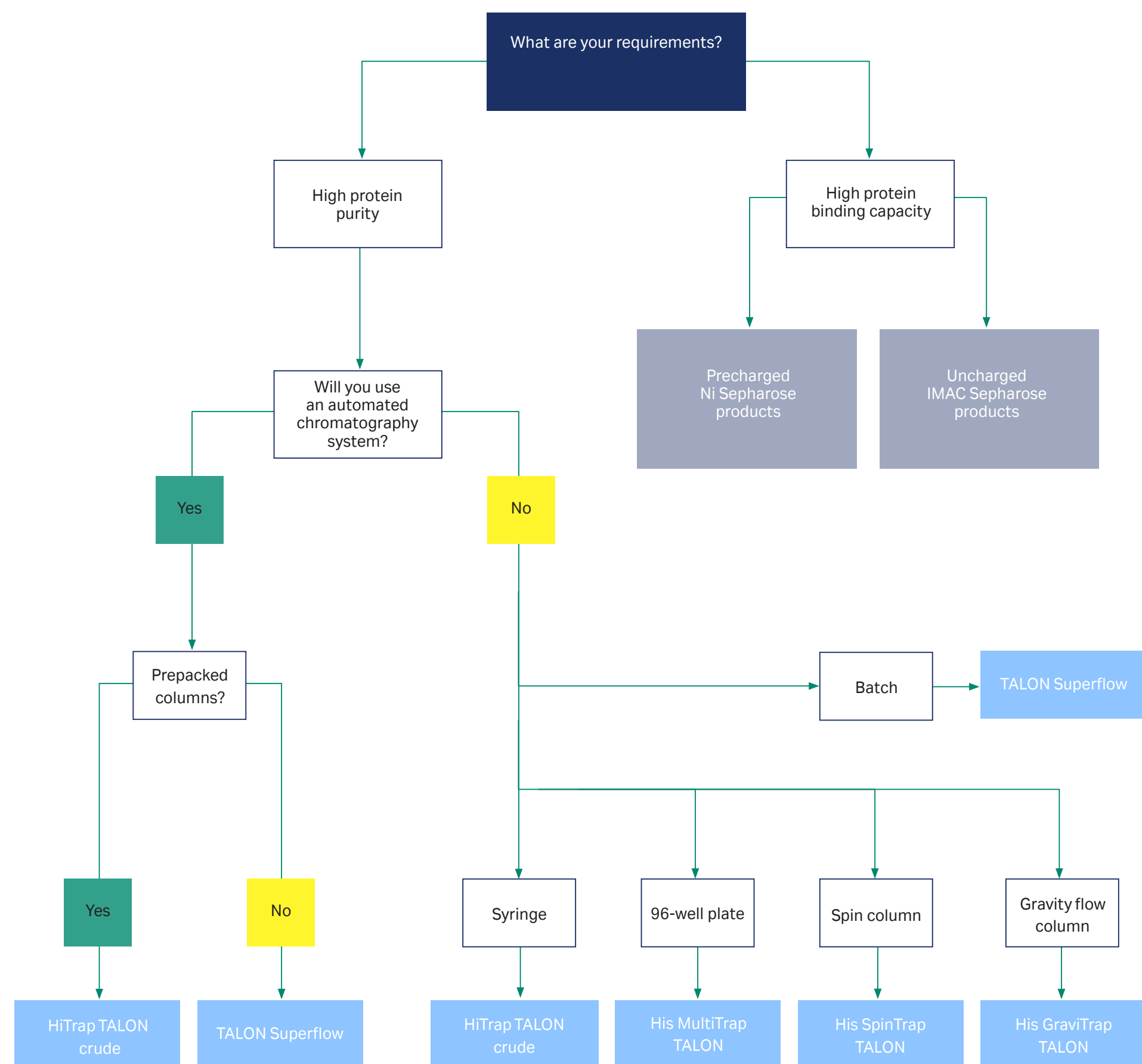
### Scale-up using His Mag Sepharose excel and HisTrap excel

The flexibility of His Mag Sepharose excel was investigated by a 5-fold purification scale-up of histidine-tagged prolylcarboxypeptidase PRCP-(his)<sub>9</sub>. Figure 3.35A shows the eluted pools from purifications using different medium slurry volumes. Recovery and purity were found to differ less than 10% between small and large scale. A 50-fold purification scale-up was performed comparing 200  $\mu\text{L}$  of His Mag Sepharose excel 10% medium slurry with column purification on HisTrap excel 1 mL (step elution). The results in Figure 3.35B demonstrate comparable purity and recovery between the formats, thus confirming the reliability of purification scale-up from magnetic beads to column format.

<i>Medium/column:</i>	His Mag Sepharose excel	His Mag Sepharose excel	HisTrap excel
<i>Medium slurry/bed volume:</i>	200 $\mu\text{L}$ 10% medium slurry	1 mL 10% medium slurry	1 mL
<i>Sample volume:</i>	10 mL	50 mL	500 mL
<i>Sample:</i>	PRCP-(his) <sub>9</sub> secreted into SAFC™ EX-CELL™ 405 medium, pH 6.9		
<i>Binding buffer:</i>	20 mM sodium phosphate, 500 mM NaCl, pH 7.4		
<i>Wash buffer:</i>	20 mM sodium phosphate, 500 mM NaCl, 30 mM imidazole, pH 7.4		
<i>Elution buffer:</i>	20 mM sodium phosphate, 500 mM NaCl, 500 mM imidazole, pH 7.4		



**Fig 3.35.** SDS-PAGE analysis of eluted pools from purification of PRCP-(his)<sub>9</sub> ( $M_r$  54 600) secreted into insect cell culture supernatant with scale-up from (A) 200  $\mu\text{L}$  of His Mag Sepharose excel slurry to 1 mL of His Mag Sepharose excel slurry; (B) 200  $\mu\text{L}$  of His Mag Sepharose excel slurry to HisTrap excel 1 mL. Purifications using His Mag Sepharose excel were performed in triplicate. The SDS-polyacrylamide gels (reducing conditions) were analyzed with ImageQuant™ TL software. The cell culture supernatant was kindly provided by Drs. Wolfgang Knecht (CVGI iMed Bioscience) and Paul Wan (Discovery Sciences), AstraZeneca R&D, Mölndal, Sweden.



**Fig 3.36.** Selection guide for TALON Superflow products.

## Purification using TALON Superflow products

Figure 3.36 provides a selection guide for the TALON Superflow products. The medium is a cobalt-charged IMAC medium offering enhanced selectivity for histidine-tagged proteins compared with nickel-charged chromatography media. It is the first-choice precharged medium when protein purity is more important than target protein yield.

## Purification using TALON Superflow

TALON Superflow consists of highly cross-linked agarose beads with an immobilized chelating group precharged with  $\text{Co}^{2+}$  ions.

The medium binds polyhistidine-tagged proteins with high selectivity and exhibits a reduced affinity for host proteins, giving lower background compared with other IMAC media. The medium is compatible with many aqueous buffers, denaturants, and a range of other additives (see Appendix 1). Avoid using DTT (dithiothreitol), DTE (dithioerythritol), and TCEP (TRIS (2-carboxyethyl) phosphine) with TALON Superflow products. Protein binding capacity will decrease rapidly if used. The medium is suitable for batch purification, and can also be used for packing into liquid chromatography columns such as Tricorn or XK columns. The medium usually works well with protocols designed for  $\text{Ni}^{2+}$ -based IMAC columns.





**Fig 3.37.** TALON Superflow allows for protein purification under native or denaturing conditions and can be used with prokaryotic and eukaryotic expression systems. TALON Superflow is available in 10 and 50 mL volumes.






## Sample preparation

This sample preparation procedure is applicable for all formats containing TALON Superflow. See *Cell lysis* earlier in this chapter for a general description.

-  Adjust the sample to the composition and pH of the binding buffer by adding buffer, NaCl, imidazole, and additives from concentrated stock solutions; by diluting the sample with binding buffer; or by buffer exchange.
-  Pass the sample through a 0.22  $\mu\text{m}$  or a 0.45  $\mu\text{m}$  filter and/or centrifuge it immediately before sample application. Filtration is not necessary when using HiTrap TALON crude and His GraviTrap. If the sample is too viscous, dilute it with binding buffer; increase lysis treatment (sonication, homogenization); or add DNase/RNase to reduce the size of nucleic acid fragments.

## Buffer preparation


Binding buffer: 50 mM sodium phosphate, 300 mM NaCl, pH 7.4  
Wash buffer: 50 mM sodium phosphate, 300 mM NaCl, 5 mM imidazole, pH 7.4  
Elution buffer: 50 mM sodium phosphate, 300 mM NaCl, 150 mM imidazole, pH 7.4

-  Water and chemicals used for buffer preparation should be of high purity. Filter buffers through a 0.45  $\mu\text{m}$  filter before use. Use high-purity imidazole, which gives essentially no absorbance at 280 nm.
-  Nonspecific binding of proteins due to electrostatic interactions can be decreased by increasing the NaCl concentration up to 500 mM.
-  The imidazole concentration required for wash and elution is protein dependent. See Chapter 4 for further information.

## Column packing


TALON Superflow is supplied preswollen in 20% ethanol. Prepare a slurry by decanting the 20% ethanol solution and replacing it with distilled water in a ratio of 75% settled medium to 25% distilled water.

1. Assemble the column (and packing reservoir if necessary).
2. Remove air from the end-piece and adapter by flushing with water. Make sure no air has been trapped under the column bed support. Close the column outlet leaving the bed support covered with water.
3. Resuspend the medium and pour the slurry into the column in a single continuous motion. Pouring the slurry down a glass rod held against the column wall will minimize the introduction of air bubbles.
4. If using a packing reservoir, immediately fill the remainder of the column and reservoir with water. Mount the adapter or lid of the packing reservoir and connect the column to a pump. Avoid trapping air bubbles under the adapter or in the inlet tubing.
5. Open the bottom outlet of the column and set the pump to run at the desired flow rate. This should be at least 133% of the flow rate to be used during subsequent chromatographic procedures. However, the maximum flow rate is typically employed during packing.

-  For subsequent chromatography procedures, do not exceed 75% of the packing flow rate.




6. Maintain the packing flow rate for at least 3 bed volumes after a constant bed height is reached. Mark the bed height on the column.
7. Stop the pump and close the column outlet.
8. If using a packing reservoir, disconnect the reservoir and fit the adapter to the column.
9. With the adapter inlet disconnected, push the adapter down into the column until it reaches the mark. Allow the packing solution to flush the adapter inlet. Lock the adapter in position.
10. Connect the column to a pump or a chromatography system and start equilibration. Re-adjust the adapter if necessary.

 For subsequent chromatography procedures, do not exceed 75% of the packing flow rate.

## Purification

### Purification procedure for a packed column

1. If the column contains 20% ethanol, wash it with 5 bed volumes of distilled water. Use a flow velocity of 50 cm/h to 100 cm/h. See Appendix 8 for information on converting flow velocity (cm/h) to volumetric flow rate (mL/min).
2. Equilibrate the column with 5 to 10 bed volumes of binding buffer. Recommended flow velocity: 150 cm/h.

 In some cases, a blank run is recommended before final equilibration/ sample application. See below for blank run.

3. Apply the pretreated, filtered, or centrifuged sample.
4. Wash with wash buffer until the absorbance reaches the baseline.
5. Elute with elution buffer using a step or linear gradient. For step elution, 8 bed volumes of elution buffer are usually sufficient. A shallow gradient, for example a linear gradient over 20 bed volumes, may separate proteins with similar binding strengths.

### Blank run:

Leakage of  $\text{Co}^{2+}$  from TALON Superflow is low under all normal conditions. For very critical applications, leakage during purification can be even further reduced by performing a blank run before loading sample.

1. Wash the column with 5 column volumes of distilled water.
2. Wash with 5 column volumes of elution buffer.
3. Equilibrate with 10 column volumes of binding buffer.

## High-throughput screening using His MultiTrap TALON

His MultiTrap TALON 96-well filter plates are prepacked with 50  $\mu$ L of TALON Superflow per well. Each plate provides highly reproducible high-throughput screening and rapid small-scale purification of histidine-tagged proteins. Typical applications include expression screening of different constructs, screening for solubility of proteins, and optimization of the conditions for small-scale parallel purification. Purification of up to 1 mg of histidine-tagged proteins per well is possible. The 96-well plate format gives great flexibility, both when working with automated robotic systems and when manually using centrifugation or vacuum. Consistent well-to-well and plate-to-plate performance ensures high reproducibility in yield and purity. See Appendix 1 for the main characteristics of His MultiTrap TALON.

### Sample and buffer preparation

Refer to *Purification using TALON Superflow* earlier in this chapter for a general procedure for sample and buffer preparation.

### Purification

Purification with His MultiTrap TALON can be performed either by using centrifugation or vacuum pressure.

### Purification protocol using centrifugation

This protocol is a general guideline for the purification with His MultiTrap TALON. Optimization may be required depending on source and type of protein.



**Fig 3.38.** His MultiTrap TALON prepacked 96-well plates for expression screening and small-scale parallel purification of histidine-tagged proteins.

### Remove storage solution

1. Remove the bottom seal.
2. Gently shake the 96-well filter plate while holding it upside down, to remove any medium stuck on the top seal. Place the plate in upright position.
3. Remove the top seal from the plate while holding it against the bench surface.
4. Position the plate on top of a collection plate.

 Remember to change or empty the collection plate when necessary during the following steps.

5. Centrifuge the plates for 2 min at 500 × g, to remove the storage solution from the medium.

### Prewash


6. Add 500 µL of deionized water per well.
7. Centrifuge for 2 min at 500 × g.

### Equilibrate

8. Add 500 µL of binding buffer/well and mix briefly, to equilibrate the medium.
9. Centrifuge for 2 min at 500 × g.
10. Repeat once.

### Load sample

11. Apply sample to the wells (maximum 600 µL/well).

 After thorough cell disruption, it is possible to apply the unclarified sample directly without experiencing problems of clogging. However, it is recommended to clarify the sample for optimal recovery.

12. Incubate for 3 min. (Increase the incubation time if the yield is too low.)
13. Remove the flowthrough by centrifuging for 4 min at 100 × g (or until all wells are empty).

### Wash

14. Add 500 µL of wash buffer/well to wash out unbound sample.
15. Centrifuge for 2 min at 500 × g.
16. Repeat once (or until all unbound sample is removed).

### Elute






17. Add 200 µL<sup>1</sup> of elution buffer/well and mix for 1 min.
18. Change collection plate and centrifuge the plates for 2 min at 500 × g, and collect the fractions.
19. Repeat twice (or until all target protein has been eluted).
20. If required, change collection plate between each elution (to prevent unnecessary dilution of the target protein).

<sup>1</sup> The volumes can be varied depending on which concentration of target protein is needed (e.g., 50 or 100 µL of elution buffer/well).



## Purification protocol using vacuum pressure


This protocol is only a general guideline for the purification with His MultiTrap TALON. Optimization may be required depending on source and type of protein.

-  If a problem with cross-contamination due to foaming, poor reproducibility or bubbles in the collection plate occurs using vacuum, decrease load of protein (< 0.5 mg protein bound to medium). If this does not solve the problem, the centrifugation protocol should be considered.
-  To avoid cross-contamination, the distance between MultiTrap and collection plate should be as narrow as possible (not more than 5 mm).
-  Use deep round well collection plates (500 µL) to avoid splashes between wells.
-  A vacuum pressure of -150 mbar (30 s) followed by -300 mbar (<3 s) should be used during elution of purified protein.
-  Vacuum parameters need to be optimized for each vacuum manifold.

## Purification

### Remove storage solution

1. Remove the bottom seal.
2. Gently shake the 96-well filter plate while holding it upside down, to remove any medium stuck on the top seal. Place the plate in an upright position.
3. Remove the top seal from the plate while holding it against the bench surface.
4. Place the 96-well filter plate on the vacuum manifold. Remove the storage solution from the medium by applying a vacuum pressure of -300 mbar for 20 s.

-  Position the filter plate on top of a collection plate. Remember to change or empty the collection plate when necessary during the following steps.

### Prewash


5. Add 500 µL of deionized water/well.
6. Remove the water from the wells by applying a vacuum pressure of -300 mbar for 20 s.

### Equilibrate


7. Add 500 µL of binding buffer/well to equilibrate the medium.
8. Remove the solution by applying a vacuum pressure of -300 mbar for 20 s.
9. Repeat once.

### Load sample

10. Apply sample to the wells (maximum 600 µL/well).

-  After thorough cell disruption, it is possible to apply the unclarified sample directly without experiencing problems of clogging. However, it is recommended to clarify the sample for optimal recovery.


11. Incubate for 3 min. (Increase the incubation time and gently mix the filter plate if the yield is too low.)

-  In purifications using a robot, the vacuum must be adjusted to methods applicable to the robot.

12. Remove the flowthrough by applying a vacuum pressure of -150 mbar until all wells are empty (30 to 50 s).

## Wash

13. Add 500  $\mu\text{L}$  of wash buffer/well to wash out unbound sample.
14. Remove the solution by applying a vacuum pressure of -150 mbar for 30 s.

 -300 mbar for 20 s could also be used if the waste will not be collected.

15. Repeat twice (or until all unbound sample is removed).

## Elute

16. Add 200  $\mu\text{L}$  of elution buffer<sup>1</sup> and mix for 1 min.
17. Change/add collection plate and elute the sample using vacuum by applying a vacuum pressure of -150 mbar for 30 s followed by applying a vacuum pressure of -300 mbar for < 3 s, or until all droplets under the plate are removed.
18. Repeat twice (or until all target protein has been eluted).
19. If required, change collection plate between each elution to prevent unnecessary dilution of the target protein.

<sup>1</sup> The volumes can be varied depending on the concentration of target protein needed, e.g., 50 or 100  $\mu\text{L}$  of elution buffer/well.

 Increasing the vacuum too fast can give foam under the filter plate, and cross-contamination can occur.

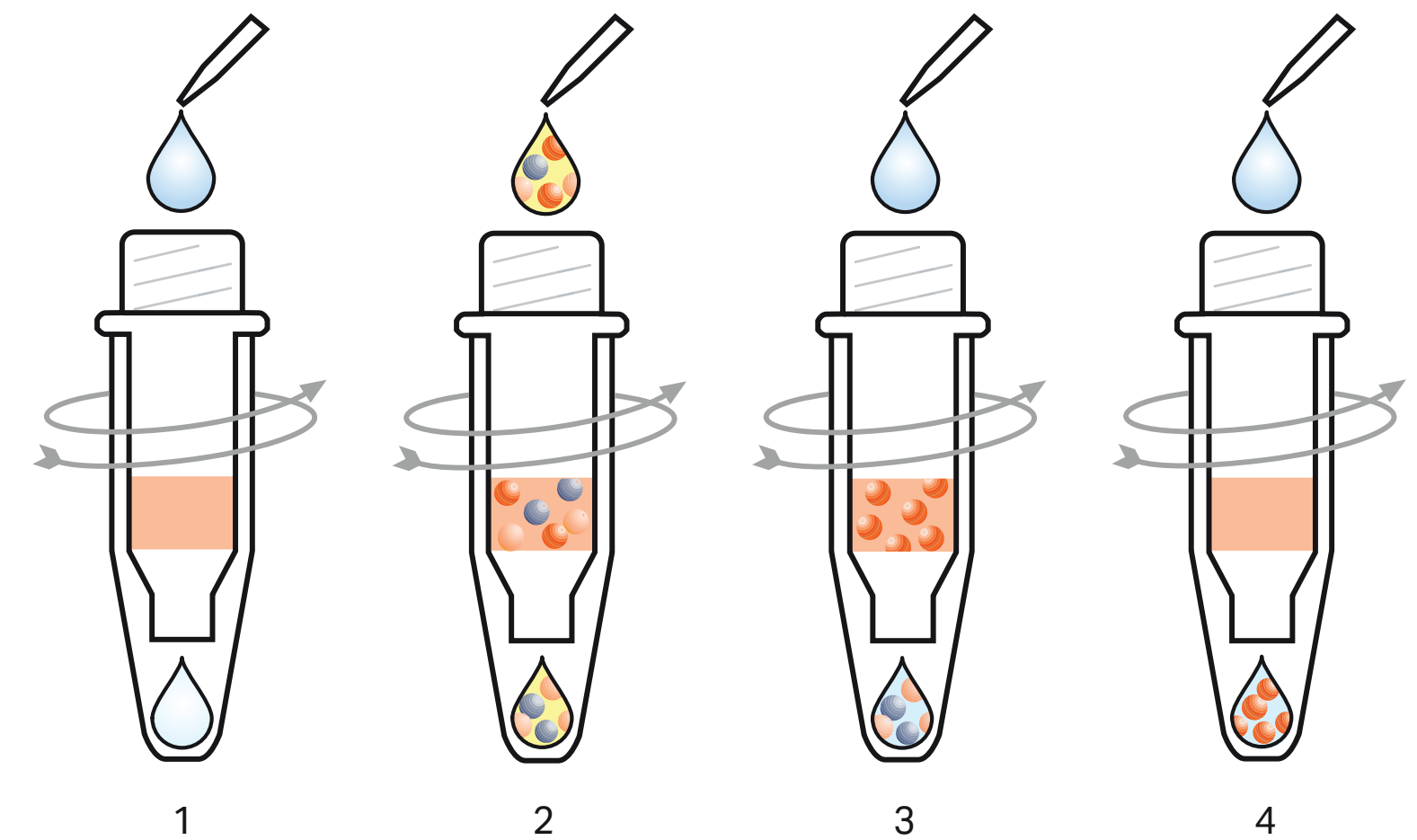
## Rapid screening using His SpinTrap TALON

His SpinTrap TALON columns are excellent for screening of expression levels and purification conditions prior to scale up. The columns are designed for use in a microcentrifuge. Figure 3.40 shows the rapid purification procedure using His SpinTrap TALON, taking approximately 10 min. The prepacked columns enable highly reproducible column-to-column results in yield and purity.

Each column contains 100  $\mu\text{L}$  of TALON Superflow, enough for purifying up to 1 mg of histidine-tagged protein. See Appendix 1 for the main characteristics of His SpinTrap TALON.



**Fig 3.39** His SpinTrap TALON is a single-use spin column for high-purity purification of histidine-tagged proteins.



**Fig 3.40.** Purifying histidine-tagged proteins with His SpinTrap TALON is a simple four-stage procedure that can be performed in 10 min using a microcentrifuge: 1) After placing the column in a 2 mL microcentrifuge tube, equilibrate by adding binding buffer and centrifuge. 2) Add sample, centrifuge. 3) Wash with binding buffer, centrifuge. 4) Elute the target protein with elution by centrifugation.

## Sample and buffer preparation

Refer to *Purification using TALON Superflow* earlier in this chapter for a general procedure for sample and buffer preparation.

## Purification

Run purifications on His SpinTrap TALON using a standard microcentrifuge. Place the column in a 2 mL microcentrifuge tube to collect the liquid during centrifugation. Use a new 2 mL tube for every step.

### Remove storage solution


1. Invert and shake the column repeatedly to resuspend the medium.
2. Loosen the top cap one-quarter of a turn and break off the bottom closure.
3. Place the column in a 2 mL microcentrifuge tube and centrifuge for 30 s at 70 to 100 × g.

### Column equilibration


4. Add 600 µL of binding buffer.
5. Centrifuge for 30 s at 70 to 100 × g.

### Sample application

6. Add up to 600 µL of sample in one application.

 After thorough cell disruption, it is possible to apply the unclarified sample directly without clogging. However, it is recommended to clarify the sample for optimal recovery.

7. Seal the column with the top cap and bottom closure, and incubate the sample for 5 min with slow end-over-end mixing.
8. Remove the top cap and bottom closure, and centrifuge for 30 s at 70 to 100 × g.

 Several sample applications can be performed as long as the capacity of the column is not exceeded.

### Wash

9. Add 600 µL of wash buffer.
10. To increase the yield, close the column with the top cap and bottom closure, and resuspend.
11. Remove the top cap and bottom closure, and centrifuge for 30 s at 70 to 100 × g.
12. Repeat this step once.

### Elution

13. Add 200 µL of elution buffer.
14. To increase the yield, close the column with the top cap and bottom closure, and resuspend.
15. Remove the top cap and bottom closure, centrifuge for 30 s at 70 to 100 × g, and collect the purified sample.
16. Repeat this step once.

 The first eluted 200 µL will contain the majority of the target protein.



## Manual purification using His GraviTrap TALON

His GraviTrap TALON columns are prepacked with 1 mL of TALON Superflow medium. Each column provides simple manual purification of up to 15 mg of histidine-tagged proteins. The different purification steps are performed using gravity flow and require no further equipment (Fig 3.42). Large sample volumes can be applied in one go, and the histidine-tagged protein is effectively eluted in a small volume. Each package contains 10 prepacked columns, and each column is delivered in a package that converts into a column stand (Workmate). The plastic tray in the product package can be used to collect liquid waste. The columns are manufactured from biocompatible polypropylene, and special frits in each column protect the medium from running dry during purification. See Appendix 1 for the main characteristics of His GraviTrap TALON.

### Sample and buffer preparation

Refer to *Purification using TALON Superflow* earlier in this chapter for a general procedure for sample and buffer preparation.

### Purification


The protein binding capacity of the column is approximately 15 mg of histidine-tagged protein/column (protein dependent). Connecting LabMate reservoir (see *Ordering information*) to the column increases convenience when handling volumes above 10 mL. This raises the loading capacity to approximately 35 mL in one run.

#### Prepare and equilibrate

1. Cut off the bottom tip, remove the top cap, pour off excess liquid, and place the column in the Workmate column stand.
2. If needed, mount LabMate on top of the column.
3. Equilibrate the column with 10 mL of binding buffer. The frits protect the column from running dry during the run.

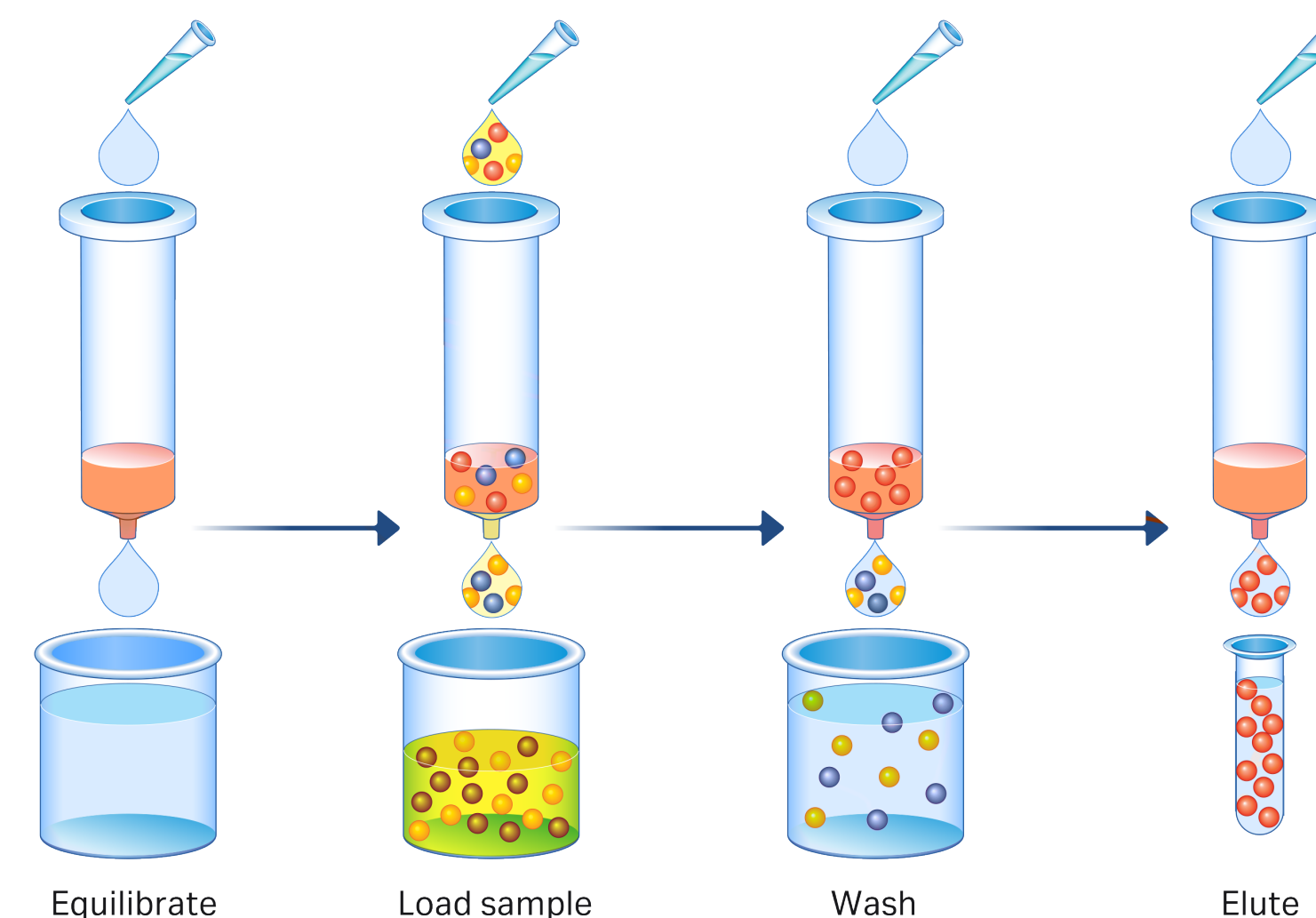
#### Load sample

4. Add the sample. A volume of 0.5 to 35 mL is recommended.

 After thorough cell disruption, it is possible to apply the unclarified sample directly to the column without experiencing clogging problems.



**Fig 3.41.** His GraviTrap TALON is a prepacked gravity-flow column for convenient manual purification of histidine-tagged proteins.



**Fig 3.42.** Schematic workflow for purifying histidine-tagged proteins on His GraviTrap TALON.

### Wash

5. Wash with 10 mL of wash buffer.

### Elute

6. Apply 3 mL of elution buffer, and collect the eluate.

7. Under denaturing conditions, elute with 2 × 3 mL of elution buffer.

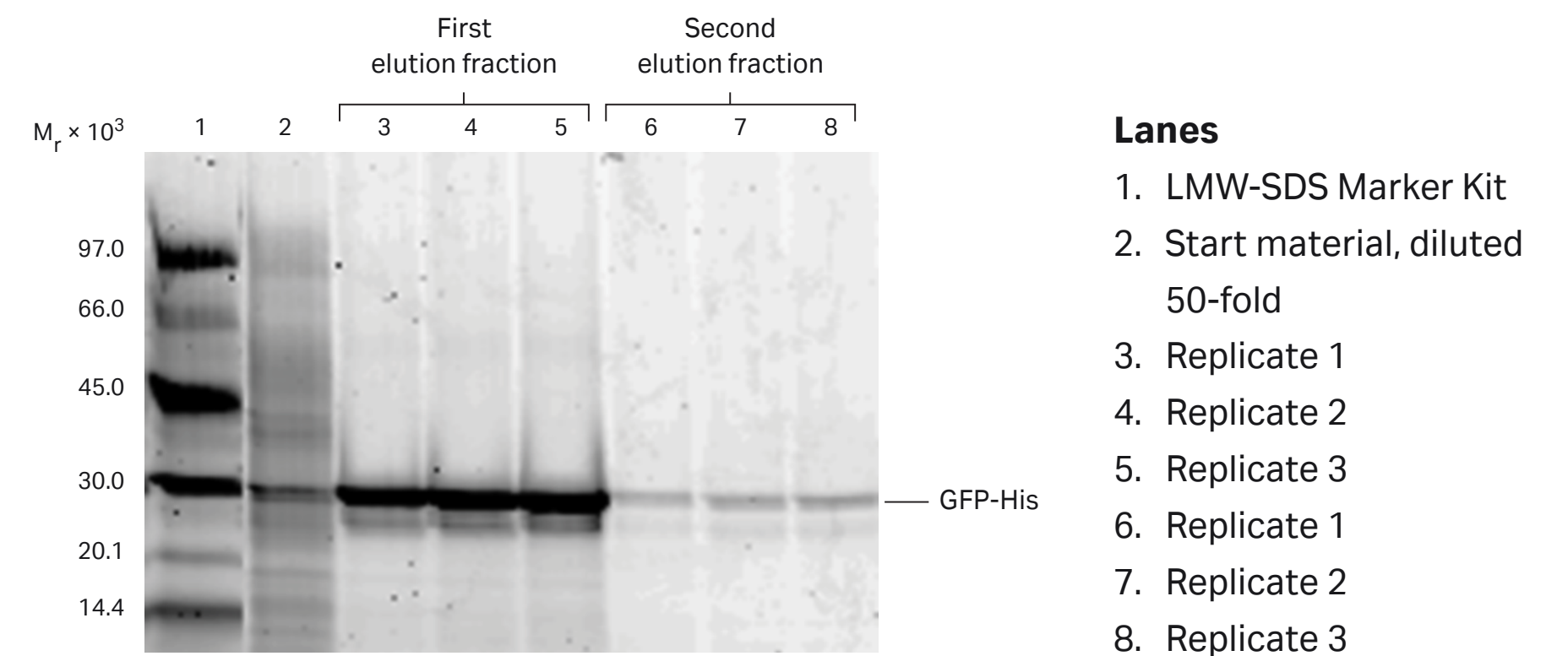
 If using buffers that contain denaturing agents or viscous solutions, perform the purification at room temperature.

## Application example

### Simple and rapid protein purification using His GraviTrap TALON

His GraviTrap TALON enables fast and easy manual purification of histidine-tagged proteins without the need of a purification system. Using a gravity-flow protocol, histidine-tagged green fluorescent protein (GFP-His) added to *E. coli* lysate was purified with His GraviTrap TALON in less than 30 min. The recovery was calculated using absorbance measurements and was found to be 95%. Figure 3.43 shows the SDS-PAGE analysis of the first and second elution fractions. The results indicate a purity of ≥ 93% for the purified GFP-His protein.

**Column:** His GraviTrap TALON  
**Sample:** GFP-His (1 mg/mL) added to *E. coli* lysate, prepared by enzymatic lysis and sonication  
**Sample volume:** 8 mL  
**Binding buffer:** 50 mM NaH<sub>2</sub>PO<sub>4</sub>, 300 mM NaCl, pH 7.4  
**Wash buffer:** 50 mM NaH<sub>2</sub>PO<sub>4</sub>, 300 mM NaCl, 5 mM imidazole, pH 7.4  
**Elution buffer:** 50 mM NaH<sub>2</sub>PO<sub>4</sub>, 300 mM NaCl, 150 mM imidazole, pH 7.4



**Fig 3.43.** SDS-PAGE analysis of elution fractions from a purification of GFP-His ( $M_r$  28 000) added to *E. coli* lysate. The SDS-polyacrylamide gel (reducing conditions) was analyzed with ImageQuant TL software. The experiment was performed in triplicate. The first elution fraction contained 96% of the purified protein.

## Purification using HiTrap TALON crude

HiTrap TALON crude is 1 mL and 5 mL HiTrap columns prepacked with TALON Superflow. The columns can be operated with either a syringe, a peristaltic pump, or a chromatography system such as ÄKTA. After thorough cell disruption, it is possible to load the unclarified lysate on the specially designed column without precentrifugation and filtration.


The HiTrap TALON crude column is made of biocompatible polypropylene that does not interact with biomolecules. Columns are delivered with a stopper on the inlet and a snap-off end on the outlet. See Appendix 1 for the main characteristics of HiTrap TALON crude.

### Sample and buffer preparation

Refer to *Purification using TALON Superflow* earlier in this chapter for a general procedure for sample and buffer preparation.

### Purification

1. Fill the pump tubing or syringe with distilled water. Remove the stopper and connect the column to the chromatography system tubing, syringe (use the adapter provided), or laboratory pump “drop-to-drop” to avoid introducing air into the system.
2. Remove the snap-off end at the column outlet.
3. Wash out the ethanol with 3 to 5 column volumes of distilled water.
4. Equilibrate the column with at least 5 column volumes of binding buffer. Recommended flow rates are 1 mL/min or 5 mL/min for the 1 mL and 5 mL columns, respectively. In some cases, a blank run is recommended before final equilibration/sample application.


 Leakage of  $\text{Co}^{2+}$  from TALON Superflow is low under all normal conditions. For very critical applications, leakage during purification can be even further reduced by performing a blank run before loading sample. See next page for blank run.

5. Apply the unclarified lysate with a pump or a syringe. Continuous stirring of the sample during sample loading may be necessary to prevent sedimentation.


Typical loading volumes of unclarified lysate (highly dependent on specific sample, sample pretreatment, and temperature at sample loading):

HiTrap TALON crude 1 mL: Up to 100 mL

HiTrap TALON crude 5 mL: Up to 500 mL

 Sample loading at 4°C may increase the viscosity of the sample. An adverse effect of increased sample viscosity is that maximum back pressure for the column is reached at a lower sample volume loading on the column. Do not exceed the maximum back pressure of the column. Large volumes may increase back pressure, making the use of a syringe more difficult.

6. Wash with wash buffer until the absorbance reaches a steady baseline (generally at least 15 to 20 column volumes).
7. Elute with elution buffer using a one-step procedure or a linear gradient.  
  
For step elution, 8 column volumes of elution buffer are usually sufficient. A shallow gradient, for example, a linear gradient over 20 column volumes or more, can separate proteins with similar binding strengths.

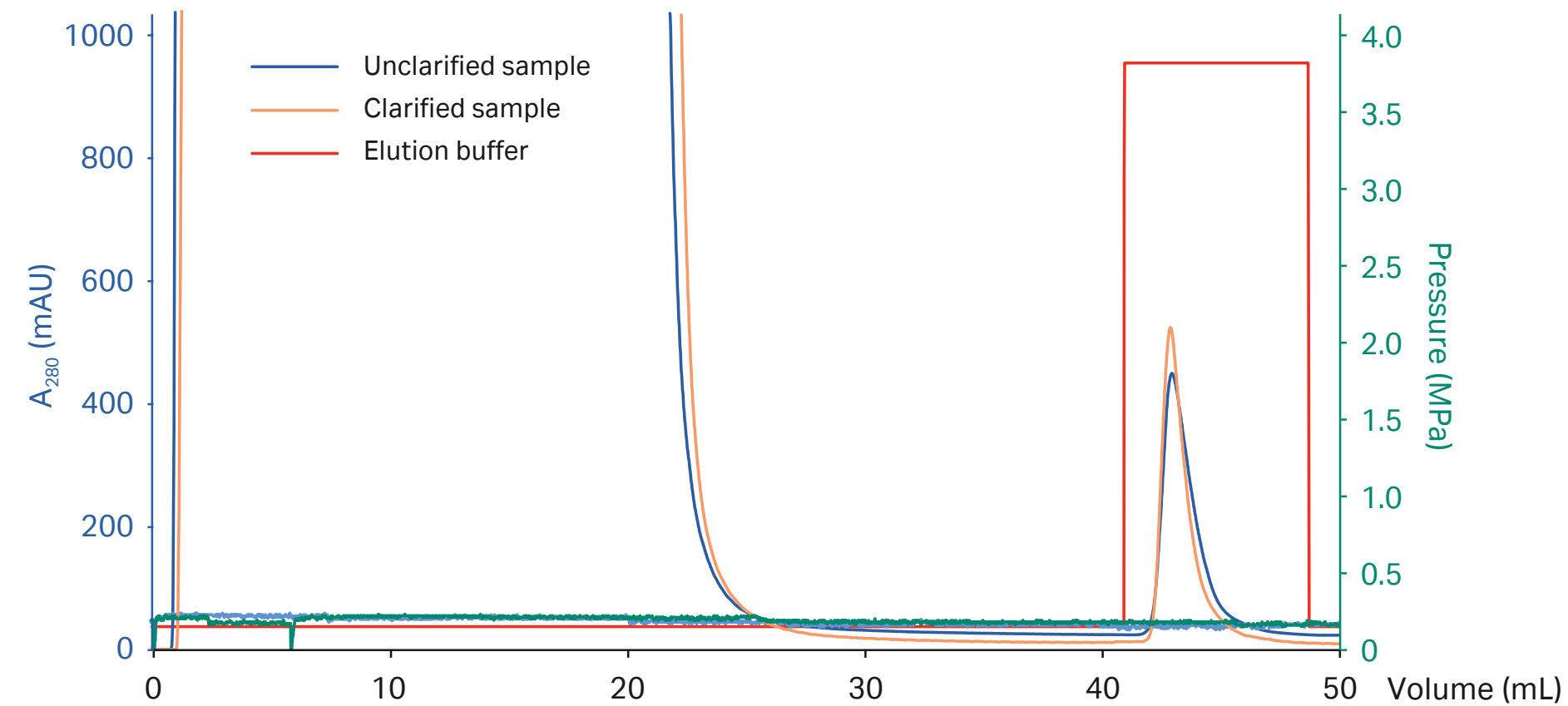
 For  $A_{280}$  measurements, use the elution buffers as blanks. If imidazole needs to be removed, use a desalting column (see Chapter 11). Low-quality imidazole will give a significant background absorbance at 280 nm.



### Blank run:

1. Wash the column with 5 column volumes of distilled water.
2. Wash with 5 column volumes of elution buffer.
3. Equilibrate with 10 column volumes of binding buffer.

Column:	HiTrap TALON crude 1 mL
Sample:	Unclearified and clarified <i>E. coli</i> lysate containing GEHC1-(His) <sub>6</sub> (M <sub>r</sub> 47 000)
Sample volume:	20 mL
Binding/wash buffer:	50 mM NaH <sub>2</sub> PO <sub>4</sub> , 300 mM NaCl, 5 mM imidazole, pH 7.4
Elution buffer:	50 mM NaH <sub>2</sub> PO <sub>4</sub> , 300 mM NaCl, 150 mM imidazole, pH 7.4
Flow rate:	1 mL/min
Detection:	Absorbance, 280 nm
System:	ÄKTA



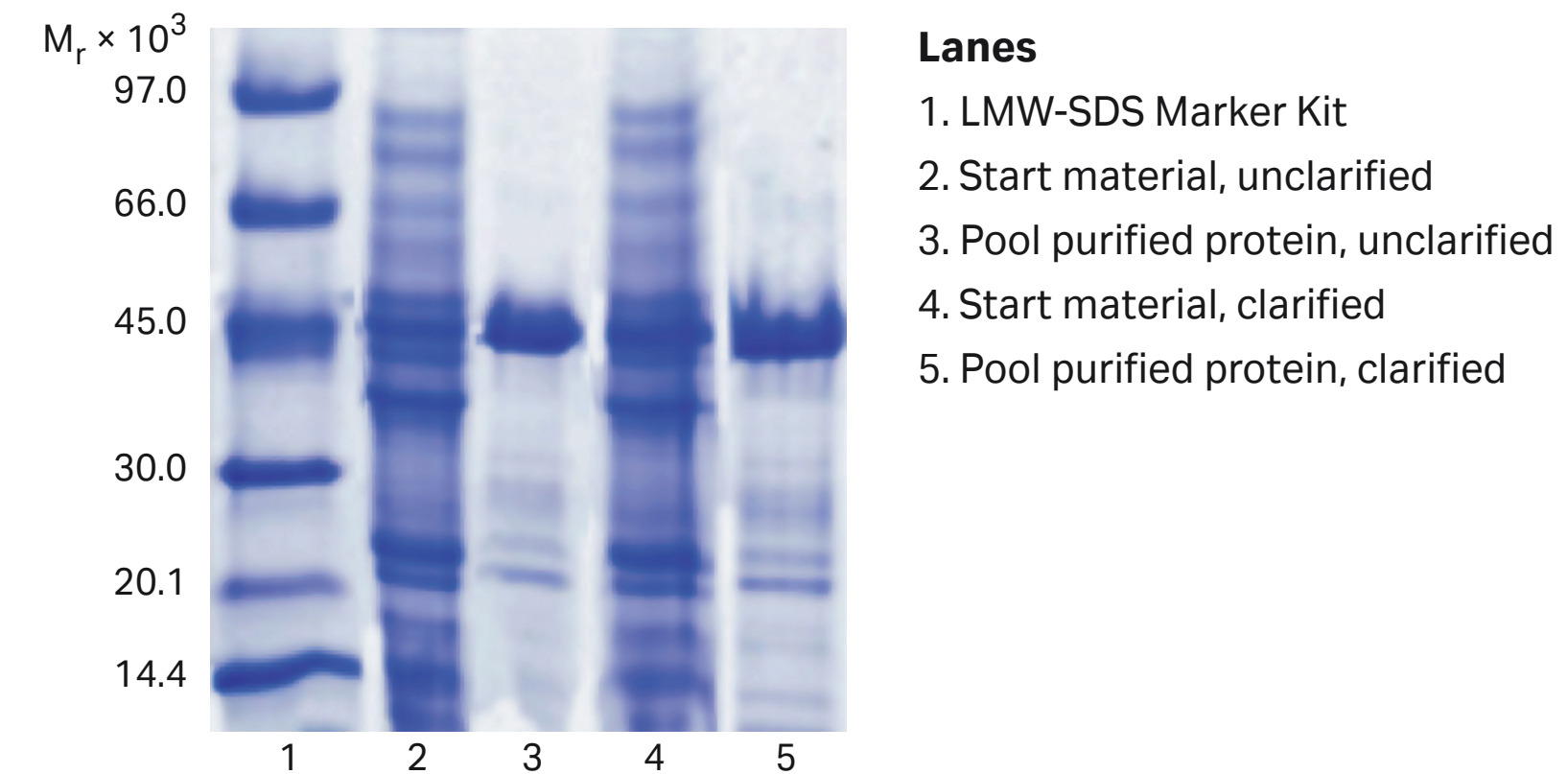
**Fig 3.44.** Comparison study loading unclarified (blue line) and clarified (orange line) *E. coli* samples containing the histidine-tagged protein GEHC1-(His)<sub>6</sub> on HiTrap TALON crude. Overlay of absorbance curves.

## Application example

### Yield and purity using unclarified vs clarified sample with HiTrap TALON crude

HiTrap TALON crude columns simplify purification by eliminating the need for precentrifugation and filtration steps. For comparison, unclarified and clarified (centrifugation at 30 000 × g for 20 min) *E. coli* extracts containing the histidine-tagged protein GEHC1-(His)<sub>6</sub> were loaded on HiTrap TALON crude 1 mL columns. After purification, purity (analyzed by SDS-PAGE) and yield (calculated from absorbance measurements) of eluted fraction pools were determined.

Figure 3.44 shows that purification using unclarified extract was similar to when clarified sample was used. The amount of GEHC1-(His)<sub>6</sub> eluted was 13 mg and 12 mg when loading unclarified and clarified sample, respectively. In addition, the purity did not significantly differ, and SDS-PAGE analysis showed high purity for both samples (> 90%; Fig 3.45). By eliminating the need for precentrifugation and filtration, HiTrap TALON crude columns saved approximately 40 min.



**Fig 3.45.** SDS-PAGE analysis (reducing conditions, ExcelGel SDS Gradient 8-18, Coomassie stained) of pools containing purified GEHC1-(His)<sub>6</sub>. Comparison of runs performed on HiTrap TALON crude using unclarified and clarified sample.

## Purification using uncharged chromatography media

IMAC Sepharose High Performance and IMAC Sepharose 6 Fast Flow are uncharged IMAC media from Cytiva. Uncharged media allow the user to select the most suitable metal ion and purification conditions for specific histidine-tagged and untagged target proteins. In general, IMAC Sepharose High Performance is recommended when high resolution and high capacity are important, whereas IMAC Sepharose 6 Fast Flow is recommended when scale-up is required.

IMAC Sepharose High Performance is available in lab packs and in prepacked HiTrap IMAC HP columns. IMAC Sepharose 6 Fast Flow is available in prepacked HiTrap IMAC FF columns, and for further scale-up, in HiPrep IMAC FF 16/10, 20 mL columns. For process development, prepacked HiScreen IMAC FF columns with 10 mL bed heights are used. These columns can be connected in series for increased capacity.

Table 3.3 summarizes the products containing uncharged IMAC media, and Figure 3.46 provides a selection guide for these products.

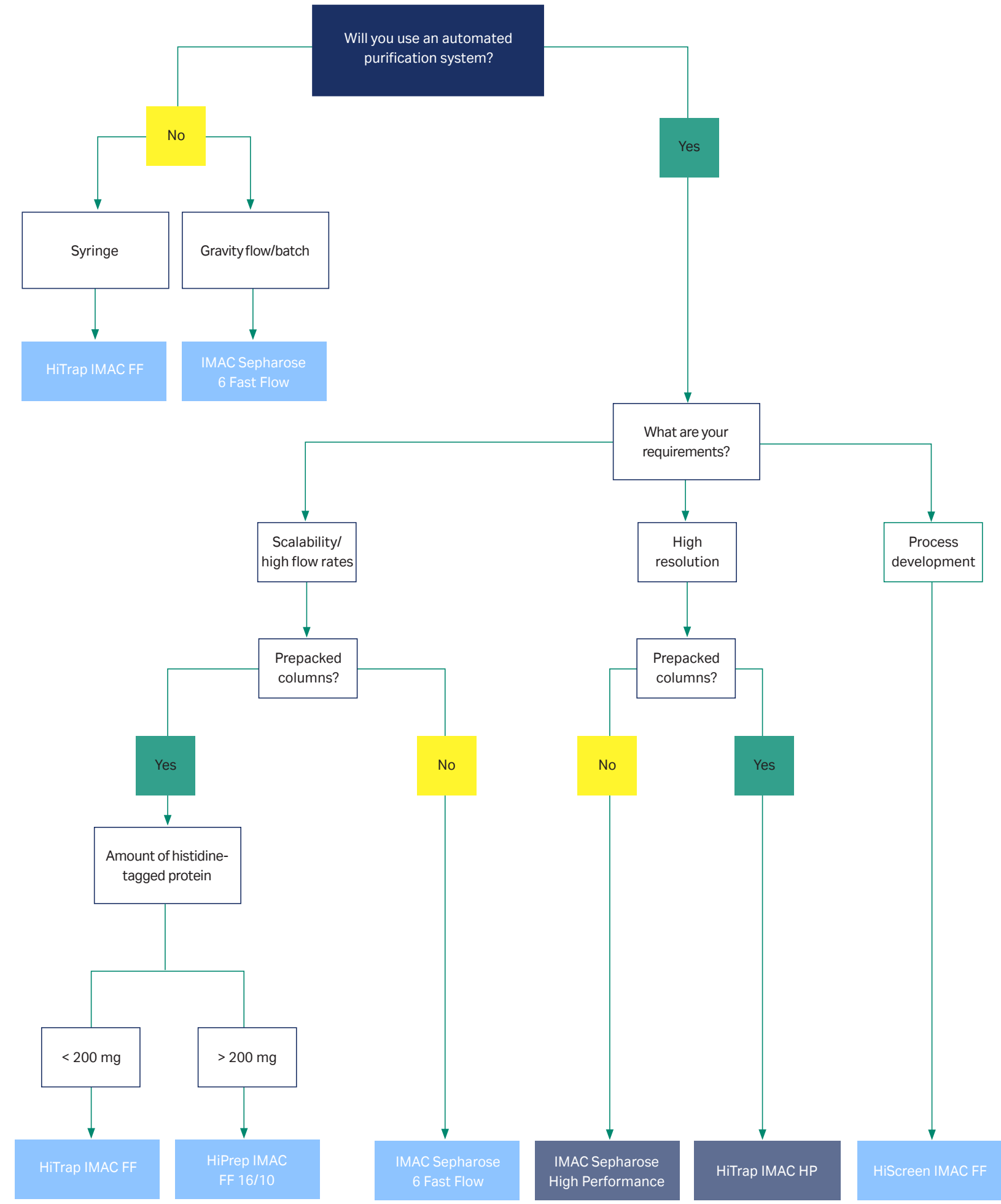
**Table 3.3.** Purification options for histidine-tagged proteins using uncharged IMAC Sepharose products

Product	Format or column size	Approx. protein binding capacity <sup>1</sup>	Description	High-throughput screening	Minipreps	Batch/gravity flow	Syringe compatible	Scale-up	AKTA system compatible	Process development
IMAC Sepharose High Performance	25 mL	40 mg/mL (Ni <sup>2+</sup> )	For high resolution and elution of a more concentrated sample (high-performance purification). Needs column packing or use in batch mode.	•				•	•	
	100 mL			•				•	•	
HiTrap IMAC HP	1 mL	40 mg/column (Ni <sup>2+</sup> )	For use mainly with a peristaltic pump or chromatography system. For high resolution and elution of a more concentrated sample (high-performance purification).					•	•	
	5 mL	200 mg/column (Ni <sup>2+</sup> )						•	•	
IMAC Sepharose 6 Fast Flow	25 mL	40 mg/mL (Ni <sup>2+</sup> )	Excellent for scale-up due to high capacity and high flow properties. Needs column packing or use in batch mode.	•	•	•		•	•	
	100 mL			•	•	•		•	•	
HiTrap IMAC FF	1 mL	40 mg/column (Ni <sup>2+</sup> )	For use with syringe, peristaltic pump, or chromatography system. Provides excellent flow properties. Scale-up.				•	•	•	
	5 mL	200 mg/column (Ni <sup>2+</sup> )					•	•	•	
HiScreen IMAC FF	4.7 mL	188 mg/column (Ni <sup>2+</sup> )	For use with a chromatography system. High flow properties for establishing optimal chromatographic conditions for scaling up.					•	•	•
HiPrep IMAC FF 16/10	20 mL	800 mg/column (Ni <sup>2+</sup> )	For use with a chromatography system. Scale-up purification.					•	•	
<b>Buffer kit</b>										
His Buffer Kit					•	•	•			

<sup>1</sup> Protein dependent

■ Contains IMAC Sepharose High Performance

■ Contains IMAC Sepharose 6 Fast Flow



■ Contains IMAC Sepharose High Performance  
 ■ Contains IMAC Sepharose 6 Fast Flow

## Purification using IMAC Sepharose High Performance

IMAC Sepharose High Performance is an uncharged chromatography medium consisting of 34 µm beads of highly cross-linked 6% agarose to which a chelating group has been covalently coupled. This chelating group will be charged with suitable metal ions by the user, allowing the medium to selectively retain target proteins. The small bead size allows high chromatographic resolution with distinctly separated peaks containing concentrated material. The chromatography medium is highly compatible with a range of additives and is well suited to high-performance purifications that produce concentrated products in the eluate. See Appendix 1 for the main characteristics of IMAC Sepharose High Performance. IMAC Sepharose High Performance is supplied preswollen in 20% ethanol.



**Fig 3.47.** IMAC Sepharose High Performance is supplied free of metal ions, enabling it to be used across a range of applications for purifying histidine-tagged as well as native proteins. It is available in 25 mL and 100 mL lab packs as well as prepacked HiTrap IMAC HP 1 mL and 5 mL columns.

**Fig 3.46.** Selection guide for uncharged IMAC Sepharose products.





## Packing a column

See instructions supplied with the product, or refer to Appendix 6 for general guidelines for column packing.

## Sample preparation

This sample preparation procedure is applicable for all formats containing IMAC Sepharose High Performance. See *Cell lysis* earlier in this chapter for a general description.


 Adjust the sample to the composition and pH of the binding buffer by adding buffer, NaCl, imidazole, and additives from concentrated stock solutions; by diluting the sample with binding buffer; or by buffer exchange. To prevent the binding of host cell proteins with exposed histidine, it is essential to include imidazole at a low concentration in the sample and binding buffer (see Chapter 4).


 Pass the sample through a 0.22  $\mu\text{m}$  or a 0.45  $\mu\text{m}$  filter and/or centrifuge it immediately before sample application. If the sample is too viscous, dilute it with binding buffer to prevent it from clogging; increase lysis treatment (sonication, homogenization); or add DNase/RNase to reduce the size of nucleic acid fragments.

## Buffer preparation

Binding buffer: 20 mM sodium phosphate, 0.5 M NaCl, 20 to 40 mM imidazole, pH 7.4. (The optimal imidazole concentration is protein dependent; 20 to 40 mM is suitable for many proteins.)


Elution buffer: 20 mM sodium phosphate, 0.5 M NaCl, 500 mM imidazole, pH 7.4.

 Water and chemicals used for buffer preparation should be of high purity. Filter buffers through a 0.45  $\mu\text{m}$  filter before use. Use high-purity imidazole, as this will give a very low or no absorbance at 280 nm.


 The optimal concentration of imidazole needed in the sample and buffer to obtain the best purity and yield differs from protein to protein. In the binding buffer, 20 to 40 mM imidazole is suitable for many proteins; 500 mM imidazole in the elution buffer ensures complete elution of the target protein.


## Charging the chromatography medium with metal ion


1. Prepare a 0.1 M solution of the desired metal ion (e.g.,  $\text{Cu}^{2+}$ ,  $\text{Zn}^{2+}$ ,  $\text{Co}^{2+}$ ,  $\text{Fe}^{3+}$ , or  $\text{Ni}^{2+}$ ) in distilled water. Salts of chlorides, sulfates, etc., can be used (e.g., 0.1 M  $\text{CuSO}_4$  or 0.1 M  $\text{NiSO}_4$ ).


 Solutions of  $\text{Zn}^{2+}$  ions should have a pH of approximately 5.5 or lower to avoid solubility problems that arise at pH 6 or higher.  $\text{Fe}^{3+}$  ions should be immobilized at low pH (approximately pH 3.0) to avoid formation of insoluble ferric compounds.

2. Wash the column with at least 2 column volumes of distilled water.
3. Apply at least 0.2 column volumes of the metal ion solution to the column.
4. Wash the column with at least 5 column volumes of distilled water to remove excess metal ions.

 Wash only with water, not buffer, prior to applying the metal ion solution, otherwise unwanted precipitation may occur.

 The column does not need to be stripped and recharged between each purification if the same protein is going to be purified. Reuse of any purification column depends on the nature of the sample and should only be performed with identical tagged proteins to prevent cross-contamination. For more information on this topic and on cleaning and storage, refer to Appendix 1.

 IMAC Sepharose High Performance is compatible with reducing agents. However, we recommend removal of any weakly bound metal ions before applying buffer/sample that includes reducing agents. This can be accomplished by performing a blank run without reducing agents (see below). Do not leave or store IMAC Sepharose High Performance with buffers that include reducing agents.

 Leakage of metal ions is low under all normal conditions. For critical applications, leakage during purification can be diminished by performing a blank run (as described on next page) before loading sample.


**Blank run:**

Use binding buffer and elution buffer without reducing agents.

1. Wash the column with 5 column volumes of distilled water (to remove the 20% ethanol).
2. Wash with 5 column volumes of elution buffer.
3. Equilibrate with 10 column volumes of binding buffer.

**Purification**

1. If necessary, wash out the 20% ethanol with 5 column volumes of distilled water. Use a flow velocity of 50 to 100 cm/h. Refer to Appendix 8 for flow rate calculations.
2. Equilibrate the column with 5 to 10 column volumes of binding buffer at a flow velocity of 150 cm/h.
3. Apply the pretreated sample.
4. Wash the column with binding buffer until the absorbance reaches the baseline.
5. Elute with elution buffer using a step or linear gradient. For step elution, 5 column volumes of elution buffer are usually sufficient. For linear gradient elution, a shallow gradient, over 20 column volumes, may separate proteins with similar binding strengths.
6. After elution, regenerate the column by washing it with 5 to 10 column volumes of binding buffer. The column is now ready for a new purification.

 For  $A_{280}$  measurements, use the elution buffers as blanks. If imidazole needs to be removed, use a desalting column (see Chapter 11). Low-quality imidazole will give a significant background absorbance at 280 nm.

## Purification using IMAC Sepharose 6 Fast Flow

IMAC Sepharose 6 Fast Flow consists of 90 µm beads of highly cross-linked agarose to which a chelating group has been covalently coupled. This chelating group will be charged with suitable metal ions by the user, allowing the medium to selectively retain target proteins.

IMAC Sepharose 6 Fast Flow displays a high protein binding capacity. The binding capacity is protein dependent and metal-ion dependent. The medium is easy to pack and use, and its high flow properties make it excellent for scaling up. See Appendix 1 for the main characteristics of IMAC Sepharose 6 Fast Flow. IMAC Sepharose 6 Fast Flow is supplied preswollen in 20% ethanol.

### Packing a column

See instructions supplied with the product, or refer to Appendix 6 for general guidelines for column packing.

### Sample preparation

This sample preparation procedure is applicable for all formats containing IMAC Sepharose 6 Fast Flow. See Cell lysis earlier in this chapter for a general description.

- Adjust the sample to the composition and pH of the binding buffer by adding buffer, NaCl, imidazole, and additives from concentrated stock solutions; by diluting the sample with binding buffer; or by buffer exchange. To prevent the binding of host cell proteins with exposed histidine, it is essential to include imidazole at a low concentration in the sample and binding buffer (see Chapter 4).
- Pass the sample through a 0.22 µm or a 0.45 µm filter and/or centrifuge it immediately before sample application. If the sample is too viscous, dilute it with binding buffer to prevent it from clogging; increase lysis treatment (sonication, homogenization); or add DNase/RNase to reduce the size of nucleic acid fragments.





**Fig 3.48.** IMAC Sepharose 6 Fast Flow provides high flow properties to enable scaled-up purification of histidine-tagged and native proteins. It provides numerous possibilities for optimizing purifications at both laboratory and process scale.



## Buffer preparation


Binding buffer: 20 mM sodium phosphate, 0.5 M NaCl, 20 to 40 mM imidazole, pH 7.4. (The optimal imidazole concentration is protein dependent; 20 to 40 mM is suitable for many proteins).

Elution buffer: 20 mM sodium phosphate, 0.5 M NaCl, 500 mM imidazole, pH 7.4.





-  Water and chemicals used for buffer preparation should be of high purity. Filter buffers through a 0.45 µm filter before use. Use high-purity imidazole, as this will give a very low or no absorbance at 280 nm.
-  The optimal concentration of imidazole needed in the sample and buffer to obtain the best purity and yield differs from protein to protein. In the binding buffer, 20 to 40 mM imidazole is suitable for many proteins; 500 mM imidazole in the elution buffer ensures complete elution of the target protein.

## Charging the chromatography medium with metal ion

1. Prepare a 0.1 M solution of the desired metal ion (e.g., Cu<sup>2+</sup>, Zn<sup>2+</sup>, Co<sup>2+</sup>, Fe<sup>3+</sup>, or Ni<sup>2+</sup>) in distilled water. Salts of chlorides, sulfates, etc., can be used (e.g., 0.1 M CuSO<sub>4</sub> or 0.1 M NiSO<sub>4</sub>).

-  Solutions of Zn<sup>2+</sup> ions should have a pH of approximately 5.5 or lower to avoid solubility problems that arise at pH 6 or higher. Fe<sup>3+</sup> ions should be immobilized at low pH (approximately pH 3.0) to avoid formation of insoluble ferric compounds.

2. Wash the column with at least 2 column volumes of distilled water.
3. Apply at least 0.2 column volumes of the metal ion solution to the column.
4. Wash the column with at least 5 column volumes of distilled water to remove excess metal ions.

-  Wash only with water, not buffer, prior to applying the metal ion solution, otherwise unwanted precipitation may occur.
-  The column does not need to be stripped and recharged between each purification if the same protein is going to be purified. Reuse of any purification column depends on the nature of the sample and should only be performed with identical tagged proteins to prevent cross-contamination. For more information on this topic and on cleaning and storage, refer to Appendix 1.
-  IMAC Sepharose 6 Fast Flow is compatible with reducing agents. However, we recommend removal of any weakly bound metal ions before applying buffer/sample that includes reducing agents. This can be accomplished by performing a blank run without reducing agents (see below). Do not leave or store IMAC Sepharose 6 Fast Flow with buffers that include reducing agents.
-  Leakage of metal ions is low under all normal conditions. For critical applications, leakage during purification can be diminished by performing a blank run (as described on next page) before loading sample.


### Blank run:

Use binding buffer and elution buffer **without** reducing agents.

1. Wash the column with 5 column volumes of distilled water (to remove the 20% ethanol).
2. Wash with 5 column volumes of elution buffer.
3. Equilibrate with 10 column volumes of binding buffer.

### Purification

1. If necessary, wash out the 20% ethanol with 5 column volumes of distilled water. Use a flow velocity of 50 to 100 cm/h. Refer to Appendix 8 for flow rate calculations.
2. Equilibrate the column with 5 to 10 column volumes of binding buffer at a flow velocity of 150 cm/h.
3. Apply the pretreated sample.
4. Wash the column with binding buffer until the absorbance reaches the baseline.
5. Elute with elution buffer using a step or linear gradient. For step elution, 5 column volumes of elution buffer are usually sufficient. For linear gradient elution, a shallow gradient, over 20 column volumes, may separate proteins with similar binding strengths.
6. After elution, regenerate the column by washing it with 5 to 10 column volumes of binding buffer. The column is now ready for a new purification.

 For  $A_{280}$  measurements, use the elution buffers as blanks. If imidazole needs to be removed, use a desalting column (see Chapter 11). Low-quality imidazole will give a significant background absorbance at 280 nm.

## Purification using HiTrap IMAC HP and HiTrap IMAC FF

HiTrap IMAC HP and HiTrap IMAC FF are 1 mL and 5 mL columns prepacked with IMAC Sepharose High Performance or IMAC Sepharose 6 Fast Flow, respectively. Sample application, washing, and elution can be performed using a syringe with a supplied adapter, a peristaltic pump, or a liquid chromatography system such as ÄKTA (see Chapter 2, Table 2.1 for equipment choices).

HiTrap IMAC HP and HiTrap IMAC FF columns are made of polypropylene, which is biocompatible and noninteractive with biomolecules. The top and bottom frits are manufactured from porous polyethylene. Columns are delivered with a stopper on the inlet and a snap-off end on the outlet. Each package includes all necessary components for connecting the columns to different types of equipment. For quick scale-up of purifications, two or three HiTrap columns (1 mL or 5 mL) can be connected in series (back pressure will be higher). Note that HiTrap IMAC columns cannot be opened or refilled.

### Sample and buffer preparation

Refer to *Purification using IMAC Sepharose High Performance* or *Purification using IMAC Sepharose 6 Fast Flow* for a general procedure for sample and buffer preparation, for HiTrap IMAC HP and HiTrap IMAC FF, respectively.




**Fig 3.49.** HiTrap IMAC HP 1 mL columns charged with Cu<sup>2+</sup>, Zn<sup>2+</sup>, Co<sup>2+</sup> and Ni<sup>2+</sup>, respectively.





## Charging the column with metal ion


1. Prepare a 0.1 M solution of the desired metal ion (e.g.,  $\text{Cu}^{2+}$ ,  $\text{Zn}^{2+}$ ,  $\text{Co}^{2+}$ ,  $\text{Fe}^{3+}$ , or  $\text{Ni}^{2+}$ ) in distilled water. Salts of chlorides, sulfates, etc., can be used (e.g., 0.1 M  $\text{CuSO}_4$  or 0.1 M  $\text{NiSO}_4$ ).


 Solutions of  $\text{Zn}^{2+}$  ions should have a pH of approximately 5.5 or lower to avoid solubility problems that arise at pH 6 or higher.  $\text{Fe}^{3+}$  ions should be immobilized at low pH (approximately pH 3.0) to avoid formation of insoluble ferric compounds.

2. Fill the pump tubing or syringe with distilled water. Remove the stopper and connect the column to the chromatography system tubing, syringe (use the connector supplied), or laboratory pump "drop to drop" to avoid introducing air into the system.
3. Remove the snap-off end at the column outlet.
4. Wash out the ethanol with 5 mL (HiTrap IMAC HP or FF 1 mL columns) or 15 mL (HiTrap IMAC HP or FF 5 mL columns) of distilled water. Do not use buffer to wash the column at this stage; a buffer wash may cause the metal ion to precipitate during step 5.
5. Charge the water-washed column by loading at least 0.5 mL (HiTrap IMAC HP or FF 1 mL columns) or 2.5 mL (HiTrap IMAC HP or FF 5 mL columns) of 0.1 M metal ion/salt solution.
6. Repeat the water wash described in step 4.
7. Equilibrate the column with at least 5 column volumes of binding buffer. Recommended flow rates are 1 mL/min or 5 mL/min for the 1 mL and 5 mL columns, respectively.

 Wash only with water, not buffer, prior to applying the metal ion solution, otherwise unwanted precipitation may occur.

 The column does not need to be stripped and recharged between each purification if the same protein is going to be purified. Reuse of any purification column depends on the nature of the sample and should only be performed with identical tagged proteins to prevent cross-contamination. For more information on this topic and on cleaning and storage, refer to Appendix 1.

 IMAC Sepharose is compatible with reducing agents. However, we recommend removal of any weakly bound metal ions before applying buffer/sample that includes reducing agents. This can be accomplished by performing a blank run without reducing agents (see next page). Do not leave or store HiTrap IMAC columns with buffers that include reducing agents.

 For critical applications, leakage of metal ions during purification can be diminished by performing a blank run (as described on the next page) before loading sample.

### Blank run:


Use binding buffer and elution buffer **without** reducing agents.

1. Wash the column with 5 column volumes of distilled water (to remove the 20% ethanol).
2. Wash with 5 column volumes of elution buffer.
3. Equilibrate with 10 column volumes of binding buffer.

### Purification

1. Apply the pretreated sample using a syringe fitted to the connector or by pumping it onto the column. For best results, use a flow rate of 0.2 to 1 mL/min (1 mL column) and 0.5 to 5 mL/min (5 mL column) during sample application<sup>1</sup>.
2. Wash with binding buffer (generally at least 10 to 15 column volumes) until the absorbance reaches a steady baseline.
3. Elute with elution buffer using a one-step or linear gradient. For step elution, 5 column volumes usually suffice. A linear gradient over 20 column volumes or more may separate proteins with similar binding strengths.
4. After elution, regenerate the column by washing it with 5 to 10 column volumes of binding buffer. The column is now ready for a new purification.

<sup>1</sup> One mL/min corresponds to approximately 30 drops/min when using a syringe with a HiTrap 1 mL column, and 5 mL/min corresponds to approximately 120 drops/min when using a HiTrap 5 mL column.

 The column does not need to be stripped and recharged between each purification if the same protein is going to be purified. Reuse of any purification column depends on the nature of the sample and should only be performed with identical tagged proteins to prevent cross-contamination. For more information on this topic and on cleaning and storage, refer to Appendix 1.

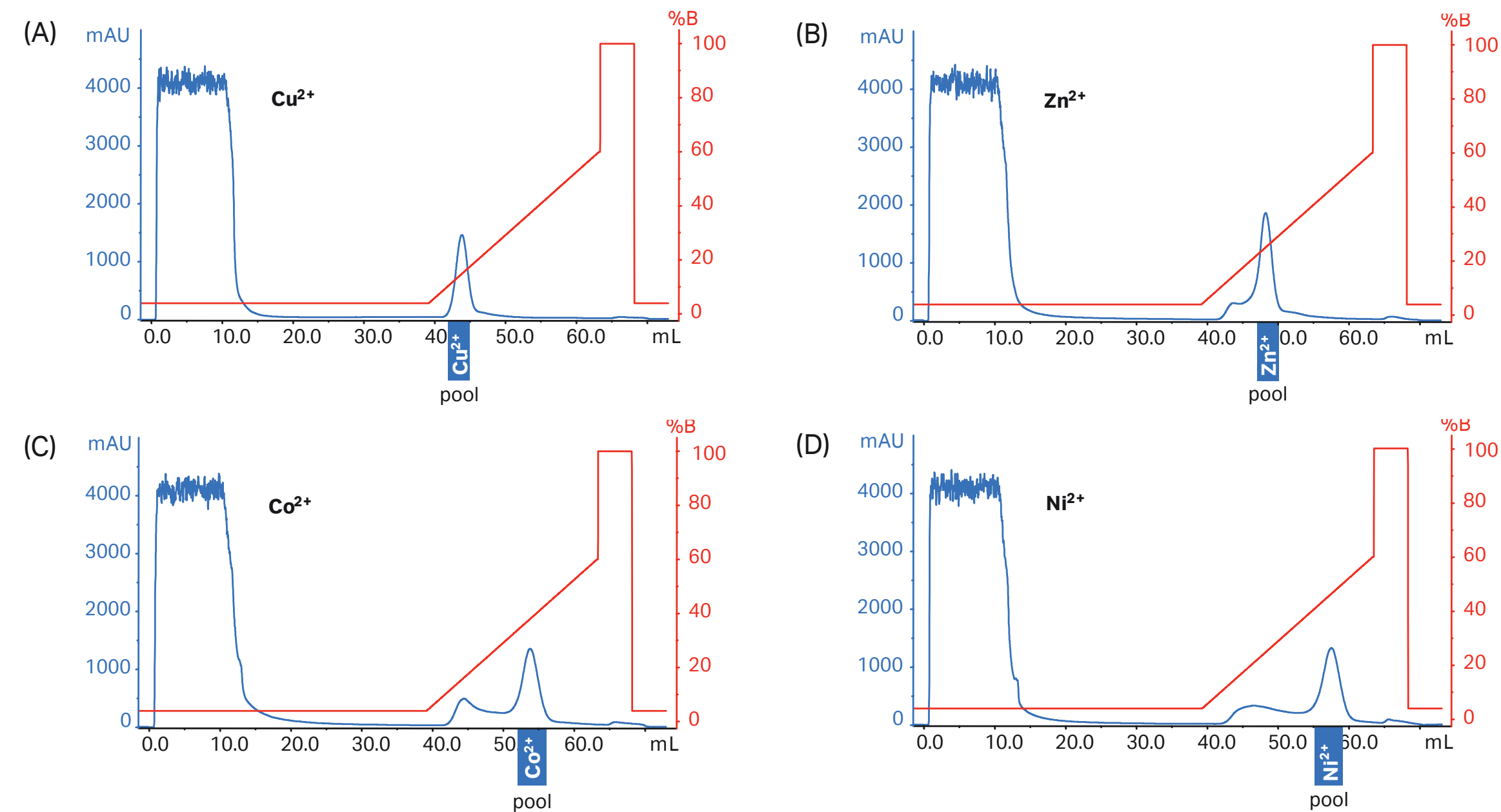
## Application example

### Purification screening using different metal ions

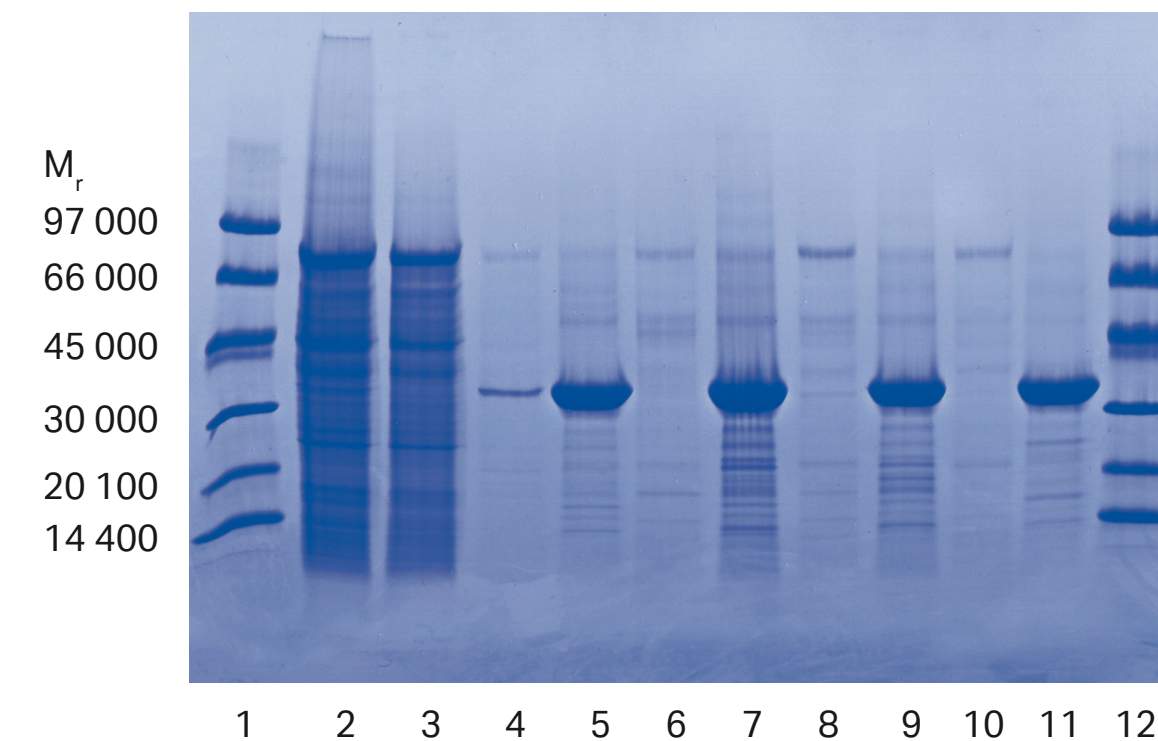
YNR064c ( $M_r$  33 700) is a (histidine)<sub>6</sub>-tagged protein expressed in *Pichia pastoris*. It was purified using HiTrap IMAC HP 1 mL columns charged separately with Cu<sup>2+</sup>, Zn<sup>2+</sup>, Co<sup>2+</sup>, or Ni<sup>2+</sup>; conditions were otherwise the same for the four purifications. See Figures 3.50A–E for the resulting chromatograms and SDS-PAGE analysis of pooled fractions.

The results show that for this (histidine)<sub>6</sub>-tagged target protein, the highest purity was achieved with Ni<sup>2+</sup> or Cu<sup>2+</sup>, although Cu<sup>2+</sup>, at the conditions used, apparently gave a small loss of target protein (Figure 3.50E, lane 4).

<b>Column:</b>	HiTrap IMAC HP 1 mL, charged with: A) Cu <sup>2+</sup> B) Zn <sup>2+</sup> C) Co <sup>2+</sup> D) Ni <sup>2+</sup> Conditions were otherwise the same for the four purifications
<b>Sample:</b>	Histidine-tagged YNR064c ( $M_r$ 33 700) in clarified <i>Pichia pastoris</i> extract including 20 mM imidazole
<b>Sample volume:</b>	10 mL
<b>Binding buffer:</b>	20 mM sodium phosphate, 500 mM NaCl, 20 mM imidazole, pH 7.4
<b>Elution buffer:</b>	20 mM sodium phosphate, 500 mM NaCl, 500 mM imidazole, pH 7.4
<b>Flow rate:</b>	1 mL/min
<b>Gradient:</b>	4%–60% elution buffer (20–300 mM imidazole) in 25 mL; 100% elution buffer (500 mM imidazole) in 5 mL
<b>Detection:</b>	Absorbance, 280 nm
<b>System:</b>	ÄKTA



(E)



#### Lanes

1. LMW markers
2. Start material, diluted 1:10
3. Flowthrough, diluted 1:10, Cu<sup>2+</sup>
4. Wash, Cu<sup>2+</sup>
5. Eluted pool, Cu<sup>2+</sup>
6. Wash, Zn<sup>2+</sup>
7. Eluted pool, Zn<sup>2+</sup>
8. Wash, Co<sup>2+</sup>
9. Eluted pool, Co<sup>2+</sup>
10. Wash, Ni<sup>2+</sup>
11. Eluted pool, Ni<sup>2+</sup>
12. LMW markers

**Fig 3.50.** Purification of (histidine)<sub>6</sub>-tagged YNR064c expressed in *Pichia pastoris* on four different HiTrap IMAC HP 1 mL columns charged separately with metal ions (A) Cu<sup>2+</sup>, (B) Zn<sup>2+</sup>, (C) Co<sup>2+</sup>, or (D) Ni<sup>2+</sup>. Pools selected after SDS-PAGE of individual 1 mL fractions (not shown) are indicated. (E) SDS-PAGE analysis: reducing conditions on ExcelGel SDS Gradient 8–18; Coomassie staining.



## Condition screening for scaling up using HiScreen IMAC FF

HiScreen IMAC FF is a ready-to-use column for purification of proteins by IMAC. The column is prepacked with 4.7 mL of uncharged IMAC Sepharose 6 Fast Flow. The high flow rate properties of this chromatography medium make HiScreen IMAC FF columns well suited for establishing optimal chromatographic conditions for scaling up as well as for small-scale purifications.

The medium can easily be charged with  $\text{Ni}^{2+}$ ,  $\text{Co}^{2+}$ ,  $\text{Zn}^{2+}$ ,  $\text{Cu}^{2+}$ ,  $\text{Fe}^{3+}$  or other metal ions. The columns are made of biocompatible polypropylene that does not interact with biomolecules. See Appendix 1 for the main characteristics of HiScreen IMAC FF.


The columns are used in an optimal manner with liquid chromatography systems such as ÄKTA.

### Sample and buffer preparation

Refer to *Purification using IMAC Sepharose 6 Fast Flow* for a general procedure for sample and buffer preparation.

### Charging the chromatography medium with metal ions




1. Prepare a 0.1 M solution of the desired metal ion (e.g.,  $\text{Cu}^{2+}$ ,  $\text{Zn}^{2+}$ ,  $\text{Co}^{2+}$ ,  $\text{Fe}^{3+}$ , or  $\text{Ni}^{2+}$ ) in distilled water. Salts of chlorides, sulfates, etc., can be used (e.g., 0.1 M  $\text{CuSO}_4$  or 0.1 M  $\text{NiSO}_4$ ).

 Solutions of  $\text{Zn}^{2+}$  ions should have a pH of approximately 5.5 or lower to avoid solubility problems that arise at pH 6 or higher.  $\text{Fe}^{3+}$  ions should be immobilized at low pH (approximately pH 3.0) to avoid formation of insoluble ferric compounds.

2. Wash the column with 25 mL of distilled water.
3. Apply at least 2.5 mL of the metal ion solution to the column.
4. Wash with 25 mL of distilled water and 25 mL of binding buffer (washing with binding buffer — to adjust pH — should be done even if the metal-charged column is only to be stored in 20% ethanol).



**Fig 3.51.** HiScreen IMAC FF column for establishing optimal chromatographic conditions for scaling up.

-  Wash only with water, not buffer, prior to applying the metal ion solution, otherwise unwanted precipitation may occur.
-  In some cases, a blank run may be needed (see next page).
-  The column does not have to be stripped and recharged between each purification if the same protein is going to be purified; it may be sufficient to strip and recharge it after approximately five purifications, depending on the sample properties, sample volumes, metal ion, etc.

### Optional blank run:

Perform a blank run without reducing agents before applying buffers/samples containing reducing agents. Likewise, a blank run is recommended for critical purifications where metal ion leakage during purification must be minimized.

Use binding buffer and elution buffer **without** reducing agents.

1. If the column has been stored in 20% ethanol after metal ion charging, wash it with 25 mL of distilled water.
2. Wash with 25 mL of the buffer that has been chosen for protein elution, for example, imidazole elution buffer or low-pH elution buffer.
3. Equilibrate with 25 to 50 mL of binding buffer. Imidazole equilibration can be monitored by absorbance, e.g., at 220 nm.

### Purification


The recommended flow rate for HiScreen IMAC FF is 2.3 mL/min (300 cm/h flow velocity).


1. After the column preparation (charging with metal ions), equilibrate with at least 5 column volumes of binding buffer. Avoid introducing air into the column.

 To prevent leakage, ensure that the connectors are tight. Use fingertight 1/16" connector (see *Ordering information*).

 In some cases, we recommend a blank run before final equilibration/sample application (see above).

2. Adjust the sample to the chosen starting conditions and load on the column.
3. Wash with 5 to 10 column volumes of binding buffer until the UV trace of the effluent returns to near baseline.
4. Elute either by linear gradient elution or step elution at recommended flow rates. If required, the collected eluted fractions can be buffer exchanged or desalted.
  - Linear gradient elution: Elute with 0% to 100% elution buffer (up to 500 mM imidazole) in 10 to 20 column volumes.
  - Step elution: Elute with 5 column volumes of elution buffer including imidazole at chosen concentration. Repeat at higher imidazole concentrations until the target protein has been eluted.
5. If required, strip the column from metal ions and perform CIP to clean the column.
6. Re-equilibrate the column with 5 to 10 column volumes of binding buffer or until the UV baseline, eluent pH, and conductivity reach the required values.

 Do not exceed the maximum recommended flow and/or back pressure for the column.

 For  $A_{280}$  measurements, use the elution buffers as blanks. If imidazole needs to be removed, use a desalting column (see Chapter 11). Low-quality imidazole will give a significant background absorbance at 280 nm.

## Preparative purification using HiPrep IMAC FF 16/10

HiPrep IMAC FF 16/10 is a ready-to-use 20 mL column, prepacked with uncharged IMAC Sepharose 6 Fast Flow. The column is well-suited for preparative purification of histidine-tagged recombinant proteins and untagged, naturally occurring proteins. HiPrep IMAC FF 16/10 provides fast, simple, and easy separations in a convenient format, and the IMAC Sepharose 6 Fast Flow medium is well-suited for scaling up.

The column is made of polypropylene, which is biocompatible and noninteractive with biomolecules. Separations can be easily achieved using a chromatography system such as ÄKTA. Refer to Chapter 2, Table 2.1 for a selection guide to purification equipment and to Appendix 1 for a list of HiPrep IMAC FF 16/10 column parameters.

IMAC Sepharose 6 Fast Flow is also available as prepacked 1 mL and 5 mL HiTrap IMAC FF columns and as a bulk medium in lab packs (25 and 100 mL) for packing columns.

### Sample and buffer preparation

Refer to *Purification using IMAC Sepharose 6 Fast Flow* for a general procedure for sample and buffer preparation.

### Charging the column with metal ion

1. Prepare a 0.1 M solution of the desired metal ion (e.g.,  $\text{Cu}^{2+}$ ,  $\text{Zn}^{2+}$ ,  $\text{Co}^{2+}$ ,  $\text{Fe}^{3+}$ , or  $\text{Ni}^{2+}$ ) in distilled water. Salts of chlorides, sulfates, etc., can be used (e.g., 0.1 M  $\text{CuSO}_4$  or 0.1 M  $\text{NiSO}_4$ ).

☞ Solutions of  $\text{Zn}^{2+}$  ions should have a pH of approximately 5.5 or lower to avoid solubility problems that arise at pH 6 or higher.  $\text{Fe}^{3+}$  ions should be immobilized at low pH (approximately pH 3.0) to avoid formation of insoluble ferric compounds.

2. Wash the column with at least 2 column volumes of distilled water.
3. Apply at least 0.2 column volumes of the metal ion solution to the column.
4. Wash the column with at least 5 column volumes of distilled water to remove excess metal ions.

☞ Washing with buffer before applying the metal ion solution may cause unwanted precipitation.







Fig 3.52. Prepacked 20 mL HiPrep IMAC FF 16/10 columns allow for easy scale-up.



## Purification

1. Apply the centrifuged and/or filtered sample (in binding buffer) to the column at a flow rate of 1 to 10 mL/min (30 to 300 cm/h).
2. Wash the column with 5 to 10 column volumes of binding buffer at 2 to 10 mL/min (60 to 300 cm/h).
3. Elute the bound protein with 5 to 10 column volumes of elution buffer at a flow rate of 2 to 10 mL/min (60 to 300 cm/h).
4. After elution, regenerate the column by washing it with 5 to 10 column volumes of binding buffer. The column is now ready for a new purification.

-  The column does not need to be stripped and recharged between each purification if the same protein is going to be purified. Reuse of any purification column depends on the nature of the sample and should only be performed with identical tagged proteins to prevent cross-contamination. For more information on this topic and on cleaning and storage, refer to Appendix 1.
-  IMAC Sepharose 6 Fast Flow is compatible with reducing agents. However, we recommend removal of any weakly bound metal ions before applying buffer/sample that includes reducing agents. This can be accomplished by performing a blank run without reducing agents (see right). Do not leave or store HiPrep IMAC FF 16/10 columns with buffers that include reducing agents.
-  For critical applications, leakage of metal ions during purification can be diminished by performing a blank run (as described to the right) before loading sample.
-  For  $A_{280}$  measurements, use the elution buffers as blanks. If imidazole needs to be removed, use a desalting column (see Chapter 11). Low-quality imidazole will give a significant background absorbance at 280 nm.

## Blank run:

Use binding buffer and elution buffer **without** reducing agents.


1. Wash the column with 5 column volumes of distilled water (to remove the 20% ethanol).
2. Wash with 5 column volumes of elution buffer.
3. Equilibrate with 10 column volumes of binding buffer.


## Detection of histidine-tagged proteins

Table 3.4 reviews the methods available for detection of histidine-tagged proteins. These methods can be selected according to the experimental situation. For example, SDS-PAGE analysis, performed frequently during expression and purification to monitor results, may not be the method of choice for routine monitoring of samples from high-throughput screening. Functional assays specific for the protein of interest are useful but not often available.

## Tag removal by enzymatic cleavage

In most cases, functional tests can be performed using the intact histidine-tagged protein. If removal of the tag is necessary, then procedures similar to GST tag removal can be followed, that is, specific recognition sites are incorporated to allow subsequent enzymatic cleavage. The precise protocols required for cleavage and purification will depend on the original vectors and the properties of the specific enzymes used for cleavage.


 rTEV protease (Invitrogen) has a (histidine)<sub>6</sub>-tag and recognizes the amino acid sequence Glu-Asn-Leu-Tyr-Phe-Gln↓Gly. Glu, Tyr, Gln and Gly are needed for cleavage between the Gln and Gly residues (↓). N-terminal (histidine)<sub>6</sub>-tags can be removed. The advantage of this enzymatic cleavage is that the protein of interest can be repurified using the same Ni Sepharose medium or prepacked column. The (histidine)<sub>6</sub>-tag and the (histidine)<sub>6</sub>-tag rTEV protease will both bind to the column, and the protein of interest can be collected in the flowthrough.

 The amount of enzyme, temperature, and length of incubation required for complete digestion vary according to the specific tagged protein produced. Determine optimal conditions in preliminary experiments. Remove samples at various time points and analyze by SDS-PAGE to estimate the yield, purity, and extent of digestion. Approximate molecular weights for SDS-PAGE analysis:

rTEV protease                    M<sub>r</sub> 29 000

Carboxypeptidase A<sup>1</sup>        M<sub>r</sub> 94 000

<sup>1</sup> for the removal of C-terminal (histidine)<sub>6</sub>-tags.

 Some cleavage procedures will require a second purification step to remove the protease or other contaminants. Conventional chromatographic separation techniques such as SEC (usually no need for optimization), IEX, or HIC will need to be developed (see Appendix 11).

**Table 3.4.** Detection methods for histidine-tagged proteins

Generic detection method (detects the tag)	Comments
ELISA assay using anti-His antibody	Highly specific, detects only histidine-tagged protein.
Western blot or dot blot analysis using anti-His antibody and ECL detection systems <sup>1</sup>	Highly specific, detects only histidine-tagged protein. Little or no background when used at optimized concentrations with secondary HRP-conjugated antibody.  Amersham ECL is a chemiluminescent detection reagent providing adequate sensitivity for most recombinant expression applications. For higher sensitivity use Amersham ECL Prime or Amersham ECL Select™ (chemiluminescence), alternatively Amersham ECL Plex™ (fluorescence).
Biacore™ analysis using His antibody or nitrilotriacetic acid (NTA) surface	Highly specific, detects only histidine-tagged protein. Can also assess activity of the histidine-tagged protein.
Detection methods specific for the target protein	
SDS-PAGE with Coomassie or silver staining <sup>1</sup>	Provides information on size and % purity. Detects tagged protein and contaminants.
Biacore analysis using receptor or ligand to the histidine-tagged protein	Provides information on concentration and activity without the need for standard curves.
Functional assays	Useful to assess if the purified histidine-tagged protein is active. Not always available. May require development and optimization.

<sup>1</sup> See *Western Blotting: Principles and Methods*, 28999897.

## Application example

### Automatic histidine tag removal using ÄKTExpress

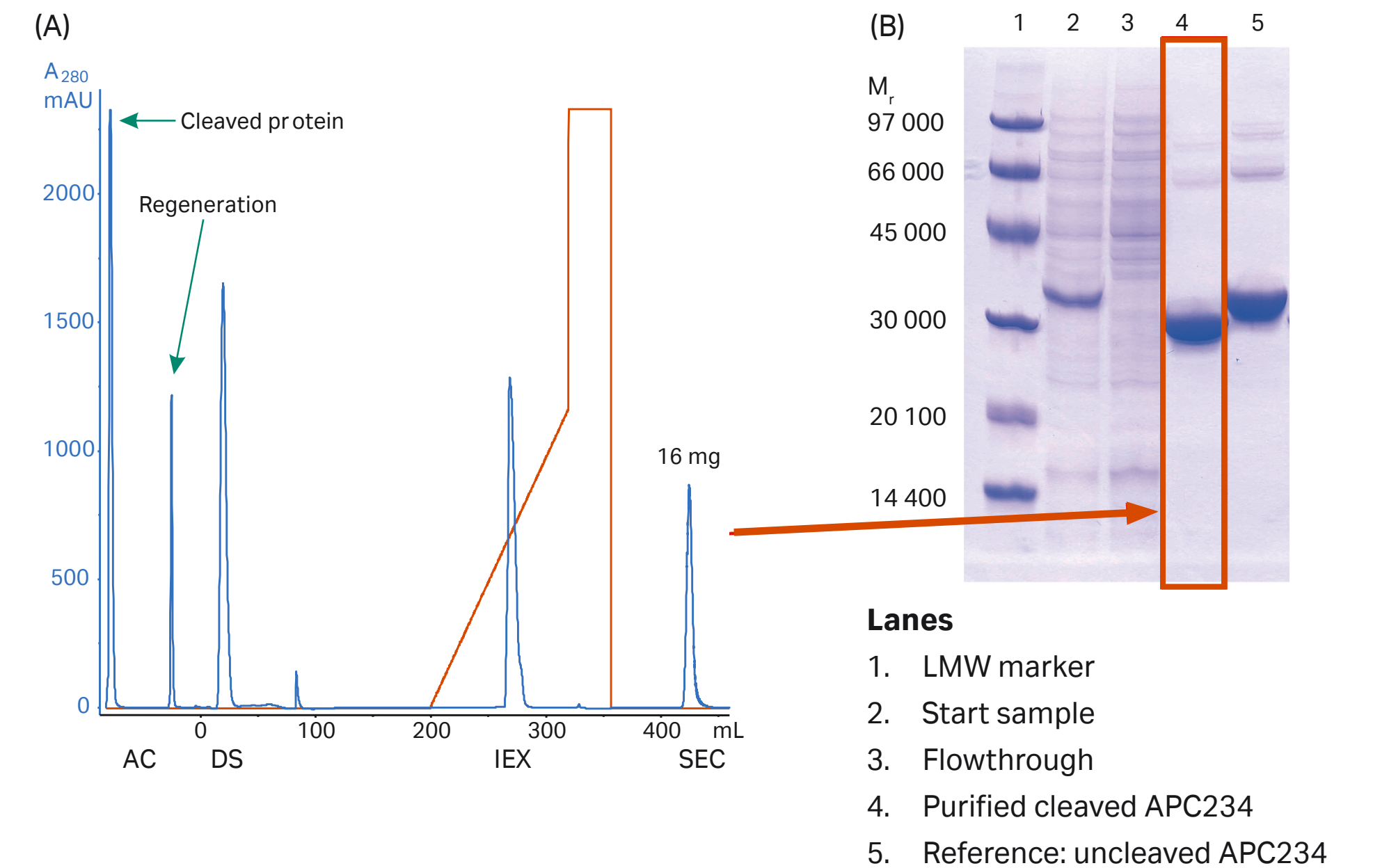
On the following page we present an example of automated tag removal using ÄKTExpress. All multistep purification protocols in ÄKTExpress can be combined with automated on-column tag cleavage. Tag cleavage is always performed on the affinity column prior to further purification steps. When the cleaved protein has been eluted, the affinity column is regenerated and affinity tag, tagged protease, and remaining uncleaved protein are collected in a separate outlet. The procedure involves binding the tagged protein, injection of protease, incubation, elution of cleaved protein, and collection in capillary loop(s), followed by further purification steps.

### Four-step protocol: (histidine)<sub>6</sub>-tagged protein cleaved with AcTEV™ protease

The example in Figure 3.53 shows purification results for a (histidine)<sub>6</sub>-tagged protein, APC234 ( $M_r$  32 500), expressed in *E. coli*. The  $M_r$  of the cleaved product is 30 000. After harvest, cell lysis was performed by sonication. The samples were clarified by centrifugation prior to sample loading.

AC, DS, IEX, and SEC were all performed on ÄKTExpress using columns as indicated in the figure. The purity of each sample was analyzed by SDS-PAGE (Coomassie staining). The reduced samples were applied on an SDS-polyacrylamide gel. Approximately 7.5  $\mu$ g of protein was loaded per lane.

<b>Columns:</b>	AC: HisTrap HP, 5 mL
	DS: HiPrep 26/10 Desalting
	IEX: RESOURCE™ Q, 6 mL
	SEC: HiLoad 16/60 Superdex 75 pg
<b>Sample:</b>	APC234, $M_r$ 32 000 (cleaved product, $M_r$ 30 000)
<b>Cleavage conditions:</b>	200 units of AcTEV protease/mg protein, 8 h incubation time at room temperature
<b>AC binding buffer:</b>	50 mM Tris-HCl, 500 mM NaCl, 20 mM imidazole, pH 7.5
<b>AC cleavage buffer:</b>	50 mM Tris-HCl, 500 mM NaCl, 50 mM imidazole, pH 7.5
<b>AC elution buffer:</b>	50 mM Tris-HCl, 500 mM NaCl, 500 mM imidazole, pH 7.5
<b>DS and IEX binding buffer:</b>	50 mM Tris-HCl, pH 8.0
<b>IEX elution buffer:</b>	50 mM Tris-HCl, 1 M NaCl, pH 8.0
<b>SEC buffer:</b>	50 mM Tris-HCl, 150 mM NaCl, pH 7.5



**Fig 3.53.** (A) Four-step protocol for purification of (histidine)<sub>6</sub>-tagged protein cleaved with AcTEV protease. (B) SDS-PAGE analysis. The gel was stained with Coomassie.



## Troubleshooting

The troubleshooting guide below addresses problems common to the majority of purification products discussed in this chapter, as well as problems specific to a particular method. In the latter case, the relevant product is indicated.

For more product-specific troubleshooting, refer to the instructions supplied with the product.

Problem	Possible cause	Solution
Column or plate wells have clogged.  OR  Liquid has not been completely removed during centrifugation (SpinTrap columns).  OR  Flow rate is too slow (GraviTrap columns).	Cell debris is present.         The sample is too viscous due to too high a concentration of material or the presence of large nucleic acid molecules (may be evidenced by increased back pressure).         Protein is difficult to dissolve or precipitates during purification.	Optimize sample pretreatment before the next sample loading.  Centrifuge and/or pass the sample through a 0.22 or 0.45 µm filter. Clean the chromatography medium according to Appendix 1. If cleaning-in-place (CIP) is unsuccessful, replace the medium/prepacked column. Try using a HisTrap FF crude column or a HiTrap TALON crude column.    Increase the efficiency of the mechanical cell disruption (e.g., increase sonication time). Keep the sample on ice to avoid frothing and overheating because this may denature the target protein.  Increase dilution of the cell paste before lysis, or dilute after lysis to reduce viscosity.  If the lysate is very viscous due to a high concentration of host nucleic acid, continue cell disruption until the viscosity is reduced, and/or add an additional dose of DNase and Mg <sup>2+</sup> (DNase 1 to 5 µg/mL, Mg <sup>2+</sup> to 1 mM), and incubate on ice for 10 to 15 min. Alternatively, draw the lysate through a syringe needle several times.  Freeze/thaw of the unclarified lysate may increase precipitation and aggregation. Mechanical lysis of the thawed lysate can prevent increased back-pressure problems when loading the column.  If the purification has been performed at 4°C, move to room temperature if possible (sample viscosity is reduced at room temperature).  Decrease the flow rate during sample loading.  First, screen for suitable conditions for solubility; vary pH, ionic strength, protein concentration, detergent, or other additives that may affect solubility of the protein.  The following additives may be used: up to 1% NP-40, 1% CHAPS, 1.0 M NaCl, 20% glycerol, 10 mM β-mercaptoethanol, 1 to 3 mM DTT or DTE (up to 5 mM is possible but depends on the sample and the sample volume). Mix gently for 30 min to aid solubilization of the tagged protein. Note that NP-40 (but not Tween™-20 up to 1% concentration) have a high absorbance at 280 nm. Furthermore, detergents cannot be easily removed by buffer exchange.  Inclusion bodies: the protein can usually be solubilized (and unfolded using common denaturants such as 4 to 6 M Gua-HCl, 4 to 8 M urea, or strong detergents. See Chapter 10, <i>Handling of inclusion bodies</i> .

continues on following page

<b>Problem</b>	<b>Possible cause</b>	<b>Solution</b>
There is no or low yield of histidine-tagged protein in the purified fractions.	No histidine-tagged protein present in the starting material.	Verify presence of histidine-tagged protein in the starting material, e.g., by Western blotting.
	Nickel ions are being stripped.	Change to Ni Sepharose excel if the sample causes stripping, for example, if the histidine-tagged proteins are secreted into eukaryotic cell culture supernatants.
		Ni Sepharose excel, HisTrap excel, and His Mag Sepharose excel have exceptionally strongly bound nickel ions.
	Elution conditions are too mild (histidine-tagged protein still bound).	Elute with increasing imidazole concentration or decreasing pH.
	Protein has precipitated in the column or wells.	Decrease amount of sample, or decrease protein concentration by eluting with linear imidazole gradient instead of imidazole steps. Try detergents or change NaCl concentration.
	Nonspecific hydrophobic or other interactions are occurring.	Add a nonionic detergent to the elution buffer (e.g., 0.2% Tween-20) or change the NaCl concentration.
Histidine-tagged protein is eluted during sample loading/wash.	Low yield of eluted protein when loading a highly unclarified sample.	Clarify the sample before loading on columns or in wells. High levels of host proteins and other particles may interfere with the binding of the target protein. Consider using a HisTrap FF crude column or a HiTrap TALON crude column.
	Histidine-tagged protein is not completely eluted.	Elute with a larger volume of elution buffer and/or increase the concentration of imidazole.
	The concentration of imidazole in the sample and/or binding buffer is too high.	Lower the imidazole concentration. Note that imidazole is usually not required in sample and binding buffer for TALON Superflow and Ni Sepharose excel.
	The histidine tag may be insufficiently exposed.	Perform purification of unfolded protein in urea or Gua-HCl as for inclusion bodies to investigate if the tag is hidden. To minimize dilution of the sample, solid urea or Gua-HCl can be added. Consider a His-10-tag or add a linker between the tag and the target protein to increase exposure.
	Buffer/sample composition is not optimal.	Check pH and composition of sample and binding buffer. Ensure that chelating or strong reducing agents are not present in the sample at too high concentration.  Increase the buffering capacity of the wash and elution buffer to avoid a drop in pH caused by imidazole.
	Histidine tag has been lost.	Check sequence of the construct on a Western blot or extract using anti-His antibody.
	Incubation time is too short.	Decrease the flow rate or increase the incubation time of the sample in the wells/batch or use a lower centrifugation speed/vacuum (SpinTrap and MultiTrap columns).
	Contaminants may have a high affinity for certain metal ions.	For applicable formats (i.e., prepacked HisTrap columns), join two or three columns together or change to a larger column.
	Capacity is exceeded.	For applicable formats (i.e., prepacked HisTrap columns), join two or three columns together or change to a larger column.

*continues on following page*

Problem	Possible cause	Solution
Histidine-tagged protein is found in the pellet.	Sonication may be insufficient.	Cell disruption may be checked by microscopic examination or monitored by measuring the release of nucleic acids at $A_{260}$ . Addition of lysozyme (up to 0.1 volume of a 10 mg/mL lysozyme solution in 25 mM Tris-HCl, pH 8.0) prior to sonication may improve results. Avoid frothing and overheating because this may denature the target protein.
	Protein was adsorbed to cell debris during extraction and lost upon clarification.	Change extraction conditions (pH, ionic strength, try detergent solubilization).
	The protein may be insoluble (inclusion bodies).	The protein can usually be solubilized (and unfolded) from inclusion bodies using common denaturants such as 4 to 6 M Gua-HCl, 4 to 8 M urea, or strong detergents. See Chapter 10, <i>Handling inclusion bodies</i> .
The eluted protein is not pure (multiple bands on SDS-PAGE).	Proteases have partially degraded the tagged protein.	Add protease inhibitors (use EDTA with caution).
	<i>In vivo</i> anomalies of protein biosynthesis, e.g., premature termination of translation.	Change fermentation and induction conditions. Consider changing host strain or host to overcome problems with codon bias.
	Contaminants have high affinity for the metal ion.	Elute with a stepwise or linear imidazole gradient. Wash before elution with binding buffer containing as high a concentration of imidazole as possible, without causing elution of the tagged protein. Try TALON Superflow for high purity or test using another metal ion on IMAC Sepharose. A second chromatography step such as SEC may be necessary.
	Contaminants are associated with tagged protein, e.g., chaperone attached to the target protein.	Add detergent and/or reducing agents before sonicating cells. Increase detergent levels (e.g., up to 2% Tween 20), or add glycerol (up to 20%) to the wash buffer to disrupt nonspecific interactions. Increase the imidazole concentration or change the metal ion used for purification. Increase the sodium chloride concentration up to 500 mM in buffers.
	Unbound material has been insufficiently removed by the washing step.	Repeat the wash step after sample application to obtain optimal yield and purity.
	Unwanted air bubbles have formed when using a chromatography system.	Unclarified lysates may cause increased air bubble formation during purification.
MultiTrap: Leakage of solution is observed after removing foils.		Add 500 $\mu$ L of deionized water twice before adding binding buffer to the wells. Remove the solution between the additions with either centrifugation or vacuum.



04

# Optimizing purification of histidine-tagged proteins

Three methods for optimizing purification of histidine-tagged proteins to achieve high purity are discussed in this chapter:


- Optimizing using imidazole
- Optimizing using different metal ions
- Optimizing using multistep purifications

For general purification of histidine-tagged proteins, including typical workflow, descriptions of available chromatography media and product formats, procedures, and troubleshooting hints, refer to Chapter 3.

## Optimizing using imidazole

The presence of surface-exposed histidine residues or other complex-forming amino acids can lead to unwanted binding of untagged host cell proteins to purification media. These untagged proteins may elute with the target protein. The binding affinity of these contaminants is often lower than that of the tagged recombinant proteins; therefore, it may be possible to remove them by optimizing the separation conditions.

The examples below show how changes in imidazole concentration during binding affect the purity of the histidine-tagged target protein.

 When using Ni Sepharose excel and TALON Superflow products it is usually not recommended to include imidazole during binding.

### 1. Imidazole as a competitive agent

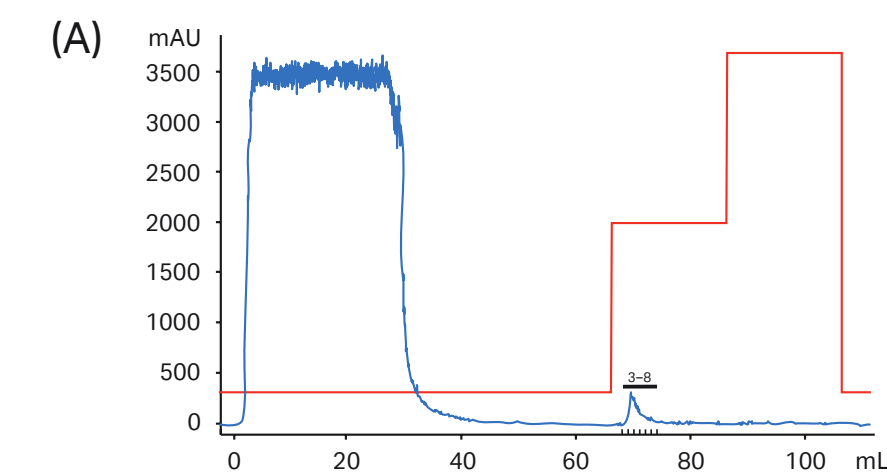
Imidazole is utilized as a competitive agent for elution of histidine-tagged proteins. In addition, imidazole can be added in low concentrations in the sample and binding buffer in order to reduce the binding of contaminant proteins, and thus increase the final purity.

Histidine-tagged protein kinase G [(His)<sub>6</sub>-PknG] from *Mycobacterium bovis* was purified using a concentration of 45 mM imidazole in the sample and binding buffer. The medium used in the experiment was Ni Sepharose High Performance (see Chapter 3).

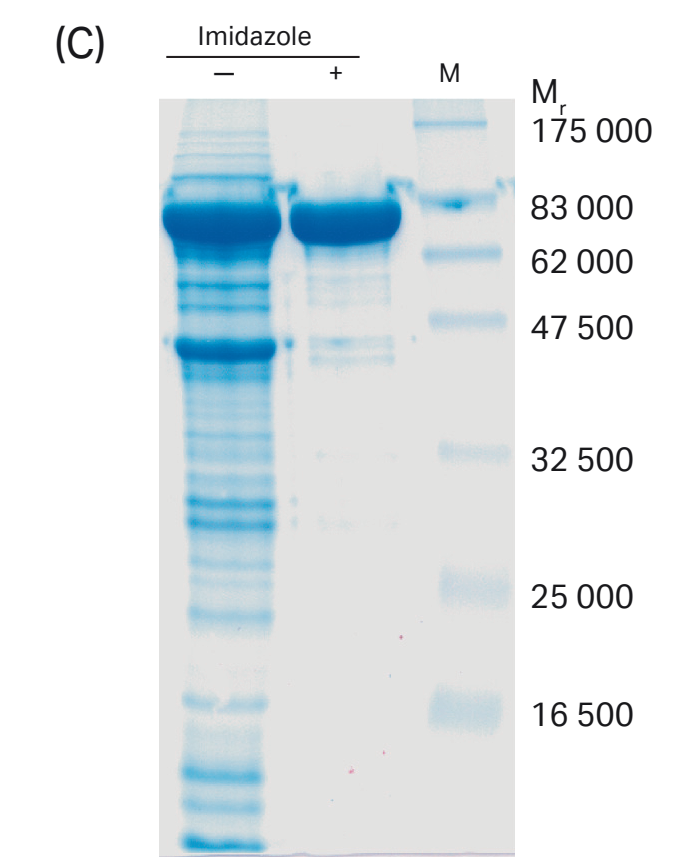
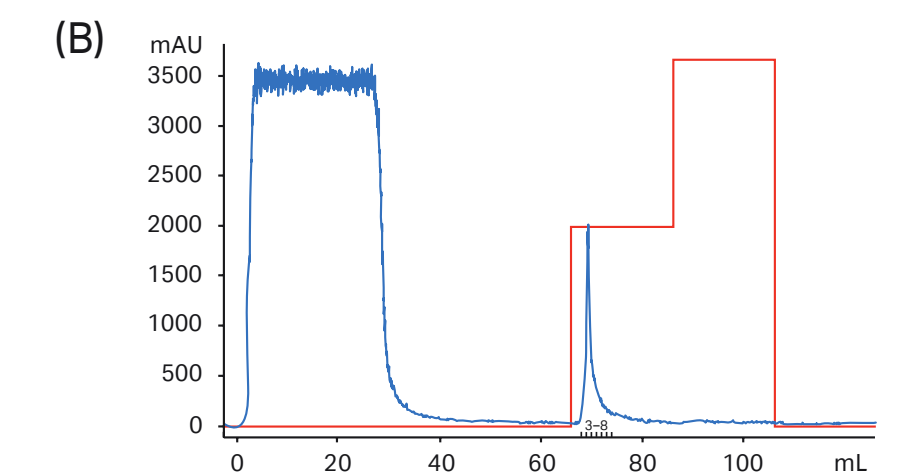
To achieve a higher protein concentration, the protein was eluted in a step gradient (Fig 4.1A). To demonstrate the advantageous effect of imidazole during binding, an additional purification was performed under the same conditions except that imidazole was omitted (Fig 4.1B). It is important to note that omission of imidazole is not generally recommended for Ni Sepharose High Performance or Ni Sepharose 6 Fast Flow; this example is provided solely to demonstrate the negative effect of its absence on the purity of the eluted target protein.

SDS-PAGE of the pooled elution fractions indicated a large improvement in purity of the target protein when 45 mM imidazole was included in the sample and binding buffer (Fig 4.1C). The yield of the target protein was in this case maintained in the sample with 45 mM imidazole present. Note that the optimal concentration of imidazole is protein dependent and thus must be determined case by case.

Column: Ni Sepharose High Performance, 2 mL in XK 16/20  
 Sample: Histidine-tagged PknG in 26 mL *E. coli* M15 extract  
 Binding buffer: 20 mM Tris, pH 8.0, 0.5 M NaCl, 1% Triton X-100, 10% glycerol, 10 mM β-mercaptoethanol  
 Elution buffer: 20 mM Tris, pH 8.0, 0.5 M NaCl, 1% Triton X-100, 10% glycerol, 10 mM β-mercaptoethanol, 500 mM imidazole  
 Gradient: 2-step  
 50% elution buffer, 20 CV; 100% elution buffer, 20 CV  
 Flow rate: 1 mL/min  
 System: ÄKTA system



Column: Ni Sepharose High Performance, 2 mL in XK 16/20  
 Sample: Histidine-tagged PknG in 26 mL *E. coli* M15 extract  
 Binding buffer: 20 mM Tris, pH 8.0, 0.5 M NaCl, 1% Triton X-100, 10% glycerol, 10 mM β-mercaptoethanol, 45 mM imidazole  
 Elution buffer: 20 mM Tris, pH 8.0, 0.5 M NaCl, 1% Triton X-100, 10% glycerol, 10 mM β-mercaptoethanol, 500 mM imidazole  
 Gradient: 2-step  
 50% elution buffer, 20 CV; 100% elution buffer, 20 CV  
 Flow rate: 1 mL/min  
 System: ÄKTA system



**Fig 4.1.** Purification of (His)<sub>6</sub>-PknG without (A) and with (B) 45 mM imidazole in the sample and binding buffer. For each chromatogram, the lysate of 2 L of *E. coli* culture (sample volume 26 mL; filtered through a 0.45 μm syringe filter) was loaded on a 2 mL Ni Sepharose High Performance column (XK 16/20 column) using ÄKTApurifier chromatography system (now replaced by ÄKTA pure). The kinase was eluted in a two-step gradient with 50% and 100% of elution buffer. (C) SDS-PAGE (12% gel) of (His)<sub>6</sub>-PknG fractions showing eluates without (-) and with (+) 45 mM imidazole in the binding buffer. Data kindly provided by K. Hölscher, M. Richter-Roth and B. Felden de Neuman, GPC Biotech AG, Martinsried, Germany.

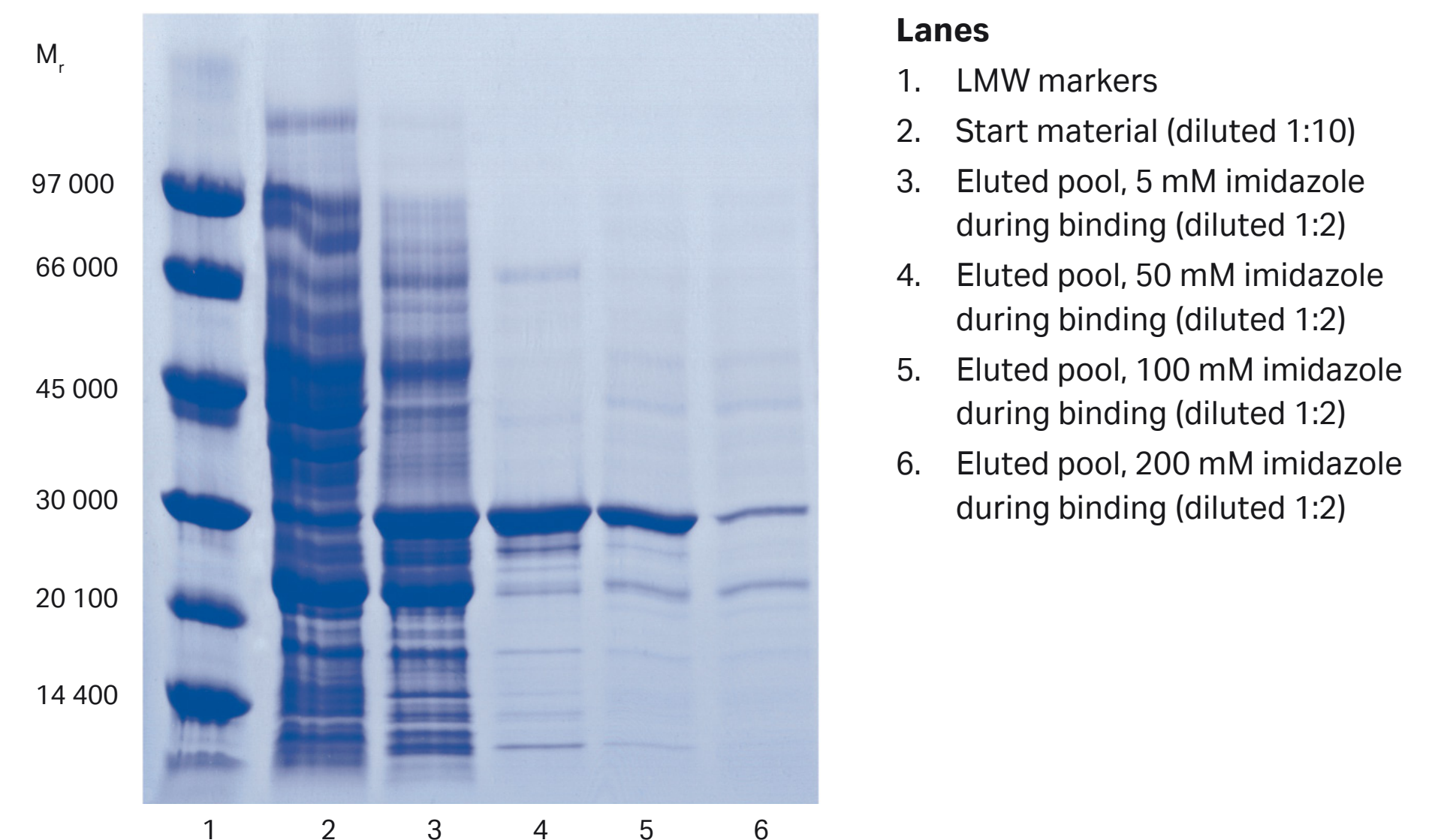
## 2. Determining optimal imidazole concentration using His SpinTrap

The imidazole concentration during binding and washing is an important factor for the final purity and yield of the target protein. His SpinTrap is a convenient and fast tool for determination of optimal imidazole concentration. Optimization is important for both purity and yield of the target protein. This was demonstrated by a series of experiments where a histidine-tagged protein, APB7-(His)<sub>6</sub> (M<sub>r</sub> 28 000), was purified on His SpinTrap using 5, 50, 100, or 200 mM imidazole in sample and binding buffers. The elution buffer contained 500 mM imidazole.

An imidazole concentration of 5 mM resulted in low purity of the eluted sample (Fig 4.2, lane 3), while an increase to 50 mM imidazole prevented binding of most contaminants and improved purity (Fig 4.2, lane 4). Including 100 mM imidazole in the sample and binding buffer lowered the yield while purity was improved marginally (Fig 4.2, lane 5). The lower yield can be explained by less binding of target protein due to the competitive effect of the high imidazole concentration during binding and washing. Further increase to 200 mM imidazole reduced yield even more (Fig 4.2, lane 6).

This example shows that higher imidazole concentrations during binding improve the purity, whereas too high of a concentration decreases the yield. The optimal imidazole concentration during binding is protein dependent. For many proteins, 20 to 40 mM imidazole is the best choice for His SpinTrap.

<i>Column:</i>	His SpinTrap
<i>Equilibration:</i>	600 μL binding buffer
<i>Sample application:</i>	600 μL clarified <i>E. coli</i> BL-21 lysate containing 400 μg APB7-(His) <sub>6</sub>
<i>Wash:</i>	600 μL binding buffer
<i>Elution:</i>	2 × 200 μL elution buffer
<i>Binding buffer:</i>	20 mM sodium phosphate, 500 mM NaCl, 5–200 mM imidazole, pH 7.4
<i>Elution buffer:</i>	20 mM sodium phosphate, 500 mM NaCl, 500 mM imidazole, pH 7.4



**Fig 4.2.** SDS-PAGE under reducing conditions (ExcelGel SDS Gradient 8–18) of histidine-tagged APB7 protein. The imidazole concentration during binding affects the final purity and yield (compare lanes 3, 4, 5, and 6).



## Optimizing using different metal ions

The strength of binding between a protein and a metal ion is affected by several factors, including the structure and characteristics of the target protein, the presence and properties of the protein affinity tag, the properties of the metal ion, and the pH and composition of the binding buffer. As a result, Ni<sup>2+</sup>, the metal ion considered to have the strongest affinity to histidine-tagged proteins, may not always be the best choice for a given application. Under some circumstances, therefore, other transition metal ions, such as Co<sup>2+</sup>, Cu<sup>2+</sup>, Fe<sup>2+</sup>, and Zn<sup>2+</sup>, may be better suited.

In general, we recommend Ni Sepharose High Performance or Ni Sepharose 6 Fast Flow chromatography media, precharged with Ni<sup>2+</sup> ions, for high capacity. If increased selectivity and higher purity would be advantageous, TALON Superflow, precharged with Co<sup>2+</sup>, is a good choice. For altered selectivity, other metal ions can be tested using uncharged IMAC Sepharose High Performance or IMAC Sepharose 6 Fast Flow.

The following guidelines may assist in devising preliminary experiments to determine the metal ion most suitable for a given separation:

- Ni<sup>2+</sup> is generally used for histidine-tagged recombinant proteins
- Co<sup>2+</sup> is also used for purification of histidine-tagged proteins, since it may allow weaker binding and reduce the amount of contaminants that may bind
- Cu<sup>2+</sup> and Zn<sup>2+</sup> are frequently used for purification of untagged proteins. Cu<sup>2+</sup> gives relatively strong binding to a range of proteins; some proteins will only bind to Cu<sup>2+</sup>. Zn<sup>2+</sup> ions often bind more weakly, a characteristic that is often exploited to achieve selective elution of the target protein. Both Cu<sup>2+</sup> and Zn<sup>2+</sup> can be used for histidine-tagged proteins and for process-scale separations.
- Fe<sup>3+</sup> is used more rarely than other metal ions. Take extra precautions when working with Fe<sup>3+</sup>, as it reduces easily in neutral solutions. Fe<sup>3+</sup> is frequently used for purification of phosphopeptides, since the phosphate group has strong affinity for Fe<sup>3+</sup>. Chromatography on immobilized Fe<sup>3+</sup> should be done at pH <3, to eliminate non-specific interactions from carboxyl groups. We also advise stripping immobilized Fe<sup>3+</sup> ions after each run and recharging the column as required. Strongly bound Fe<sup>3+</sup> ions and ferric compounds can be removed by leaving the medium in 50 mM EDTA overnight.

Below we present two examples showing how the selection of the most suitable metal ion and experimental conditions (including imidazole concentration) affects the purification of a given target protein.

## 1. Comparison study using Cu<sup>2+</sup>, Zn<sup>2+</sup>, and Ni<sup>2+</sup> on HiTrap IMAC FF

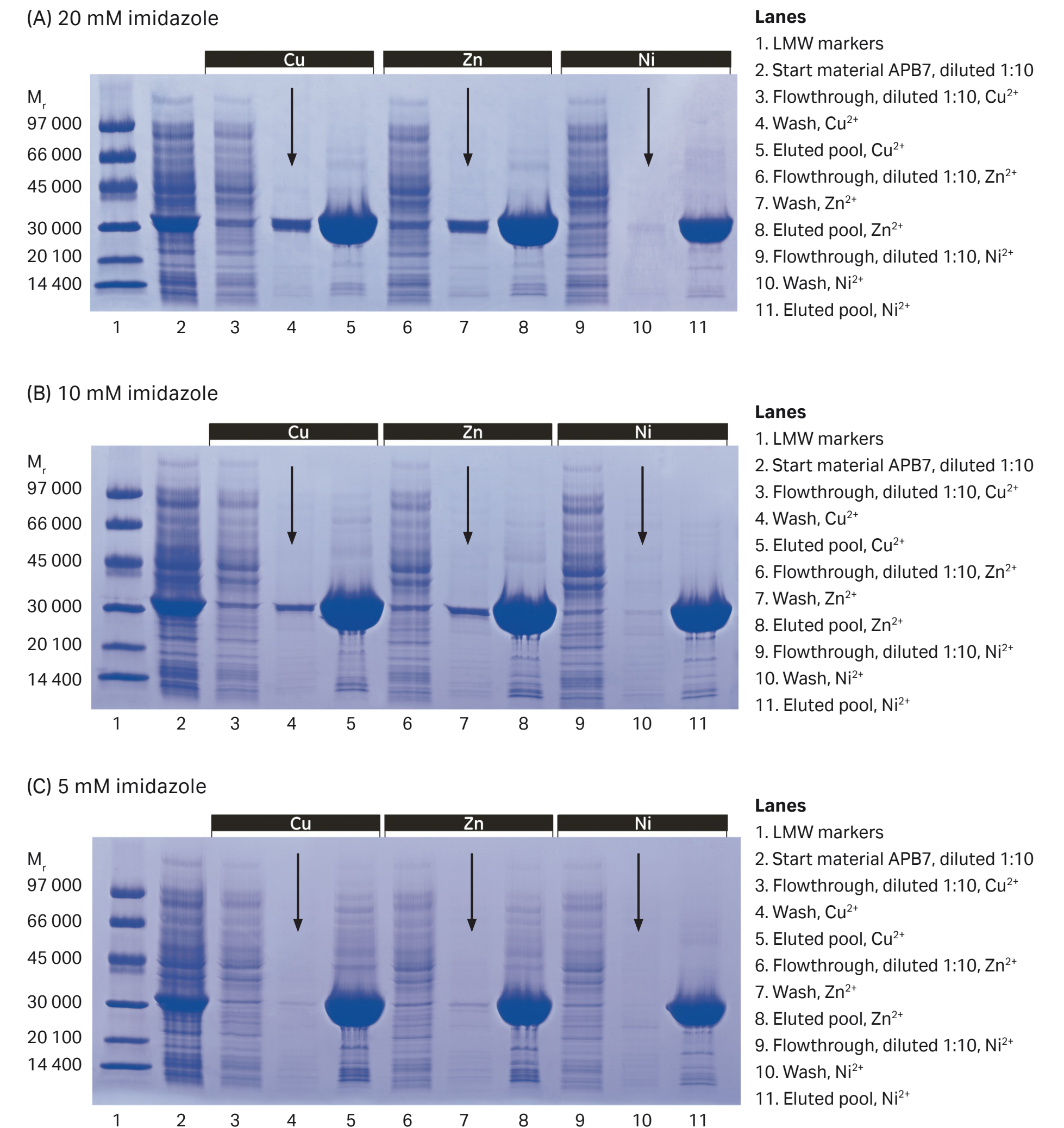
In this study, APB7, a (histidine)<sub>6</sub>-tagged protein (M<sub>r</sub> 28 000) expressed in *E. coli* BL-21, was purified on HiTrap IMAC FF 1 mL columns (prepacked with IMAC Sepharose 6 Fast Flow) and charged separately with Cu<sup>2+</sup>, Zn<sup>2+</sup>, and Ni<sup>2+</sup>.

Screening experiments were performed to determine the optimal imidazole concentration for each ion [see Figure 4.3 (A to C)]. The results of each of these three purifications indicate:

- At 20 mM imidazole, there was significant leakage of target protein in the wash with Cu<sup>2+</sup> and Zn<sup>2+</sup> (see arrows in Fig 4.3 A), a sign that imidazole concentration was too high to allow maximal yield. Very little leakage was seen with Ni<sup>2+</sup>. Purity was excellent in all three cases.
- At 10 mM imidazole, leakage of target protein in the wash was significantly reduced for Cu<sup>2+</sup> and Zn<sup>2+</sup>. The purity of the target protein in the eluted pool was similar with all three metal ions, but not as pure as with 20 mM imidazole.
- At 5 mM imidazole, no leakage occurred with any of the metal ions. Ni<sup>2+</sup> provided the purest protein, though still not as pure as with 20 mM imidazole.

Note that a large amount of sample was applied in the SDS-polyacrylamide gel. Because of this, the gels show a number of contaminants in the eluted material even though the purity was very high.

The results illustrate that, for any given metal ion, imidazole concentration can be adjusted to achieve high yield, high purity, or a successful compromise. IMAC Sepharose media typically requires a slightly higher concentration of imidazole in the wash buffer than similar IMAC media on the market. A good starting point for most separations is to include 20 to 40 mM imidazole in the binding and wash buffers using IMAC Sepharose 6 Fast Flow or IMAC Sepharose High Performance. Be sure to use highly pure imidazole, which gives essentially no absorbance at 280 nm. To remove imidazole from the protein, use a desalting column (see Chapter 11).



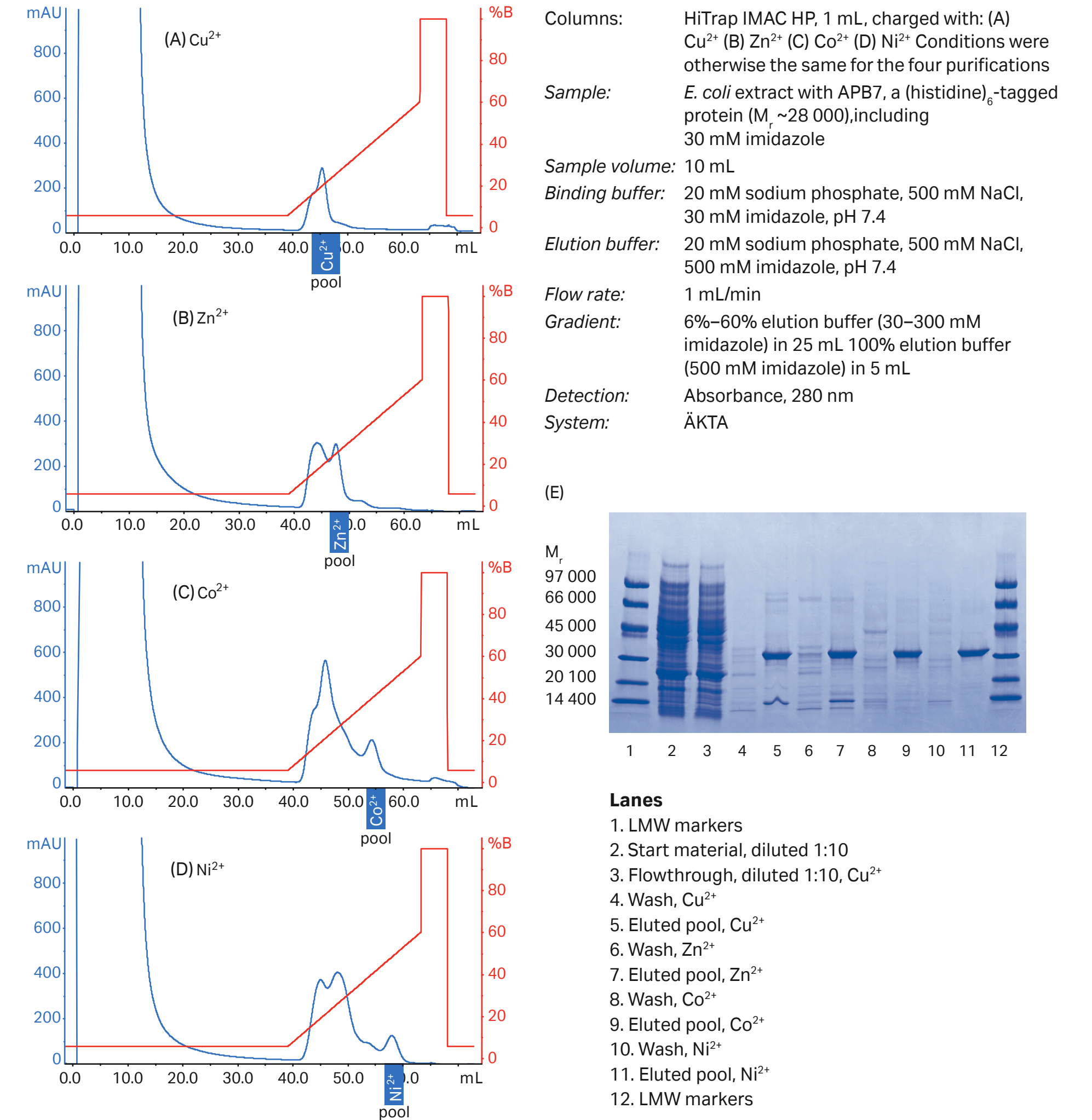
**Fig 4.3.** SDS-PAGE analyses (reducing conditions) of fractions from the purification of APB7 using IMAC Sepharose 6 Fast Flow, prepacked in HiTrap IMAC FF 1 mL columns, charged with either Cu<sup>2+</sup>, Zn<sup>2+</sup>, or Ni<sup>2+</sup>, and with (A) 20 mM imidazole in the sample, (B) 10 mM imidazole in the sample, or (C) 5 mM imidazole in the sample. The gels were stained with Coomassie.



## 2. Optimization of purity using Cu<sup>2+</sup>, Zn<sup>2+</sup>, Co<sup>2+</sup>, and Ni<sup>2+</sup> on HiTrap IMAC HP

Successful purifications require attention to the properties of the target protein and the affinity of the target protein toward the metal ion used. Four different HiTrap IMAC HP 1 mL columns prepacked with IMAC Sepharose High Performance were charged separately with four different metal ions: Cu<sup>2+</sup>, Zn<sup>2+</sup>, Co<sup>2+</sup>, and Ni<sup>2+</sup>. Purification performance was assessed using the target protein APB7 (M<sub>r</sub> 28 000), expressed in *E. coli*.

The results demonstrate the importance of screening samples to determine the most suitable metal ion and purification conditions for specific target proteins. For APB7, the highest purity was achieved using Ni<sup>2+</sup> or Co<sup>2+</sup>, but the difference compared with the results for Zn<sup>2+</sup> and Cu<sup>2+</sup> was small (Fig 4.4). The gradient elutions with imidazole employed in these examples also offer a methodology for selecting the appropriate imidazole concentration for a given purification.



**Fig 4.4.** Purification of APB7, a (histidine)<sub>6</sub>-tagged protein expressed in *E. coli* BL-21 on four different HiTrap IMAC HP 1 mL columns charged separately with metal ions. (A) Cu<sup>2+</sup>, (B) Zn<sup>2+</sup>, (C) Co<sup>2+</sup>, or (D) Ni<sup>2+</sup>. Pools selected after SDS-PAGE of individual 1 mL fractions (not shown) are indicated. (E) SDS-PAGE analysis: reducing conditions on ExcelGel SDS Gradient 8–18; Coomassie staining.



## Optimizing using multistep purifications

Target protein can be further purified by adding one or more additional purification steps, as shown in the examples to the right. This topic is discussed in detail in Chapter 9.

To the right we present two examples showing successful multistep purification of the target proteins.

### 1. Two-step purification of a high-molecular-weight (histidine)<sub>10</sub>-tagged protein using AC and SEC

In a two-step purification of (His)<sub>10</sub>-trx-p450 (histidine-tagged at the N-terminus, 10 histidine residues) produced in *E. coli*, a HisTrap FF column was used in the first step. The eluted pool was then applied to a HiLoad 16/60 Superdex 200 pg column for further purification by SEC.

Three major bands were detected after the first purification step (Fig 4.5B, lane 5). Lane 6 (pool 2 from SEC) contains full-length target protein. Lanes 7 and 8 (pools 3 and 4, respectively) contain truncated forms of the target protein, as verified by N-terminal sequencing (data not shown). Lane 9 (pool 1) from SEC contains aggregated proteins. Thus subsequent SEC provided very good separation between the truncated forms and the full-length target protein, (His)<sub>10</sub>-trx-p450.

**Columns:** AC: HisTrap FF 1 mL  
SEC: HiLoad 16/60 Superdex 200 pg, 120 mL

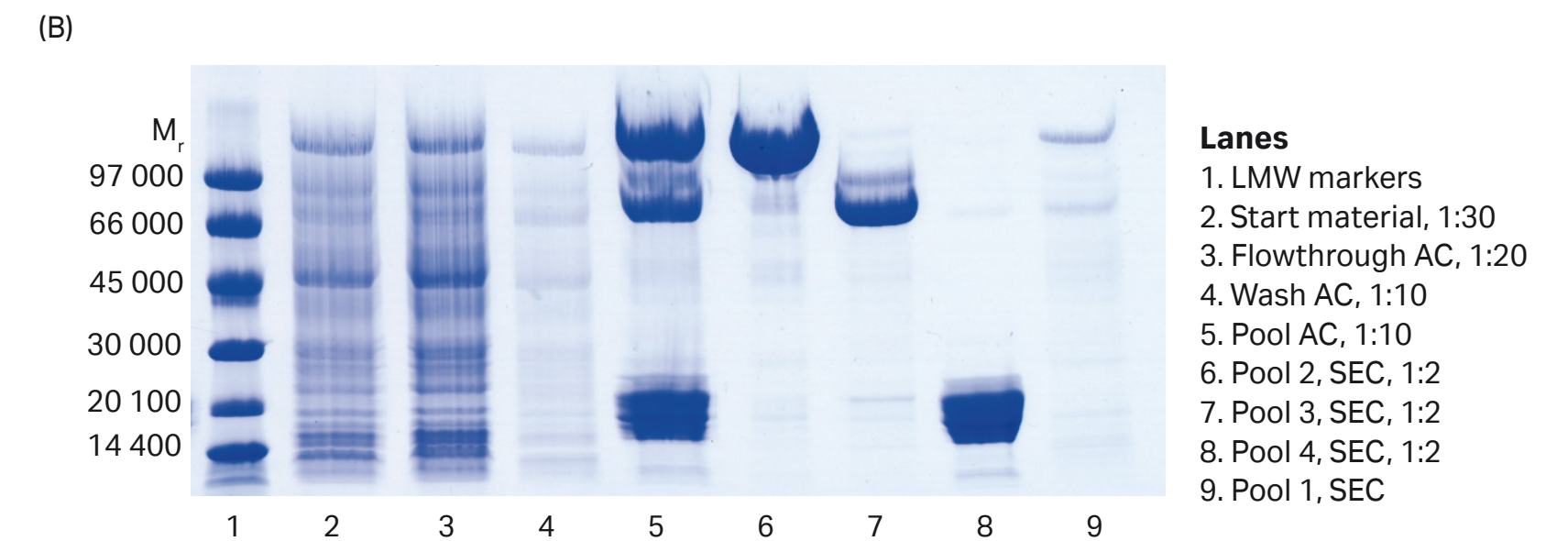
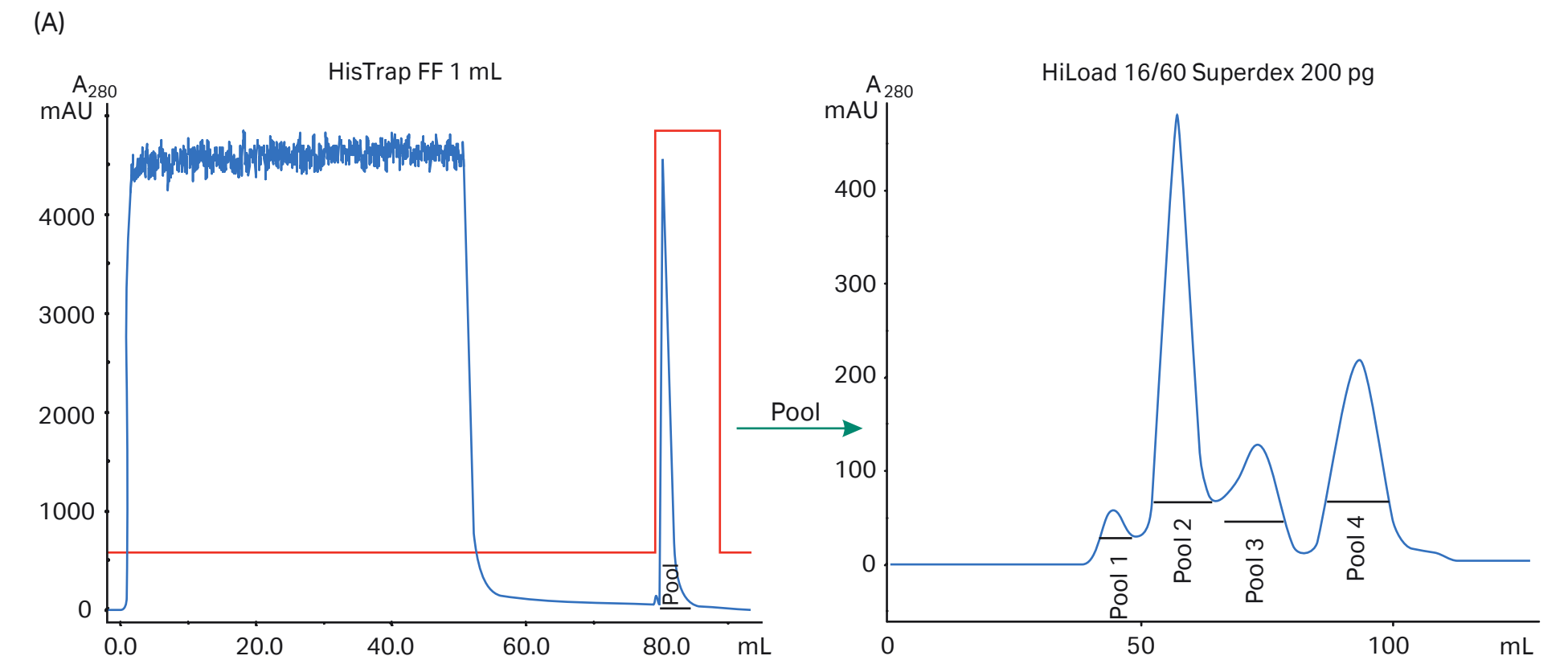
**Sample:** *E. coli* extract with (His)<sub>10</sub>-trx-p450, ( $M_r \sim 130\ 000$ )

**Sample volumes:** 50 mL (AC), 5.2 mL (SEC)

**Binding buffer:** AC: 20 mM sodium phosphate, 60 mM imidazole, 500 mM NaCl, pH 7.4

**Elution buffer:** AC: 20 mM sodium phosphate, 500 mM imidazole, 500 mM NaCl, pH 7.4  
SEC: 20 mM phosphate, 0.28 M NaCl, 6 mM KCl, pH 7.4

**Flow rate:** AC: 1 mL/min  
SEC: 0.5 mL/min

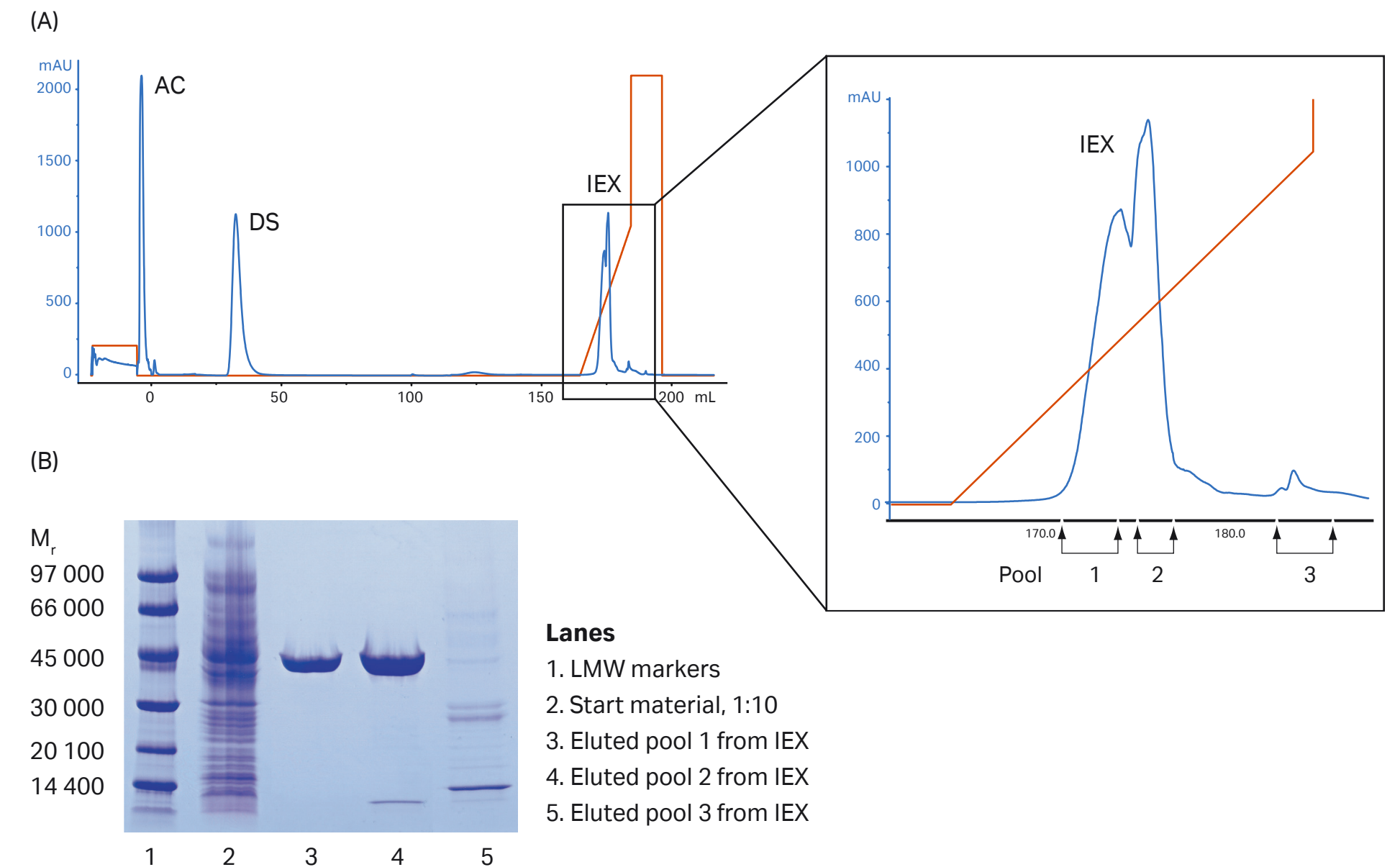


**Fig 4.5.** (A) Two-step purification of a high-molecular-weight (histidine)<sub>10</sub>-tagged protein using AC followed by SEC. (B) SDS-PAGE under reducing conditions and Coomassie staining.

## 2. Automatic three-step purification of unclarified cell lysate on ÄKTExpress

An automated three-step protocol was used to purify histidine-tagged maltose binding protein from 100 mL of an unclarified *E. coli* cell lysate. The three steps were: Affinity chromatography (AC) using HisTrap FF crude (1 mL column), desalting (DS) using HiPrep 26/10 Desalting, and ion exchange chromatography (IEX) using Mono Q™ 5/50 GL. These are referred to as AC-DS-IEX in the image. As can be seen from the SDS-PAGE analysis, the target protein was obtained highly pure and in good yield.

<b>Columns:</b>	Affinity chromatography (AC): HisTrap FF crude, 1 mL
	Desalting (DS): HiPrep 26/10 Desalting
	Ion exchange (IEX): Mono Q 5/50 GL
<b>Sample:</b>	Histidine-tagged Maltose Binding Protein, MBP-(His) <sub>6</sub> , M <sub>r</sub> 43 000, in <i>E. coli</i> DH5α extract
<b>Sample volume:</b>	100 mL
<b>AC binding buffer:</b>	50 mM Tris-HCl, 0.5 M NaCl, 20 mM imidazole, pH 8.0
<b>AC elution buffer:</b>	50 mM Tris-HCl, 0.5 M NaCl, 500 mM imidazole, pH 8.0
<b>DS/IEX binding buffer:</b>	50 mM Tris-HCl, pH 8.0
<b>IEX elution buffer:</b>	50 mM Tris-HCl, 1.0 M NaCl, pH 8.0



**Fig 4.6.** (A) AC-DS-IEX with an enlargement of the IEX peaks and the collected pools to the right. Yield: 9.4 mg in pools 1 + 2. (B) SDS-PAGE of eluted pools from IEX. The gel was stained with Coomassie.

**05**

# **Purification of GST-tagged recombinant proteins**



The Glutathione S-transferase (GST) affinity tag system is a complete, versatile system from Cytiva for the expression, purification, and detection of GST-tagged proteins produced in *E. coli*. The system consists of three major components: pGEX plasmid vectors, products for GST purification, and a GST detection kit. A series of site-specific proteases complements the system.

The pGEX vectors are designed for inducible, high-level intracellular expression of genes or gene fragments as fusions with GST. Expression in *E. coli* yields tagged proteins with the GST moiety at the amino terminus and the protein of interest at the carboxyl terminus. The crystal structure of recombinant *Schistosoma japonicum* GST ( $M_r$  26 000) used in the pGEX vectors has been determined.

The purification method is based on the affinity of GST to the glutathione ligand coupled to a matrix. The binding of a GST-tagged protein to the ligand is reversible, and the protein can be eluted under mild, nondenaturing conditions by the addition of reduced glutathione to the elution buffer. The technique thus provides a mild purification process that does not affect a protein's native structure and function.

A variety of AC products are available from Cytiva that have glutathione immobilized to one of three Sepharose chromatography media: Sepharose High Performance (HP), Sepharose 4 Fast Flow (FF), or Sepharose 4B. The Glutathione Sepharose media are available in several formats, ranging from 96-well filter plates, spin columns, and gravity-flow columns to prepacked HiTrap and HiPrep columns to lab packs (media packs in sizes from 10 mL to 500 mL). The chromatography media vary in their performance parameters: Glutathione Sepharose 4B has the highest capacity, Glutathione Sepharose 4 Fast Flow is suitable for scale-up, and Glutathione Sepharose High Performance has the highest resolution.

Tagged proteins that possess the complete amino acid sequence of GST also demonstrate GST enzymatic activity and can undergo dimerization similar to that observed in nature. If desired, cleavage of the protein from GST can be achieved using a site-specific protease whose recognition sequence is located immediately upstream from the multiple cloning site on the pGEX plasmids. Tagged proteins can be detected using colorimetric or immunological methods. Cleavage and detection options are discussed later in this chapter. Refer to Fig 5.1 and Table 5.1 for an overview of the GST purification products. A comparison of the physical characteristics of the three Glutathione Sepharose media is given in Appendix 2. Table 5.2 summarizes companion products for subcloning, detection, and cleavage of GST-tagged proteins.

This chapter summarizes key aspects of working with GST-tagged proteins, with a focus on purification methodologies. For more detailed information on the GST system, refer to the *GST Gene Fusion System Handbook*, 18115758 from Cytiva; the handbook includes detailed information on expression, purification, detection, and removal of the GST tag and is an invaluable guide when working with the system.

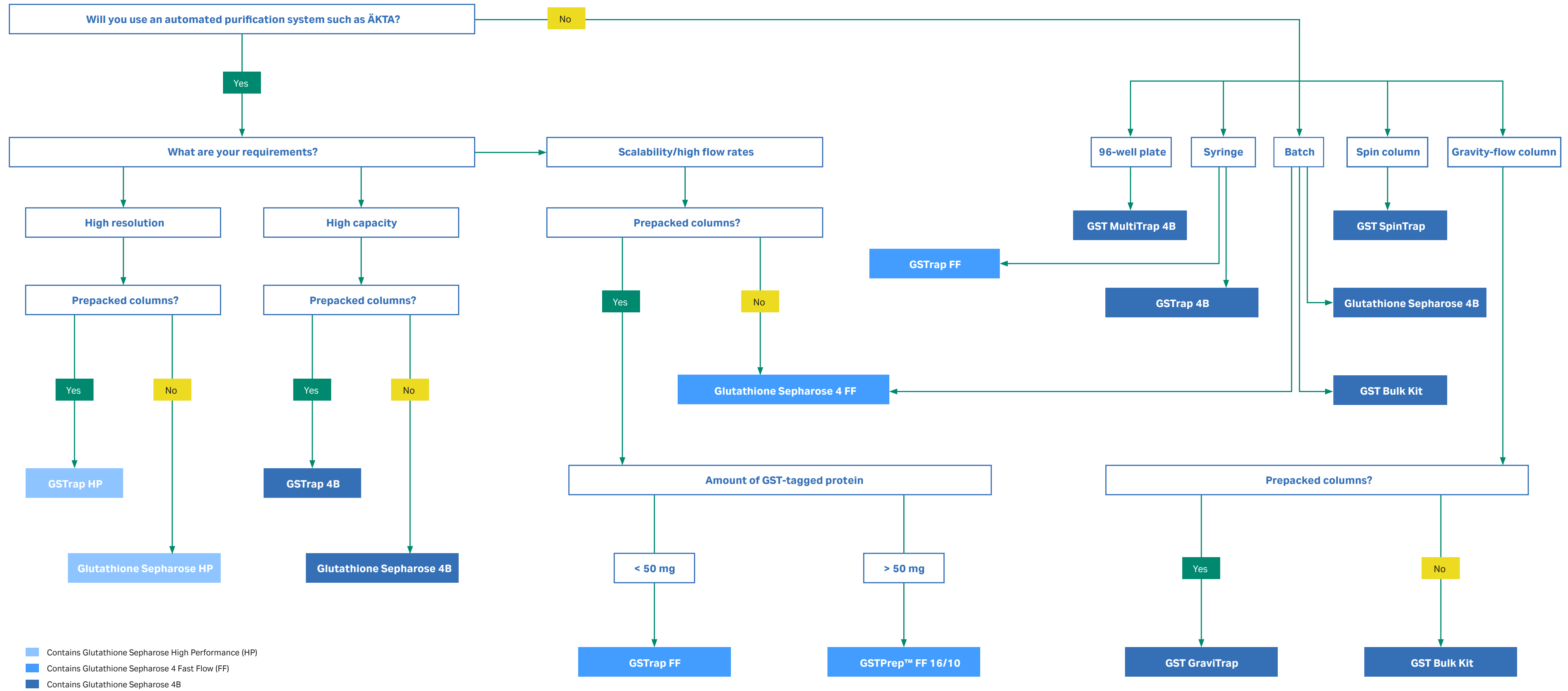


Fig 5.1. Selection guide for Glutathione Sepharose products.

**Table 5.1.** Purification options for GST-tagged proteins using Glutathione Sepharose products

Product	Format or column size	Approx. protein binding capacity <sup>1</sup>	Description <sup>2</sup>	High-throughput screening	Minipreps	Batch/gravity flow	Syringe compatible	ÄKTA system compatible
Glutathione Sepharose High Performance	25 mL	7 mg rGST/mL	For high resolution and elution of a more concentrated sample (high-performance purification).	•				•
	100 mL			•				•
GSTrap HP	5 × 1 mL	7 mg rGST/column 35 mg rGST/column	For reliable, high-resolution purification at laboratory scale. For use with a peristaltic pump or chromatography system in preference over syringe.					•
	1 × 5 mL						•	
	5 × 5 mL						•	
Glutathione Sepharose 4 Fast Flow	25 mL	10 mg rGST/mL	For batch or column purification and scale-up due to good flow properties.	•	•	•		•
	100 mL			•	•	•	•	
	500 mL			•	•	•	•	
GSTrap FF	2 × 1 mL	10 mg rGST/column	For scale-up due to high flow rates. For use with syringe, peristaltic pump, or chromatography system.				•	•
	5 × 1 mL						•	
	1 × 5 mL	50 mg rGST/column					•	•
	5 × 5 mL						•	•
GSTPrep FF 16/10	1 × 20 mL	200 mg rGST/column	Provides additional capacity for scale-up purification. For use with a chromatography system.					•
Glutathione Sepharose 4B	10 mL	25 mg horse liver GST/mL	For high binding capacity	•	•	•		
	100 mL			•	•	•		
	300 mL			•	•	•		
GSTrap 4B	5 × 1 mL	25 mg horse liver GST/column 125 mg horse liver GST/column	For high binding capacity. For use with syringe, peristaltic pump, or chromatography system.				•	•
	1 × 5 mL						•	
	5 × 5 mL						•	
GST GraviTrap	10 × 2 mL	50 mg horse liver GST/column	Simple purification with gravity-flow columns. No system needed.			•		
GST Bulk Kit	1 kit	25 mg/mL medium	Batch purification or gravity-flow column chromatography. Reagents for induction, expression, and elution of GST-tagged proteins.			•		
GST SpinTrap	50 × 50 µL	500 µg horse liver GST/column	For small-scale purification from clarified cell lysates, also suitable for screening of cell lysates. For use in a standard microcentrifuge.		•			
GST MultiTrap 4B	4 × 96-well filter plate	500 µg horse liver GST/well	For convenient high-throughput parallel screening. Can load unclarified cell lysates. Consistent performance, high reproducibility. For use with robotics or manually by centrifugation or vacuum.	•				
GST Buffer Kit	1 kit	N/A		•	•	•	•	•

<sup>1</sup> The binding of GST-tagged proteins depends on size, conformation, and concentration of the protein in the sample loaded. Binding of GST to glutathione is also flow dependent, and lower flow rates often increase the binding capacity. This is important during sample loading. Protein characteristics, pH, and temperature may also affect the binding capacity.

<sup>2</sup> NOTE: In every package easy-to-follow instructions are included.

- Contains Glutathione Sepharose High Performance (HP)
- Contains Glutathione Sepharose 4 Fast Flow (FF)
- Contains Glutathione Sepharose 4B



**Table 5.2.** Companion products useful for subcloning, detection, and cleavage of GST-tagged proteins

Product	Pack size	Capacity	Description	Application
pGEX Vectors (GST Gene Fusion System)	5 to 25 µg	N/A	Vector	A <i>tac</i> promoter for chemically inducible, high-level expression. PreScission Protease, thrombin, or Factor Xa recognition sites.
Anti-GST Antibody	0.5 mL	50 detections	Anti-GST antibody	Polyclonal. For sensitive and specific detection of GST-tagged proteins. For use with an enzyme-conjugated anti-goat antibody.
Anti-GST HRP Conjugate	75 µL	1:5000 dilution, typical concentration	Highly specific antibody to GST conjugated to HRP and optimized for use in Western blotting with ECL detection reagents	Polyclonal. Offers speed, sensitivity, and safety for detection of GST-tagged proteins. Recognizes multiple epitopes of GST, thus not reliant on functional GST for detection.
GST Detection Module	1-chloro-2-4-dinitrobenzene (CDNB), Anti-GST Antibody, and instructions	50 detection reactions	GST Detection Module	For the biochemical or immunological detection of GST-tagged proteins. Glutathione and CDNB serve as substrates to yield a yellow product detectable at 340 nm. The antibody is suitable for use in Western blots.
PreScission Protease	500 units	One unit cleaves > 90% of 100 µg of a test GST-tagged protein when incubated in 1 mM EDTA, 1 mM DTT, 150 mM NaCl, and 50 mM Tris-HCl (pH 7.0) at 5°C for 16 h	PreScission Protease	For specific, low-temperature cleavage between Gln and Gly residues in the sequence Leu-Glu-Val-Leu-Phe-Gln-Gly-Pro. A tagged protein consisting of human rhinovirus protease and GST. Can be used for tag cleavage when the PreScission Protease recognition sequence occurs between the tag sequence and the protein of interest, e.g., the GST tag from proteins expressed using the pGEX-6P vector.
Thrombin	500 units	One unit cleaves > 90% of 100 µg of a test GST-tagged protein when incubated in 1× PBS at 22°C for 16 h	Thrombin	Serine protease for specific cleavage at the recognition sequence for thrombin. Can be used for tag cleavage when the thrombin recognition sequence occurs between the tag sequence and the protein of interest, e.g., the GST tag from proteins expressed using the pGEX-T vectors.
Factor Xa	400 units	One unit cleaves > 90% of 100 µg of a test GST-tagged protein when incubated in 1 mM CaCl <sub>2</sub> , 100 mM NaCl, and 50 mM Tris-HCl (pH 8.0) at 22°C for 16 h	Factor Xa	Serine protease for specific cleavage following the tetrapeptide Ile-Glu-Gly-Arg. Can be used for tag cleavage when the Factor Xa recognition sequence occurs between the tag sequence and the protein of interest, e.g., the GST tag from proteins expressed using pGEX-X vectors.
HiTrap Benzamidine FF (high sub)	2 × 1 mL 5 × 1 mL 1 × 5 mL	> 35 mg trypsin  > 175 mg trypsin	Columns prepacked with Benzamidine Sepharose 4 Fast Flow (high sub)	Removal of serine proteases, e.g., thrombin and Factor Xa after tag cleavage.
Benzamidine Sepharose 4 Fast Flow (high sub)	25 mL	> 35 mg trypsin/mL medium	Lab pack	Removal of serine proteases, e.g., thrombin and Factor Xa after tag cleavage.
Collection Plate	96-well plates	500 µL	V-shaped bottom	For use with the GST MultiTrap products.

## Expression

Selecting an expression strategy begins with choosing the vector best suited for your purpose, taking note of reading frame, cloning sites, and protease cleavage sites. Correct preparation of the insert is important and must take into account the reading frame and orientation, size, and compatibility of the fragment ends. Selection of host cells involves consideration of cloning and maintenance issues and anticipated expression levels. Finally, growth conditions must be evaluated in order to optimize expression. These topics are discussed below.

### pGEX vectors

GST-tagged proteins are constructed by inserting a gene or gene fragment into the multiple cloning site of one of the pGEX vectors. Expression is under the control of the *tac* promoter, which is induced by the lactose analog isopropyl  $\beta$ -D thiogalactoside (IPTG). All pGEX vectors are also engineered with an internal *lacI<sup>q</sup>* gene. The *lacI<sup>q</sup>* gene product is a repressor protein that binds to the operator region of the *tac* promoter, preventing expression until induction by IPTG, thus maintaining tight control over expression of the insert.

Because of the mild elution conditions for release of tagged proteins from the affinity medium, effects on native structure and functional activity of the protein are minimized. The vectors have a range of protease cleavage recognition sites as shown in Table 5.3.



**Table 5.3.** Protease cleavage sites of pGEX vectors

Vector	Cleavage enzyme
pGEX-6P-1, pGEX-6P-2, pGEX-6P-3	PreScission Protease
pGEX-2T, pGEX -1 $\lambda$ T, pGEX-4T-1, pGEX-4T-2, pGEX-4T-3	Thrombin
pGEX-3X, pGEX-5X-1, pGEX-5X-2, pGEX-5X-3	Factor Xa
pGEX-2TK Allows detection of expressed proteins by direct labeling <i>in vitro</i>	Thrombin

The vectors provide all three translational reading frames beginning with the *EcoR* I restriction site (see Appendix 9). The same multiple cloning sites in each vector ensure easy transfer of inserts. pGEX-6P-1, pGEX-4T-1, and pGEX-5X-1 can directly accept and express cDNA inserts isolated from  $\lambda$ gt11 libraries.

pGEX-2TK has a different multiple cloning site from that of the other vectors. pGEX-2TK is uniquely designed to allow the detection of expressed proteins by directly labeling the tagged products *in vitro*. This vector contains the recognition sequence for the catalytic subunit of cAMP-dependent protein kinase obtained from heart muscle. The protein kinase site is located between the thrombin recognition site and the multiple cloning site. Expressed proteins can be directly labeled using protein kinase and [ $\gamma$ - $^{32}$ P]ATP and readily detected using standard radiometric or autoradiographic techniques.


Refer to Appendix 9 for a listing of the control regions of the pGEX vectors. Complete DNA sequences and restriction site data are available with each individual vector's product information, at the Cytiva Web site <http://www.cytiva.com>, and also from GenBank™. GenBank accession numbers are listed in Appendix 9.

-  Select the proper vector to match the reading frame of the cloned insert.
-  Consider which protease and conditions for cleavage are most suitable for your target protein preparation.


pGEX-6P PreScission Protease vectors offer the most efficient method for cleavage and purification of GST-tagged proteins. Site-specific cleavage may be performed with simultaneous immobilization of the protease on the column. The protease has high activity at low temperature so that all steps can be performed in the cold room to protect the integrity of the target protein. Cleavage enzyme and GST tag are removed in a single step, as described later in this chapter.

## The host

Although a wide variety of *E. coli* host strains can be used for cloning and expression with the pGEX vectors, there are specially engineered strains that are more suitable and that may maximize expression of full-length tagged proteins. Strains deficient in known cytoplasmic protease gene products, such as *Lon*, *OmpT*, *DegP* or *HtpR*, may aid in the expression of tagged proteins by minimizing the effects of proteolytic degradation by the host.

 Using *E. coli* strains that are not protease-deficient may result in proteolysis of the tagged protein, seen as multiple bands on SDS-polyacrylamide gels or Western blots.

*E. coli* BL21, a strain defective in OmpT and Lon protease production, gives high levels of expression of GST-tagged proteins. It is the host of choice for expression studies with GST-tagged proteins. A lyophilized (noncompetent) culture of *E. coli* BL21 is available separately (code no. 27-1542-01).

 Use an alternative strain for cloning and maintenance of the vector (e.g., DH5 $\alpha$  or JM109) because BL21 does not transform well. Use an *E. coli* strain carrying the *recA1* allele (inactive form of *recA*) for propagation of pGEX plasmids to avoid rearrangements or deletions within plasmid DNA.

## Insert DNA

Insert DNA must possess an open reading frame and should be less than 2 kb long. Whether subcloned from another vector or amplified by PCR, the insert must have ends that are compatible with the linearized vector ends. Using two different restriction enzymes will allow for directional cloning of the insert into the vector. Directional cloning will optimize for inserts in the correct orientation.

## Optimizing expression

Once it has been established that the insert is in the proper orientation and that the correct junctions are present, the next step is to optimize expression of tagged proteins. The capability to screen crude lysates from many clones is critical to this process, so that optimal expression levels and growth conditions can be readily determined. GST MultiTrap 4B 96-well plates as well as GST SpinTrap are suitable products for screening purposes. Once conditions are established, one is ready to prepare large-scale bacterial sonicates of the desired clones.

In addition, several options are presented later in this chapter for determining expression levels.

Growth conditions should be evaluated for optimal expression, for example, cell culture media, growth temperature, culture density, induction conditions, and other variables should be evaluated. It is important to assure sufficient aeration and to minimize the time spent in each stage of growth, as well as to use positive selection for the plasmid (antibiotic resistance). Formation of inclusion bodies should be monitored and possibly be avoided by optimizing expression. This topic is discussed in Chapter 10.

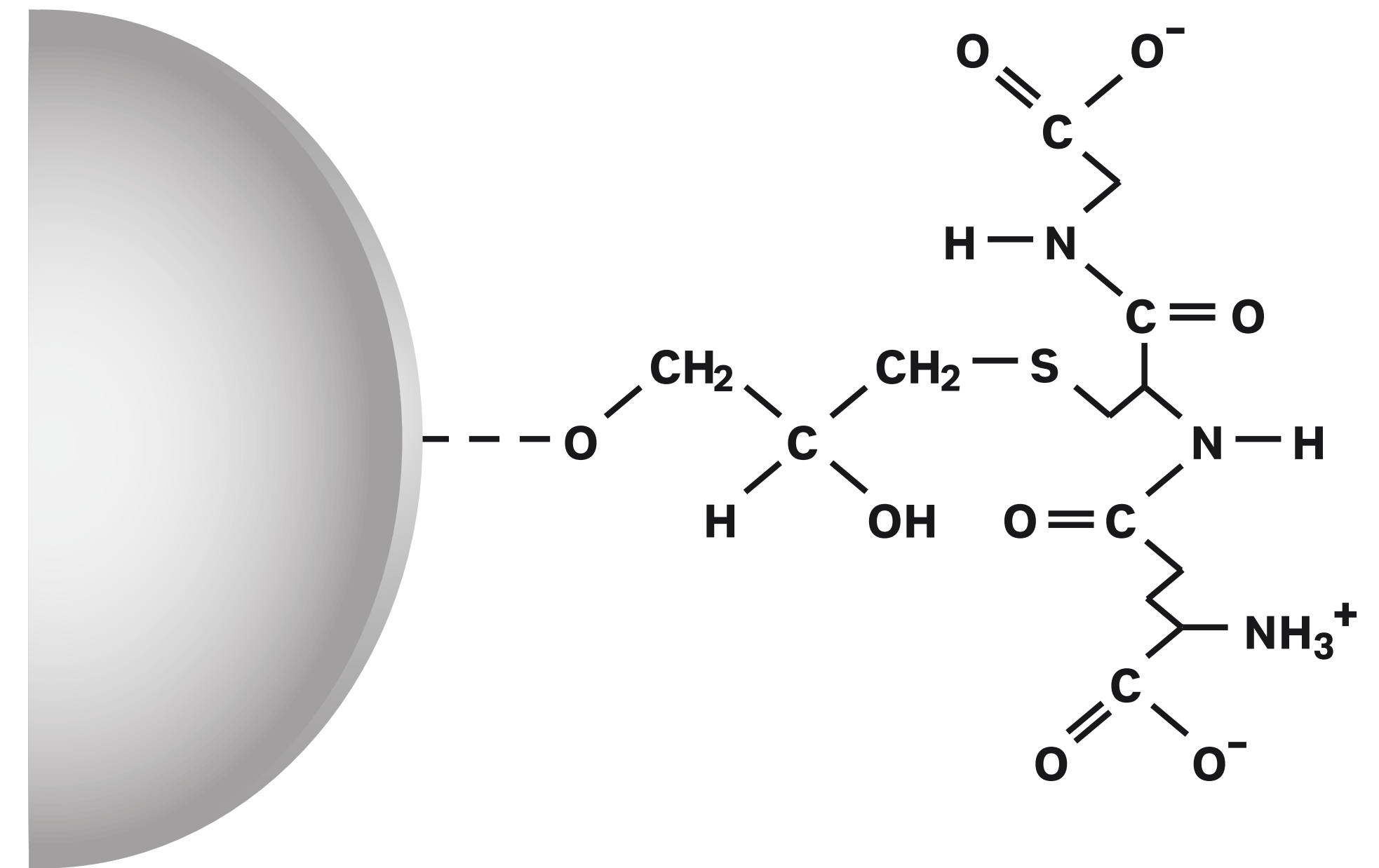
 Monitor both cell density ( $A_{600}$ ) and protein expression for each variable evaluated.



## Purification

GST-tagged proteins are easily purified from bacterial lysates by AC using glutathione immobilized to a matrix such as Sepharose (Fig 5.2). When applied to the affinity medium at low flow rate, the tagged proteins bind to the ligand, and impurities are removed by washing with binding buffer. Tagged proteins are then eluted from the Glutathione Sepharose under mild, nondenaturing conditions using reduced glutathione, to preserve both protein structure and function.

If separation of the cloned protein from the GST affinity tag is desired, the tagged protein can be digested with an appropriate site-specific protease while the protein is bound to Glutathione Sepharose. Alternatively, the tagged protein can be digested following elution from the medium (see later in this chapter for both of these alternatives). Cleavage of the bound tagged protein eliminates the extra step of separating the released protein from GST because the GST moiety remains bound to the medium while the protein is eluted using wash buffer.






**Fig 5.2.** Terminal structure of Glutathione Sepharose. Glutathione is specifically and stably coupled to Sepharose by reaction of the SH-group with oxirane groups obtained by epoxy-activation of the Sepharose matrix. The structure of glutathione is complementary to the binding site of glutathione S-transferase.



## General considerations for purification of GST-tagged proteins

Yield of tagged protein is highly variable and is affected by the nature of the tagged protein, the host cell, and the expression and purification conditions used. Tagged protein yields can range from 1 mg/L up to 10 mg/L. Table 5.4 can be used to approximate culture volumes based on an average yield of 2.5 mg/L.

Use deionized (or double-distilled) water and chemicals for sample and buffer preparation. Samples should be centrifuged immediately before use and/or filtered through a 0.45  $\mu\text{m}$  filter. If the sample is too viscous, dilute it with binding buffer to prevent it from clogging the column; increase lysis treatment (sonication, homogenization); or add DNase/RNase to reduce the size of nucleic acid fragments.

-  One of the most important parameters affecting the binding of GST-tagged proteins to Glutathione Sepharose is the flow rate. Because the binding kinetics between glutathione and GST are relatively slow, it is important to keep the flow rate low during sample application to achieve maximum binding capacity. Washing and elution can be performed at a slightly higher flow rate to save time. For batch purification, incubation time should be considered.
-  The binding properties of the target protein can be improved by adjusting the sample to the composition of the binding buffer. Dilute in binding buffer or perform a buffer exchange using a desalting column (see Chapter 11).
-  Volumes and times used for elution may vary among tagged proteins. Further elution with higher concentrations of glutathione (20 to 50 mM) may improve yield. At concentrations above 15 mM glutathione, the buffer concentration should also be increased to maintain the pH within the range 6.5 to 8. Flowthrough, wash, and eluted material from the column should be monitored for GST-tagged proteins using SDS-PAGE in combination with Western blot if necessary.

Following the elution steps, a significant amount of tagged protein may remain bound to the medium. Volumes and times used for elution may vary among tagged proteins. Additional elutions may be required. Eluates should be monitored for GST-tagged protein by SDS-PAGE or by 1-chloro-2,4 dinitrobenzene (CDNB) assay for GST detection (see later in this chapter).

-  If monomers are desired, the GST tag should be cleaved off (see Fig 5.20), because the GST-tagged protein can undergo dimerization.
-  Batch preparation procedures are frequently mentioned in the literature. However, the availability of prepacked columns and easily packed Glutathione Sepharose provides faster, more convenient alternatives. Batch preparations are occasionally used if it appears that the GST tag is not fully accessible or when the concentration of protein in the bacterial lysate is very low (both could appear to give a low yield from the affinity purification step). A more convenient alternative to improve yield is to decrease the flow rate or pass the sample through the column several times (recirculation).


**Table 5.4.** Reagent volume requirements for different protein yields

Tagged protein yield	50 mg	10 mg	1 mg	50 $\mu\text{g}$
Culture volume	20 L	4 L	400 mL	20 mL
Volume of extract	1 L	200 mL	20 mL	1 mL
Glutathione Sepharose bed volume	10 mL	2 mL	200 $\mu\text{L}$	10 $\mu\text{L}$
1 $\times$ PBS <sup>1</sup>	100 mL	20 mL	2 mL	100 $\mu\text{L}$
Glutathione elution buffer	10 mL	2 mL	200 $\mu\text{L}$	10 $\mu\text{L}$

<sup>1</sup> This volume is per wash. Three washes are required per sample in the procedures to the left.


Purification steps should be monitored using one or more of the detection methods described later in this chapter. The GST Detection Module contains components that can be used for either enzymatic or immunochemical determination of concentrations of GST-tagged proteins in extracts as well as sample obtained during purification.


The yield of protein in purified samples can also be determined by standard chromogenic methods (e.g., Lowry, BCA, Bradford, etc.). If a Lowry or BCA type method is to be used, the glutathione in the purified material must be removed using, for example, a desalting column (see Chapter 11) or dialysis against 2000 volumes of PBS to reduce interference with the assay. The Bradford method can be performed in the presence of glutathione.

 Reuse of purification columns and AC media depends upon the nature of the sample and should only be performed with identical samples to prevent cross-contamination.

## Selecting equipment for purification

The choice of equipment will depend on the specific purification. Many purification steps can be carried out using simple methods and equipment such as, for example, step-gradient elution using a syringe in combination with prepacked HiTrap columns. Linear gradients may improve purity when GST-tagged proteins are purified from eukaryotic hosts because endogenous GST may be co-eluted in step-gradient elution. If the same column is to be used for many runs in series, it is wise to use a dedicated system. Table 2.1 in Chapter 2 provides a guide to aid in selecting the correct purification system.

 For small-scale purifications or for high-throughput screening, we recommend GST MultiTrap 4B 96-well filter plates, which can purify up to approximately 0.5 mg of GST-tagged protein per well. In addition, GST SpinTrap columns, each containing 50  $\mu$ L of Glutathione Sepharose 4B, can purify up to 500  $\mu$ g of recombinant GST.

 For purification of larger quantities of GST-tagged proteins, prepacked columns such as GSTrap and GSTPrep FF 16/10 provide excellent formats. To increase capacity, use several GSTrap columns (1 mL or 5 mL) or two GSTPrep FF 16/10 columns (20 mL) in series or, for even larger capacity requirements, pack Glutathione Sepharose into a suitable column.



## Purification using Glutathione Sepharose High Performance, Glutathione Sepharose 4 Fast Flow, and Glutathione Sepharose 4B

These three chromatography media are all used for the purification of GST-tagged recombinant proteins and other S-transferases or glutathione-dependent proteins. They allow mild elution conditions that preserve protein structure and function. All are supplied preswollen in 20% ethanol and are also available in various prepacked formats, such as GSTrap, as described later in this chapter. See Appendix 2 for the main characteristics of all Glutathione Sepharose media.

In Glutathione Sepharose High Performance, the glutathione ligand is coupled to highly cross-linked 6% agarose. The medium has an average bead size of 34  $\mu\text{m}$  and can be used for high-resolution purification and elution of a more concentrated sample.

In Glutathione Sepharose 4 Fast Flow, the glutathione ligand is coupled to highly cross-linked 4% agarose. The medium has an average bead size of 90  $\mu\text{m}$ . It is a good choice for scale-up due to its good binding capacity and flow properties. This medium is also suitable for batch and gravity-flow purifications.

In Glutathione Sepharose 4B, the glutathione ligand is coupled to 4% agarose. The medium has an average bead size of 90  $\mu\text{m}$ . It provides very high binding capacity and is recommended for small-scale purification as well as batch and gravity-flow operations.



Glutathione Sepharose 4 Fast Flow and Glutathione Sepharose 4B are also available prepacked in 96-well filter plates. Procedures for both batch and column purification of GST-tagged proteins follow.



**Fig 5.3.** Glutathione Sepharose High Performance, Glutathione Sepharose 4 Fast Flow, and Glutathione Sepharose 4B for purification of GST-tagged proteins.

## Sample preparation

Refer to *General considerations for purification of GST-tagged proteins* for general considerations before beginning this procedure.


-  Adjust the sample to the composition and pH of the binding buffer by additions from concentrated stock solutions; by diluting the sample with binding buffer; or by buffer exchange.
-  Pass the sample through a 0.22 µm or a 0.45 µm filter and/or centrifuge it immediately before sample application. If the sample is too viscous, dilute it with binding buffer to prevent it from clogging; increase lysis treatment (sonication, homogenization); or add DNase/RNase to reduce the size of nucleic acid fragments.

## Buffer preparation

-  Use high-purity water and chemicals, and filter all buffers through a 0.45 µm filter before use.

Binding buffer: PBS (140 mM NaCl, 2.7 mM KCl, 10 mM Na<sub>2</sub>HPO<sub>4</sub>, 1.8 mM KH<sub>2</sub>PO<sub>4</sub>), pH 7.3


Elution buffer: 50 mM Tris-HCl, 10 mM reduced glutathione, pH 8.0

-  1 to 20 mM DTT may be included in the binding and elution buffers to reduce the risk of oxidation of free -SH groups on GST, which may cause aggregation of the tagged target protein, resulting in lower yield of GST-tagged protein.

## Batch purification of GST-tagged proteins using Glutathione Sepharose HP, Glutathione Sepharose 4 FF, or Glutathione Sepharose 4B

Glutathione Sepharose chromatography media are supplied preswollen in 20% ethanol. The media are used at a final slurry concentration of 50%.

1. Determine the bed volume of Glutathione Sepharose required for your purification.
2. Gently shake the bottle to resuspend the slurry.
3. Use a pipette or measuring cylinder to remove sufficient slurry for use and transfer to an appropriate container/tube.
4. Sediment the chromatography medium by centrifugation at 500 × g for 5 min. Carefully decant the supernatant.
5. Wash the Glutathione Sepharose HP, FF, or 4B by adding 5 mL of PBS per 1 mL of slurry (= 50% slurry).

-  Glutathione Sepharose media must be thoroughly washed with PBS to remove the ethanol storage solution because residual ethanol may interfere with subsequent procedures.

6. Sediment the chromatography medium by centrifugation at 500 × g for 5 min. Carefully decant the supernatant.
7. Repeat steps 5 and 6 once for a total of two washes.

For cleaning, storage, and handling information, refer to Appendix 2.

## Batch purification

1. Add the cell lysate to the prepared Glutathione Sepharose medium and incubate for at least 30 min at room temperature, using gentle agitation such as end-over-end rotation.
2. Use a pipette or cylinder to transfer the mixture to an appropriate container/tube.
3. Sediment the medium by centrifugation at  $500 \times g$  for 5 min. Carefully decant the supernatant (= flowthrough) and save it for SDS-PAGE analysis to check for any loss of unbound target protein.
4. Wash the Glutathione Sepharose medium by adding 5 mL of PBS per 1 mL of slurry (= 50% slurry). Invert to mix.
5. Sediment the medium by centrifugation at  $500 \times g$  for 5 min. Carefully decant the supernatant (= wash) and save it for SDS-PAGE analysis.
6. Repeat steps 4 and 5 twice for a total of three washes.
7. Elute the bound protein by adding 0.5 mL of elution buffer per 1 mL slurry of Glutathione Sepharose medium. Incubate at room temperature for 5 to 10 min, using gentle agitation such as end-over-end rotation.
8. Sediment the medium by centrifugation at  $500 \times g$  for 5 min. Carefully decant the supernatant (= eluted protein) and transfer to a clean tube.
9. Repeat steps 7 and 8 twice for a total of three elutions. Check the three eluates separately for purified protein and pool those eluates containing protein.

## Column purification of GST-tagged proteins using Glutathione Sepharose HP, Glutathione Sepharose 4 FF, or Glutathione Sepharose 4B

### Column packing

See instructions supplied with the products or refer to Appendix 6 for general guidelines for column packing.

### Purification

For recommended flow rates, see Appendix 6, Table A6.6.

1. Equilibrate the column with approximately 5 column volumes of binding buffer.
2. Apply the pretreated sample at low flow rate (approximately one-third of the flow rate used during wash and elution).
3. Wash the column with 5 to 10 column volumes of binding buffer or until no material appears in the flowthrough. Save the flowthrough for SDS-PAGE analysis to check for any loss of unbound target protein.
4. Elute the bound protein with 5 to 10 column volumes of elution buffer. Collect the fractions and check separately for purified protein. Pool those fractions containing the GST-tagged target protein.



## High-throughput screening using GST MultiTrap 4B 96-well filter plates

GST MultiTrap 4B (Fig 5.4) is a prepacked, disposable 96-well filter plate for reproducible, high-throughput screening of GST-tagged proteins. Typical applications include expression screening of different constructs, screening for solubility of proteins, and optimization of the conditions for small-scale parallel purification. These filter plates simplify the purification screening and enrichment of up to 0.5 mg of GST-tagged proteins/well. After thorough cell disruption, it is possible to apply up to 600  $\mu\text{L}$  of unclarified lysate directly to the wells in the 96-well filter plate without precentrifugation and/or filtration of the sample. It is recommended to extend the duration of mechanical/chemical lysis if the sample is too viscous after lysis; alternatively, include nucleases to disrupt nucleic acids. The GST-tagged proteins are eluted under mild, nondenaturing conditions that preserve protein structure and function.

The plates are packed with the AC media Glutathione Sepharose 4 Fast Flow (4% highly cross-linked agarose beads) and Glutathione Sepharose 4B (4% agarose beads), respectively. Each well contains 500  $\mu\text{L}$  of a 10% slurry of Glutathione Sepharose 4 Fast Flow or Glutathione Sepharose 4B in storage solution (50  $\mu\text{L}$  of medium in 20% ethanol). Note that binding depends on flow and may vary between proteins. Incubation of the sample with medium is needed, and optimization for ideal binding of the GST-tagged protein is recommended.

The 96-well filter plates with 800  $\mu\text{L}$  wells are made of polypropylene and polyethylene. Characteristics of GST MultiTrap 4B are listed in Appendix 2.

Prepacked GST MultiTrap 4B plates give high consistency in reproducibility well-to-well and plate-to-plate. The repeatability of yield and purity of eluted protein is high. Automated robotic systems as well as manual handling using centrifugation or vacuum pressure can be used. The purification protocol can easily be scaled up because Glutathione Sepharose is available in larger prepacked formats: GST GraviTrap, GSTrap FF, and GSTrap 4B (1 mL and 5 mL columns) and GSTPrep FF 16/10 (20 mL column).

See later in this chapter for a discussion of these products.



**Fig 5.4.** GST MultiTrap 4B 96-well filter plates.

## Sample preparation

- Adjust the sample to the composition and pH of the binding buffer by additions from concentrated stock solutions; by diluting the sample with binding buffer; or by buffer exchange.
- After thorough cell disruption, it is possible to apply unclarified lysate directly to the wells without precentrifugation and/or filtration of the sample. Apply the unclarified lysate to the wells directly after preparation, as the lysate may precipitate unless used immediately or frozen before use. New lysing of the sample can then prevent clogging of the wells when loading the plate.
- Lysis with commercial kits could give large cell debris particles that may interfere with drainage of the wells during purification. This problem can be solved by centrifugation or filtration of the sample before adding it to the wells.

## Buffer preparation

- Use high-purity water and chemicals, and pass all buffers through a 0.45 µm filter before use.

Binding buffer: PBS (140 mM NaCl, 2.7 mM KCl, 10 mM Na<sub>2</sub>HPO<sub>4</sub>, 1.8 mM KH<sub>2</sub>PO<sub>4</sub>), pH 7.3

Elution buffer: 50 mM Tris-HCl, 10 mM reduced glutathione, pH 8.0

- 1 to 20 mM DTT can be included in the binding and elution buffers to reduce the risk of oxidation of free -SH groups on GST, which may cause aggregation of the tagged target protein, resulting in lower yield of GST-tagged protein.

## Centrifugation procedure for high-throughput screening

### Preparing the filter plate

1. Peel off the bottom seal from the 96-well filter plate. Be sure to hold the filter plate over a sink to accommodate any leakage of storage solution when removing the bottom seal.
2. Hold the filter plate upside down and gently shake it to dislodge any medium adhering to the top seal. Return the filter plate to an upright position.
3. Place the filter plate against the bench surface and peel off the top seal.

*Note: If the medium has dried out in one or several wells, add buffer to rehydrate it. The performance of the medium is not affected.*

4. Position the filter plate on top of a collection plate.

*Note: Remember to change or empty the collection plate as necessary during the following steps.*

5. Centrifuge the filter plates for 2 min at 500 × g, to remove the storage solution from the medium.
6. Add 500 µL of deionized water/well. Centrifuge for 2 min at 500 × g.
7. Add 500 µL of binding buffer/well, and mix briefly to equilibrate the medium. Centrifuge for 2 min at 500 × g. Repeat once.



## Centrifugation procedure



Do not apply more than  $700 \times g$  during centrifugation.

1. Apply unclarified or clarified lysate (maximum  $600 \mu\text{L}$  per well) to the wells of the filter plate and incubate for 3 min.

*Note: If the yield of protein is too low, increase the incubation time and/or gently agitate the filter plate to effect mixing.*

2. Centrifuge the plate at  $100 \times g$  for 4 min or until all the wells are empty. Discard the flowthrough.
3. Add  $500 \mu\text{L}$  of binding buffer per well to wash out any unbound sample. Centrifuge at  $500 \times g$  for 2 min. Repeat once or until all unbound sample is removed.

*Note: Removal of unbound material can be monitored as  $A_{280}$ . For high purity,  $A_{280}$  should be  $< 0.1$ .*

4. Add  $200 \mu\text{L}$  of elution buffer per well and mix for 1 min.

*Note: The volume of elution buffer can be varied ( $50 \mu\text{L}$  to  $100 \mu\text{L}$  per well), depending on the concentration of target protein required. Volumes in the collection plate that are too small may give inaccurate absorbance values.*

5. Change the collection plate and centrifuge at  $500 \times g$  for 2 min to collect the eluted protein. Repeat twice or until all of the target protein has been eluted.

*Note: The yield can usually be monitored for each fraction as  $A_{280}$  reading. If uncertain of required volume, change the collection plate between each elution to prevent unnecessary dilution of the target protein.*



If the yield of eluted target protein is low, the incubation time can be increased.

## Vacuum procedure for high-throughput screening



If problems with foaming, reproducibility, or bubbles in the collection plate occur using vacuum, the centrifugation procedure should be considered. The distance between the filter plate and the collection plate is critical and should be kept small ( $\sim 5 \text{ mm}$ ); adjust the distance if necessary.

1. Peel off the bottom seal from the 96-well filter plate. Be sure to hold the filter plate over a sink to accommodate any leakage of storage solution when removing the bottom seal.
2. Hold the filter plate upside down and gently shake it to dislodge any medium adhering to the top seal. Return the filter plate to an upright position.
3. Place the filter plate against the bench surface and peel off the top seal.

*Note: If the medium has dried out in one or several wells, add buffer to rehydrate it. The performance of the medium is not affected.*

4. Position the filter plate on top of a collection plate.



*Note: Remember to change or empty the collection plate as necessary during the following steps.*

5. Set the vacuum to  $-0.15 \text{ bar}$ . Place the filter plate and collection plate on the vacuum manifold to remove the ethanol storage solution from the medium.
6. Add  $500 \mu\text{L}$  of deionized water to each well. Apply a vacuum to remove the water from the wells.
7. Add  $500 \mu\text{L}$  of binding buffer to each well to equilibrate the medium. Apply a vacuum as in step 5. Repeat this step once. The filter plate is now ready for use.




## Preparing the filter plate


### Vacuum procedure

-  If a robotic system is used for purification, the vacuum must be adjusted according to methods applicable to the system.
-  Do not apply a pressure in excess of -0.5 bar during vacuum operation.

1. Apply unclarified or clarified lysate (maximum 600  $\mu\text{L}$  per well) to the wells of the filter plate and incubate for 3 min.  
*Note: If the yield of protein is too low, increase the incubation time and/or gently agitate the filter plate.*
2. Apply a vacuum of -0.15 bar until all the wells are empty. Slowly increase the vacuum to -0.30 bar and turn off the vacuum after approximately 5 s. Discard the flowthrough.

-  Increasing the vacuum too quickly can result in foaming under the filter plate and subsequent cross-contamination of samples.

3. Add 500  $\mu\text{L}$  of binding buffer per well to wash out any unbound sample. Remove the solution as in step 2. Repeat once or until all unbound sample is removed.  
*Note: Removal of unbound material can be monitored as  $A_{280}$ . For high purity,  $A_{280}$  should be  $< 0.1$ .*
4. Add 200  $\mu\text{L}$  of elution buffer per well and mix for 1 min.  
*Note: The volume of elution buffer can be varied (50  $\mu\text{L}$  to 100  $\mu\text{L}$  per well), depending on the concentration of target protein required.*
5. Change the collection plate and apply vacuum as in step 2 to collect the eluted protein. Repeat twice or until all of the target protein has been eluted.  
*Note: The yield can usually be monitored for each fraction as  $A_{280}$  reading. If uncertain of required volume, change the collection plate between each elution to prevent unnecessary dilution of the target protein.*

-  If the yield of eluted target protein is low, the incubation time can be increased.

## Minipreps using GST SpinTrap

GST SpinTrap columns are designed for rapid, small-scale purification of GST-tagged proteins using conditions of mild affinity purification. Greater than 90% purity can be achieved in a single step. The columns are suitable for purification of multiple samples in parallel, for example, expression screening experiments or optimization of purification conditions.



Each microspin column contains 50  $\mu\text{L}$  of Glutathione Sepharose 4B, enough to purify up to 500  $\mu\text{g}$  of recombinant GST (rGST). The capacity will vary with the nature of the GST-tagged protein and the binding conditions used. Refer to Appendix 2 for the main characteristics of GST SpinTrap.



**Fig. 5.5.** GST SpinTrap is a single-use column for rapid, small-scale purification of GST-tagged proteins.

## Sample preparation

For small-scale cultures, freeze/thaw or chemical lysis with commercial kits are recommended for cell lysis. Cytiva can provide lysis kits for different expression systems: Mammalian Protein Extraction Buffer for mammalian expression systems and Yeast Protein Extraction Buffer Kit for yeast expression systems. For bacteria, several chemical lysis kits are available on the market.

-  Adjust the sample to the composition and pH of the binding buffer by additions from concentrated stock solutions; by diluting the sample with binding buffer; or by buffer exchange.
-  Pass the sample through a 0.22 µm or a 0.45 µm filter, and/or centrifuge it immediately before sample application. If the sample is too viscous, dilute it with binding buffer to prevent it from clogging; increase lysis treatment (sonication, homogenization); or add DNase/RNase to reduce the size of nucleic acid fragments.


Note: Cell culture lysates may also be directly applied to the column without prior clarification.

## Buffer preparation

Recommended buffers can easily be prepared from GST Buffer Kit.

Binding buffer: 10 mM PBS, pH 7.4 (10 mM Na<sub>2</sub>HPO<sub>4</sub>, 140 mM NaCl, 2.7 mM KCl, 1.8 mM KH<sub>2</sub>PO<sub>4</sub> pH 7.4)

Elution buffer: 50 mM Tris-HCl, 10 to 20 mM reduced glutathione, pH 8.0


-  1 to 20 mM DTT may be included in the binding and elution buffers to reduce the risk of oxidation of free -SH groups on GST, which may cause aggregation of the tagged target protein, resulting in lower yield of GST-tagged protein.

## Purification

The capacity of each SpinTrap column is 500 µg of GST-tagged protein. A maximum of 600 µL of culture lysate or buffer can be applied to a SpinTrap column. This represents roughly a volume of lysate produced from a 12 mL culture. The following procedure is designed for lysates prepared from 2 to 12 mL of culture.

Perform purifications on GST SpinTrap using a standard microcentrifuge. Place the column in a 2 mL microcentrifuge tube to collect the liquid during centrifugation. Use a new 2 mL tube for every step (steps 1 to 5).

1. Invert and shake the column repeatedly to resuspend the medium. Loosen the top cap one-quarter of a turn and twist/break off the bottom closure. Place the column in a 2 mL microcentrifuge tube and centrifuge for 30 s at 100 × g (approx. 1500 rpm in an Eppendorf 5415R, 24-position fixed-angle rotor) to remove the storage liquid.
2. Remove and discard the top cap. Equilibrate the column by adding 600 µL of binding buffer. Centrifuge for 30 s at 100 × g.
3. Add the sample (see Sample preparation). The maximum sample volume is 600 µL per column. Centrifuge for 30 s at 100 × g. Mix gently at room temperature for 5 to 10 min to ensure optimal binding of GST-tagged proteins to the Glutathione Sepharose 4B medium.

-  It is possible to make several sample applications as long as the binding capacity of the column is not exceeded.

4. Wash with 600 µL of binding buffer. Centrifuge for 30 s at 100 × g. Repeat the wash step once.
5. Elute the target protein twice with 200 µL of elution buffer. Centrifuge for 30 s at 100 × g, and collect the purified sample. The first 200 µL will contain the majority of the target protein.

-  Yields of GST-tagged protein may be increased by repeating the elution step two or three times and pooling all eluates.



## Gravity-flow purification using GST GraviTrap

GST GraviTrap is designed for fast and simple purification of GST-tagged proteins using gravity flow. The column is prepacked with 2 mL of Glutathione Sepharose 4B, enough to purify up to 50 mg of rGST. The capacity will vary with the nature of the tagged protein and the binding conditions used. Refer to Appendix 2 for the main characteristics of GST GraviTrap.

GST GraviTrap columns are delivered in a package that can be converted into a column stand to simplify purification. LabMate PD-10 Buffer Reservoir can be connected to the columns for convenient handling of sample volumes above 10 mL. For optimal performance, use GST GraviTrap with buffers prepared from GST Buffer Kit.

### Sample preparation

Refer to *General considerations for purification of GST-tagged proteins* for general considerations before beginning this procedure.

- Adjust the sample to the composition and pH of the binding buffer by additions from concentrated stock solutions; by diluting the sample with binding buffer; or by buffer exchange.
- Pass the sample through a 0.22  $\mu\text{m}$  or a 0.45  $\mu\text{m}$  filter, and/or centrifuge it immediately before sample application. If the sample is too viscous, dilute it with binding buffer to prevent it from clogging; increase lysis treatment (sonication, homogenization); or add DNase/RNase to reduce the size of nucleic acid fragments.

Note: Cell culture lysates may also be directly applied to the column without prior clarification.

### Buffer preparation

Recommended buffers can easily be prepared from GST Buffer Kit.

Binding buffer: 10 mM PBS, pH 7.4 (10 mM  $\text{Na}_2\text{HPO}_4$ , 140 mM NaCl, 2.7 mM KCl, 1.8 mM  $\text{KH}_2\text{PO}_4$ , pH 7.4)

Elution buffer: 50 mM Tris-HCl, 10 to 20 mM reduced glutathione, pH 8.0

- 1 to 20 mM DTT may be included in the binding and elution buffers to reduce the risk of oxidation of free -SH groups on GST, which may cause aggregation of the tagged target protein, resulting in lower yield of GST-tagged protein.



Fig 5.6. Purifying GST-tagged proteins with GST GraviTrap is a simple four-stage procedure.

### Purification

- Cut off the bottom tip. Remove the top cap and pour off excess liquid. Place the column in the Workmate column stand. If needed, mount LabMate (funnel) on the top of the column.
- Equilibrate the column with 10 to 20 mL of binding buffer to remove the preservative.
- Apply the sample to the column.
- Wash the column with 2 to 10 mL of binding buffer.
- Elute the bound material with 10 mL of elution buffer, and collect 1 to 2 mL fractions.

## Purification using GSTrap HP, GSTrap FF, and GSTrap 4B columns

GSTrap affinity columns are specially designed 1 mL and 5 mL HiTrap columns packed with Glutathione Sepharose High Performance, Glutathione Sepharose 4 Fast Flow, or Glutathione Sepharose 4B chromatography media. Refer to the selection guide in Table 5.1 for a summary of their differences and to Appendix 2 for a list of key characteristics of each.

Sample application, washing, and elution can be performed using a syringe with a supplied connector, a peristaltic pump, or a liquid chromatography system such as ÄKTA (see Table 2.1 in Chapter 2 for equipment choices). For easy scale-up, two to three columns can be connected together in series simply by screwing the end of one column into the top of the next.

Figure 5.7 shows a schematic representation of the simple steps needed for successful purification using GSTrap columns.

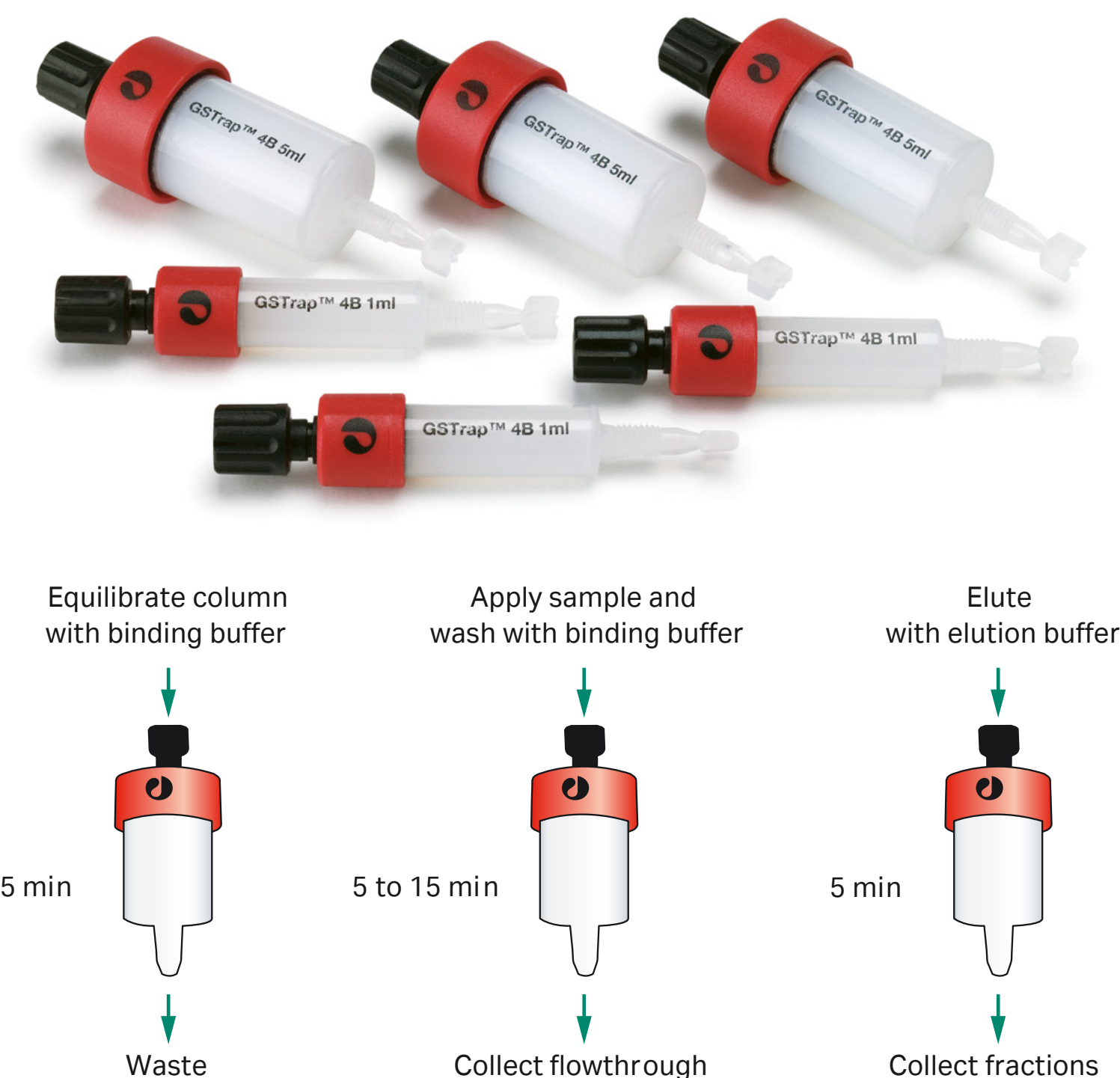
The GSTrap HP, FF, and 4B columns are made of polypropylene, which is biocompatible and non-interactive with biomolecules. The top and bottom frits are manufactured from porous polyethylene. Columns are delivered with a stopper on the inlet and a snap-off end on the outlet. Every package includes all necessary components for connection of the columns to different types of equipment. Note that GSTrap columns cannot be opened or refilled.

GSTrap columns are directly compatible with existing purification protocols for GST-tagged proteins, including on-column proteolytic cleavage methods. If removal of the GST moiety is required, the tagged protein can be digested with an appropriate site-specific protease while bound to the medium or, alternatively, after elution (see later in this chapter). On-column cleavage eliminates the extra step of separating the released protein from GST because the GST moiety remains bound.

One of the three media, Glutathione Sepharose 4 Fast Flow, is also available in prepacked 20 mL GSTPrep FF 16/10 columns. All three are available in bulk packs (varying from 10 to 500 mL) for packing in a column of the user's choice.

For cleaning, storage, and handling information, refer to Appendix 2.

The chromatography media are very stable and the purification process very reproducible. This can be seen from the results of an experiment in which *E. coli* homogenates containing GST-hippocalcin ( $M_r$  43 000) were repeatedly purified 10 times on the same column without cleaning between runs. The 10 overlaid chromatograms (Fig 5.8A) show a near perfect match, indicating little or no variation in binding capacity and stability of the medium. SDS-PAGE analysis (Fig 5.8B) also indicates no changes in purity or binding capacity after 10 runs.



**Fig 5.7.** GSTrap HP, GSTrap 4B, and GSTrap FF 1 mL and 5 mL columns allow convenient and simple one-step purification of GST-tagged proteins. Simple purification of GST-tagged proteins is shown at bottom.



## Sample preparation

Refer to *General considerations for purification of GST-tagged proteins* for general considerations before beginning this procedure.

- Adjust the sample to the composition and pH of the binding buffer by additions from concentrated stock solutions; by diluting the sample with binding buffer; or by buffer exchange.
- Pass the sample through a 0.22  $\mu\text{m}$  or a 0.45  $\mu\text{m}$  filter and/or centrifuge it immediately before sample application. If the sample is too viscous, dilute it with binding buffer to prevent it from clogging; increase lysis treatment (sonication, homogenization); or add DNase/RNase to reduce the size of nucleic acid fragments.

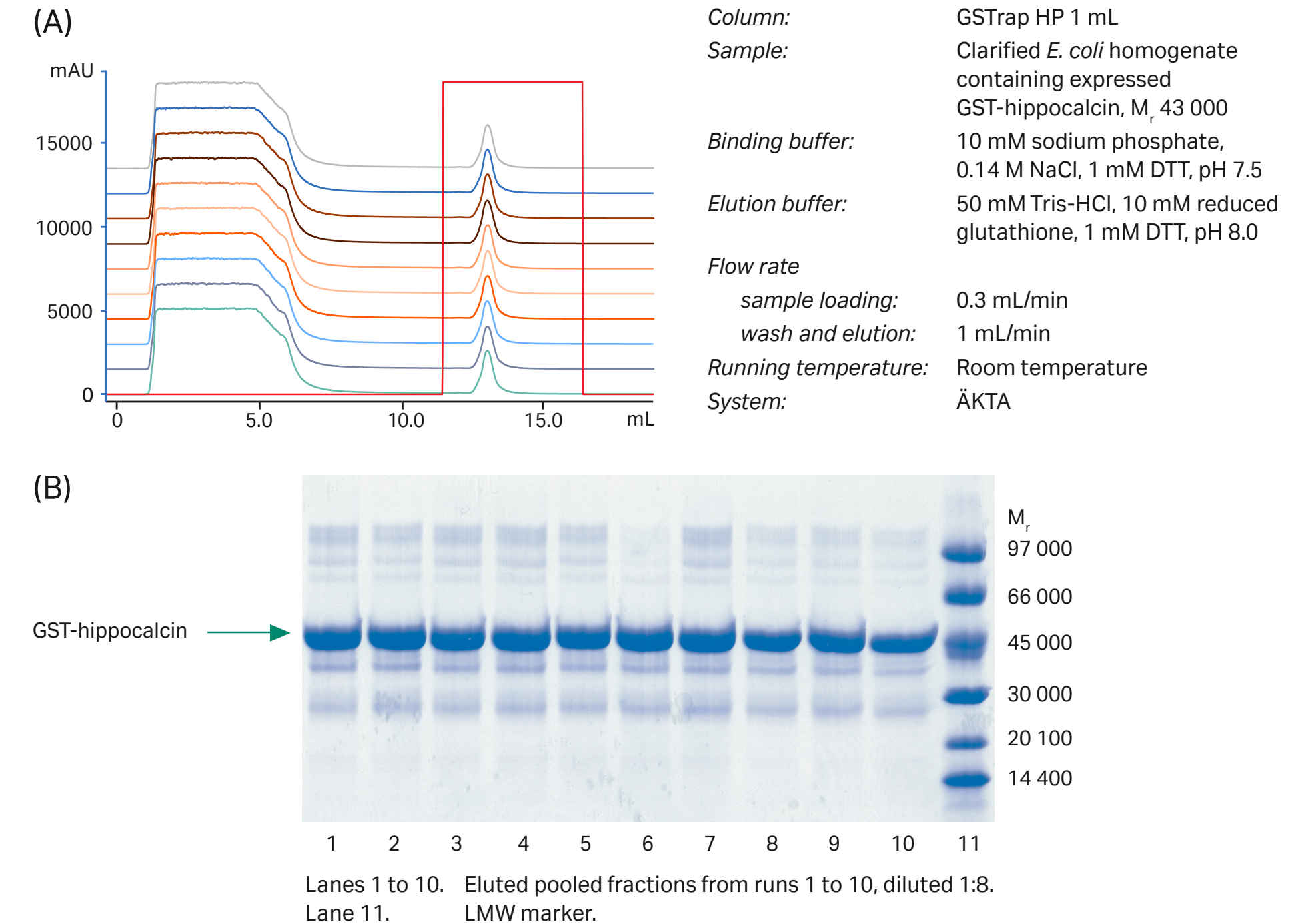
## Buffer preparation

- Use high-purity water and chemicals, and pass all buffers through a 0.45  $\mu\text{m}$  filter before use.

Binding buffer: PBS (140 mM NaCl, 2.7 mM KCl, 10 mM  $\text{Na}_2\text{HPO}_4$ , 1.8 mM  $\text{KH}_2\text{PO}_4$ ), pH 7.3

Elution buffer: 50 mM Tris-HCl, 10 to 20 mM reduced glutathione, pH 8.0

- 1 to 20 mM DTT may be included in the binding and elution buffers to reduce the risk of oxidation of free -SH groups on GST, which may cause aggregation of the tagged target protein, resulting in lower yield of GST-tagged protein.



**Fig 5.8.** (A) Confirmation of the stability of Glutathione Sepharose High Performance prepacged in 1 mL GSTrap HP columns. Chromatographic overlay of 10 repetitive purifications. (B) Coomassie-stained nonreduced SDS-polyacrylamide gel (ExcelGel SDS Gradient 8–18) of pooled fractions from repetitive purification runs shown in (A).



## Purification

1. Fill the syringe or pump tubing with binding buffer. Remove the stopper and connect the column to the syringe (use the connector supplied), laboratory pump, or chromatographic system "drop to drop" to avoid introducing air into the column.
2. Remove the snap-off end at the column outlet.
3. Equilibrate the column with 5 column volumes of binding buffer.
4. Apply the pretreated sample using a syringe fitted to the Luer connector or by pumping it onto the column. For best results, use a flow rate of 0.2 to 1 mL/min (1 mL column) and 0.5 to 5 mL/min (5 mL column) during sample application<sup>1</sup>.
5. Wash with 5 to 10 column volumes of binding buffer or until no material appears in the effluent. Maintain a flow rate of 1 to 2 mL/min (1 mL column) and 5 to 10 mL/min (5 mL column) for washing.

Optional: Collect the flowthrough (in 1 mL fractions for the 1 mL column and 2 mL fractions for the 5 mL column) and reserve until the procedure has been successfully completed. Retain a sample for analysis by SDS-PAGE or by CDNB assay to check for any loss of unbound target protein.


6. Elute with 5 to 10 column volumes of elution buffer. Maintain a flow rate of 0.2 to 1 mL/min (1 mL column) and 0.5 to 5 mL/min (5 mL column) for elution.
7. After elution, regenerate the column by washing it with 3 to 5 column volumes of binding buffer. The column is now ready for a new purification.


<sup>1</sup> One mL/min corresponds to approximately 30 drops/min when using a syringe with a HiTrap 1 mL column, and 5 mL/min corresponds to approximately 120 drops/min when using a HiTrap 5 mL column.



**Fig 5.9.** Using a GSTrap column with a syringe. (A) Prepare buffers and sample. Remove the column's top cap and snap off the end. (B) Load the sample and begin collecting fractions. (C) Wash and elute, continuing to collect fractions.

Volumes and times used for elution may vary among tagged proteins. Additional elutions with higher concentrations of glutathione may be required. Flowthrough, wash, and eluted material from the column should be monitored for GST-tagged proteins using SDS-PAGE in combination with Western blotting, if necessary.

 Flow rate will affect the binding and elution of GST-tagged proteins to the chromatography medium. Due to the relatively slow binding kinetics between GST and glutathione, it is important to keep the flow rate low for maximum binding capacity. Protein characteristics, pH, and temperature are other factors that may affect the binding capacity. However, when working with sensitive proteins, higher flow rates are recommended to minimize purification time. Combining two or three columns in tandem would increase residence time for sample passing the column, thus allowing higher flow rates to be used.

 The reuse of GSTrap HP, FF, or 4B columns depends on the nature of the sample and should only be performed with identical samples to prevent cross-contamination.

## Application examples

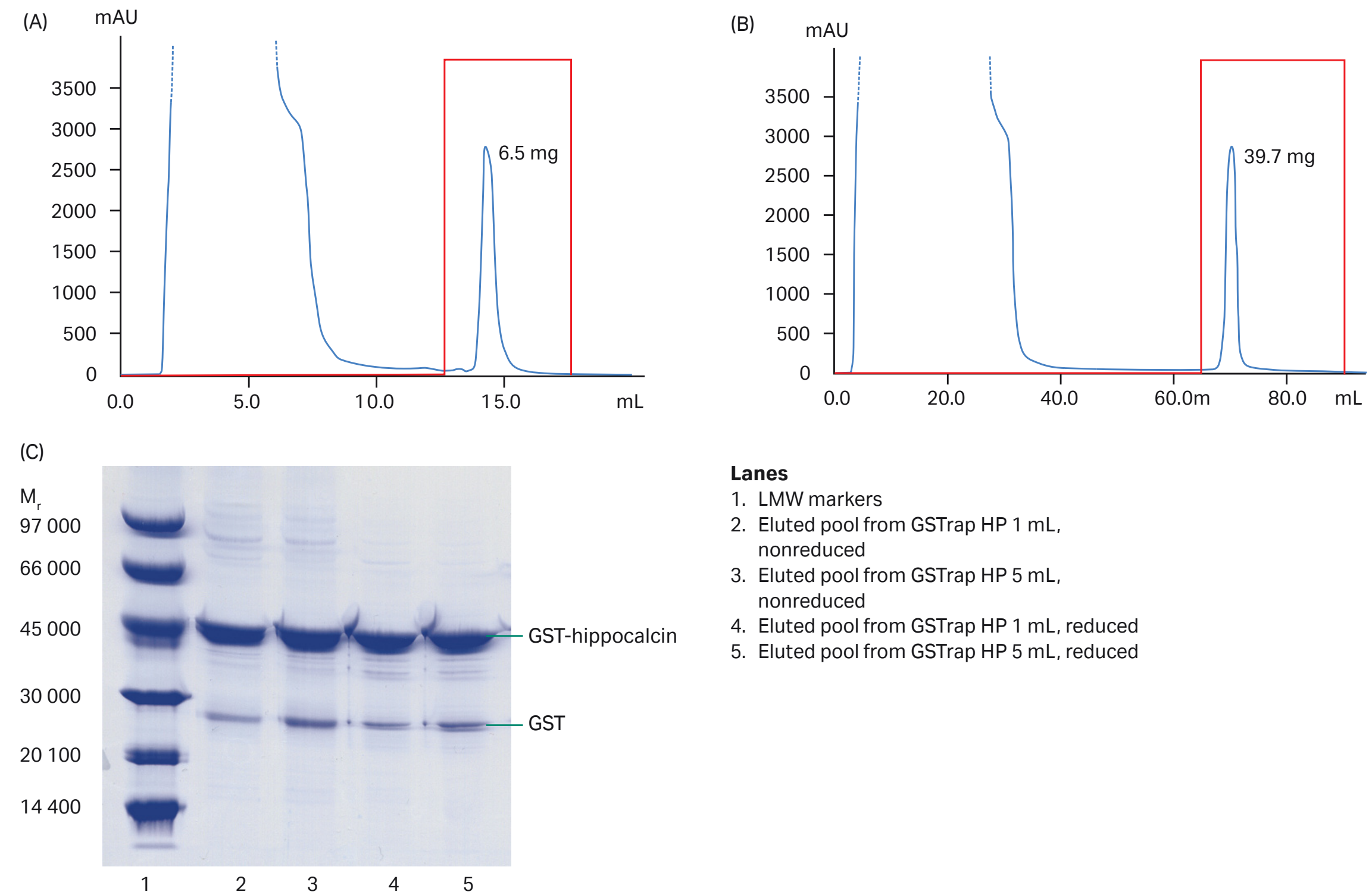
### 1. High-performance purification of GST-hippocalcin using 1 mL and 5 mL GSTrap HP columns

Glutathione Sepharose High Performance is easy to use for one-step purification of GST-tagged proteins. The following data show the results from experiments using both GSTrap HP 1 mL and 5 mL.

In this study, 5 mL and 25 mL of *E. coli* homogenate containing GST-hippocalcin was loaded on GSTrap HP 1 mL and 5 mL columns, respectively. Figure 5.10A–B shows the chromatograms from the two runs. The amount of protein in the eluted peaks was calculated as 6.5 mg and 39.7 mg, respectively.

The SDS-PAGE analysis showed GST-hippocalcin analyzed under nonreducing and reducing buffer conditions (Fig 5.10C). Each well was loaded with 10  $\mu$ g of protein. The SDS-PAGE analysis also showed that free GST was expressed. The presence of reducing agent led to the removal of high-molecular-weight bands, which may correspond to GST-tagged protein that is associated by oxidation of the free sulfhydryl groups.

Columns:	GSTrap HP 1 mL and GSTrap HP 5 mL
Sample:	Clarified <i>E. coli</i> homogenate containing expressed GST-hippocalcin, $M_r$ 43 000
Sample volumes:	GSTrap HP 1 mL: 5 mL 5 mL: 25 mL
Binding buffer:	10 mM sodium phosphate, 0.14 M NaCl, pH 7.4
Elution buffer:	50 mM Tris-HCl, 10 mM reduced glutathione, pH 8.0
Flow rate	
sample loading:	GSTrap HP 1 mL: 0.3 mL/min 5 mL: 1.6 mL/min
wash and elution:	GSTrap HP 1 mL: 1 mL/min 5 mL: 4 mL/min
Running temperature:	Room temperature
System:	ÄKTA



**Fig 5.10.** Scale-up from (A) GSTrap HP 1 mL to (B) GSTrap HP 5 mL. (C) Coomassie-stained reduced and nonreduced SDS-polyacrylamide gel (ExcelGel SDS Gradient 8–18) of fractions from purification shown in Fig 5.10A–B.

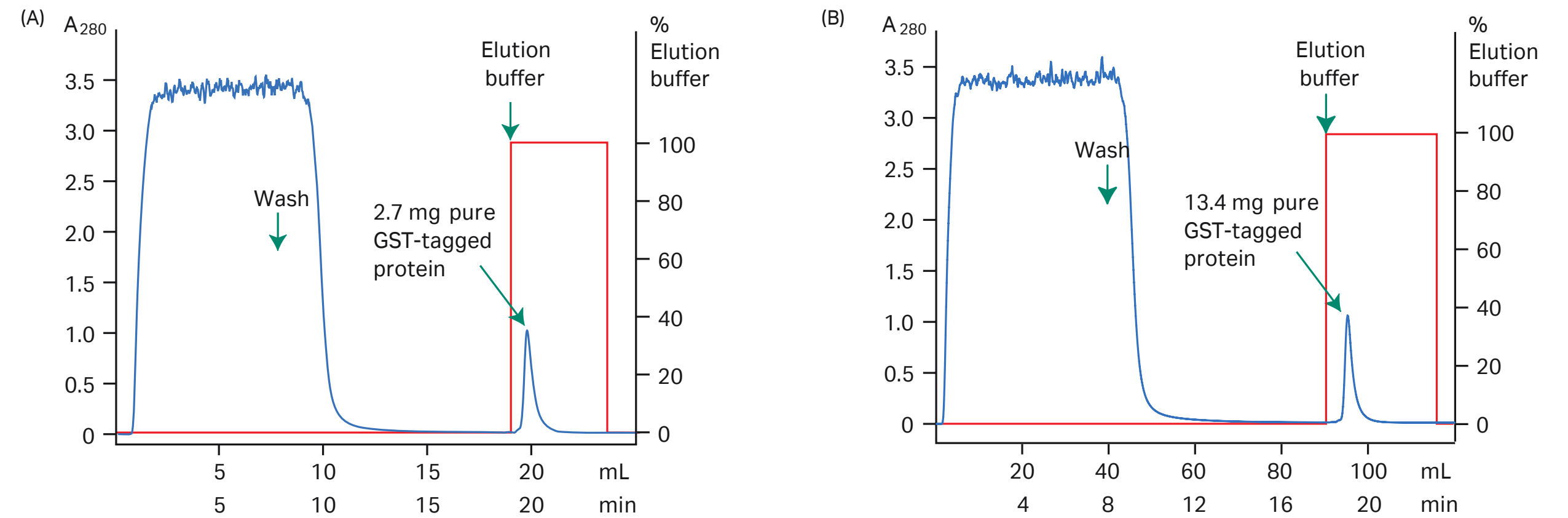


## 2. Fast purification of a GST-tagged protein using GSTrap FF 1 mL and 5 mL columns

A GST-tagged protein was purified from 8 mL and 40 mL of a clarified cell lysate using GSTrap FF 1 mL and 5 mL columns, respectively. Samples were applied to columns pre-equilibrated with PBS (pH 7.3). After washing the columns with 10 column volumes of PBS, GST-tagged protein was eluted using reduced glutathione (Fig 5.11). Each run was completed in 25 min. Analysis by SDS-PAGE indicated the isolation of highly pure GST-tagged protein (not shown). Yields of tagged proteins were 2.7 mg from GSTrap FF 1 mL and 13.4 mg from GSTrap FF 5 mL.

Sample: 8 mL clarified *E. coli* lysate  
 Column: GSTrap FF 1 mL  
 Binding buffer: PBS (150 mM NaCl, 20 mM phosphate buffer, pH 7.3)  
 Elution buffer: 10 mM reduced glutathione, 50 mM Tris-HCl, pH 8.0  
 Flow rate: 1 mL/min  
 Chromatographic procedure: 4 column volumes (CV) binding buffer, 8 mL sample, 10 CV binding buffer, 5 CV elution buffer, 5 CV binding buffer  
 System: ÄKTA

Sample: 40 mL clarified *E. coli* lysate  
 Column: GSTrap FF 5 mL  
 Binding buffer: PBS (150 mM NaCl, 20 mM phosphate buffer, pH 7.3)  
 Elution buffer: 10 mM reduced glutathione, 50 mM Tris-HCl, pH 8.0  
 Flow rate: 5 mL/min  
 Chromatographic procedure: 4 column volumes (CV) binding buffer, 40 mL sample, 10 CV binding buffer, 5 CV elution buffer, 5 CV binding buffer  
 System: ÄKTA



**Fig 5.11.** Purification of a GST-tagged protein on GSTrap FF 1 mL and 5 mL columns. Cytoplasmic extract (8 and 40 mL) from *E. coli* expressing a GST-tagged protein were applied to GSTrap FF 1 mL (A) and GSTrap FF 5 mL (B), respectively.



### 3. Two-step, automated purification using ÄKTExpress

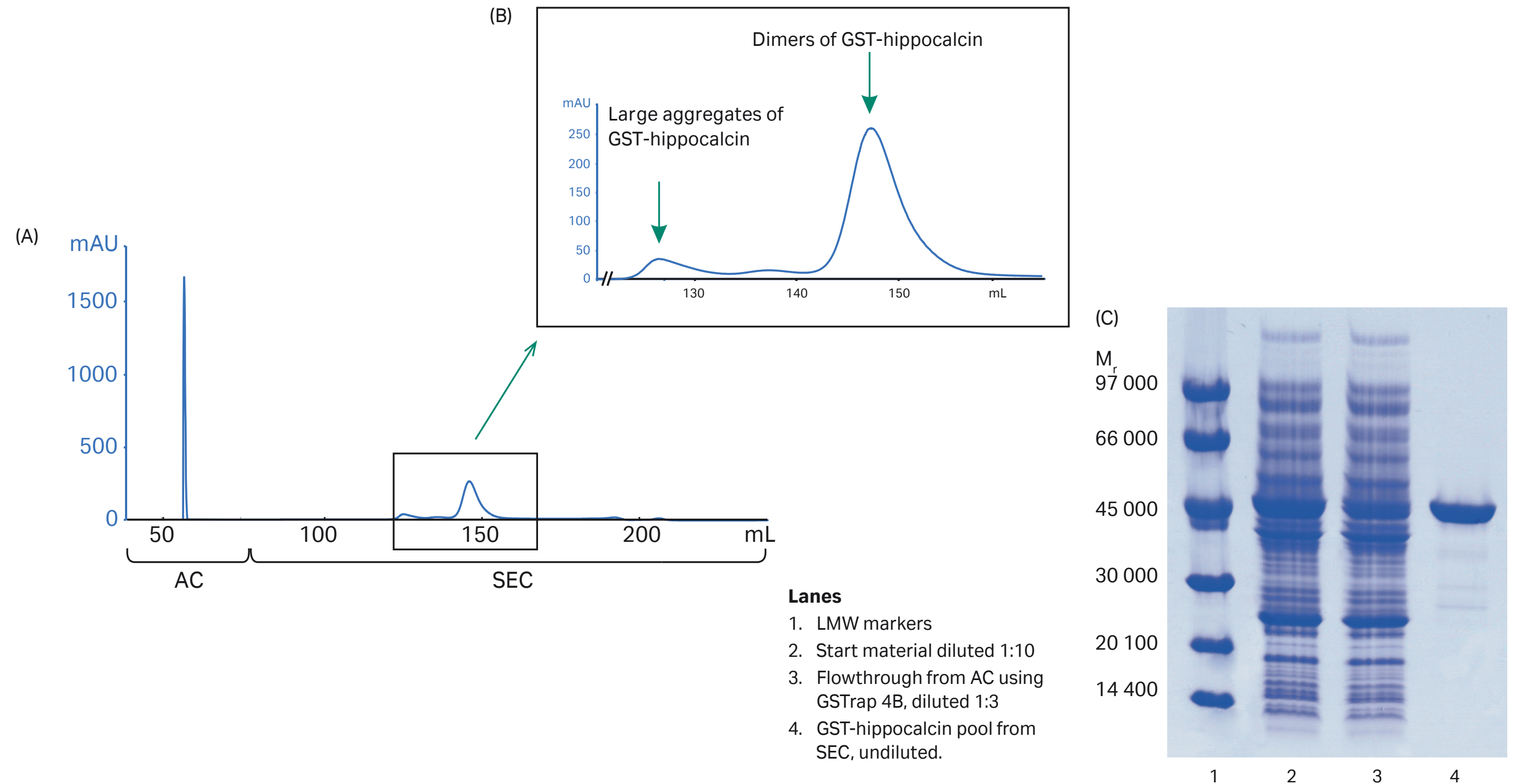
A two-step, automated purification of GST-hippocalcin from clarified *E. coli* lysate was performed on ÄKTExpress. GSTrap 4B 1 mL column was used in the first AC capture step and a HiLoad 16/60 Superdex 200 pg column for the SEC polishing step.

Reducing agent (DTT) was included in both sample and buffers. ÄKTExpress enabled automated loading of eluted fractions of the target protein from the capture step (GSTrap 4B) onto the SEC column. Lysis of *E. coli* containing GST-hippocalcin was performed enzymatically followed by sonication. The lysate was clarified by centrifugation and filtration, and 5 mL of the clarified lysate was loaded on the 1 mL GSTrap 4B column. Chromatograms from the automated two-step purification, as well as SDS-PAGE of the eluted pool of target protein, are shown in Figure 5.12. Two peaks were obtained after SEC (Fig 12B): one small and one large. The small peak was possibly aggregates, and the large peak seemed to be dimers of GST-hippocalcin. Evaluation by SDS-PAGE indicated that both peaks contained GST-hippocalcin. The purity of the GST-hippocalcin in the major fraction was good (Fig 5.12C).

Yield of eluted GST-hippocalcin, determined by absorbance at 280 nm using UNICORN software, was 6.4 mg.

This application shows the benefit of using a two-step purification for increasing the purity of GST-hippocalcin.

Columns:	GSTrap 4B, 1 mL HiLoad 16/60 Superdex 200 pg, 120 mL
Sample:	Clarified <i>E. coli</i> lysate containing expressed GST-hippocalcin, $M_r$ 43 000
Sample volume:	5 mL (GSTrap 4B)
Binding buffer:	10 mM sodium phosphate, 140 mM NaCl, 20 mM DTT, pH 7.4
Elution buffer:	50 mM Tris-HCl, 20 mM glutathione, 20 mM DTT, pH 8.0
Buffer SEC:	10 mM sodium phosphate, 140 mM NaCl, 20 mM DTT, pH 7.4
Flow rate:	Sample loading, 0.3 mL/min (GSTrap 4B); Wash and elution, 1 mL/min (GSTrap 4B); 1.5 mL/min (HiLoad 16/60 Superdex 200 pg)
Running temperature:	22°C
System:	ÄKTExpress



**Fig 5.12.** (A) Purification of GST-hippocalcin from *E. coli* lysate using an automated two-step purification on ÄKTExpress. (B) Enlargement of the peak from the SEC step revealed large aggregates and dimers of purified GST-hippocalcin. (C) SDS-PAGE (ExcelGel SDS Gradient 8–18%) showing final purity of GST-hippocalcin (lane 4).

## Preparative purification using GSTPrep FF 16/10 column

GSTPrep FF 16/10 columns are based on the 20 mL HiPrep column design, ready to use for easy, one-step preparative purification of GST-tagged proteins, other glutathione S-transferases, and glutathione binding proteins. Prepacked with Glutathione Sepharose 4 Fast Flow, the columns exhibit high binding capacity and excellent flow properties. For easy scale-up, columns can be connected in series.

The column is made of polypropylene, which is biocompatible and noninteractive with biomolecules. Separations can be easily achieved using a chromatography system such as ÄKTA. Refer to Table 2.1 in Chapter 2 for a selection guide to purification equipment and to Appendix 2 for a list of GSTPrep FF 16/10 column parameters.

Glutathione Sepharose 4 Fast Flow is also available as prepacked 1 mL and 5 mL GSTrap FF columns, and as a bulk medium in bulk packs (25, 100, and 500 mL) for packing columns or batch purifications. Note that GSTPrep FF 16/10 columns cannot be opened or refilled.

### Sample preparation

Refer to *General considerations for purification of GST-tagged proteins* for general considerations before beginning this procedure.

- Adjust the sample to the composition and pH of the binding buffer by additions from concentrated stock solutions; by diluting the sample with binding buffer; or by buffer exchange.
- Pass the sample through a 0.22  $\mu\text{m}$  or a 0.45  $\mu\text{m}$  filter and/or centrifuge it immediately before sample application. If the sample is too viscous, dilute it with binding buffer to prevent it from clogging; increase lysis treatment (sonication, homogenization); or add DNase/RNase to reduce the size of nucleic acid fragments.

### Buffer preparation

- Use high-purity water and chemicals, and pass all buffers through a 0.45  $\mu\text{m}$  filter before use.

Binding buffer: PBS (140 mM NaCl, 2.7 mM KCl, 10 mM  $\text{Na}_2\text{HPO}_4$ , 1.8 mM  $\text{KH}_2\text{PO}_4$ ), pH 7.3

Elution buffer: 50 mM Tris-HCl, 10 mM reduced glutathione, pH 8.0

- 1 to 20 mM DTT may be included in the binding and elution buffers to reduce the risk of oxidation of free -SH groups on GST, which may cause aggregation of the tagged target protein, resulting in lower yield of GST-tagged protein.





Fig 5.13. GSTPrep FF 16/10 column.




## Purification

1. Apply the centrifuged and/or filtered sample (in binding buffer) to the column at a flow rate of 1 to 5 mL/min (30 to 150 cm/h).
2. Wash the column with 100 to 200 mL of binding buffer at 2 to 10 mL/min (60 to 300 cm/h).
3. Elute the bound protein with 100 to 200 mL of elution buffer at a flow rate of 2 to 10 mL/min (60 to 300 cm/h).
4. Equilibrate the column with 60 to 100 mL of binding buffer at a flow rate of 2 to 10 mL/min (60 to 300 cm/h). The column is now ready for a new purification.

 Due to the relatively slow binding kinetics between GST and glutathione, it is important to keep the flow rate low during sample loading/elution. The binding capacity may be different for different proteins. The yield may therefore vary between proteins if sample load is close to the capacity of the column.

 Optional: Collect the flowthrough and reserve until the procedure has been successfully completed. Retain a sample for analysis by SDS-PAGE or by CDNB assay to check for any loss of unbound target protein.

 Reuse of any purification column depends on the nature of the sample and should only be performed with identical tagged proteins to prevent cross-contamination.

For cleaning, storage, and handling information, refer to Appendix 2.



## Application example

### Purification and scale-up of two GST-tagged proteins using 1 mL and 5 mL GSTrap FF columns and GSTPrep FF 16/10 column

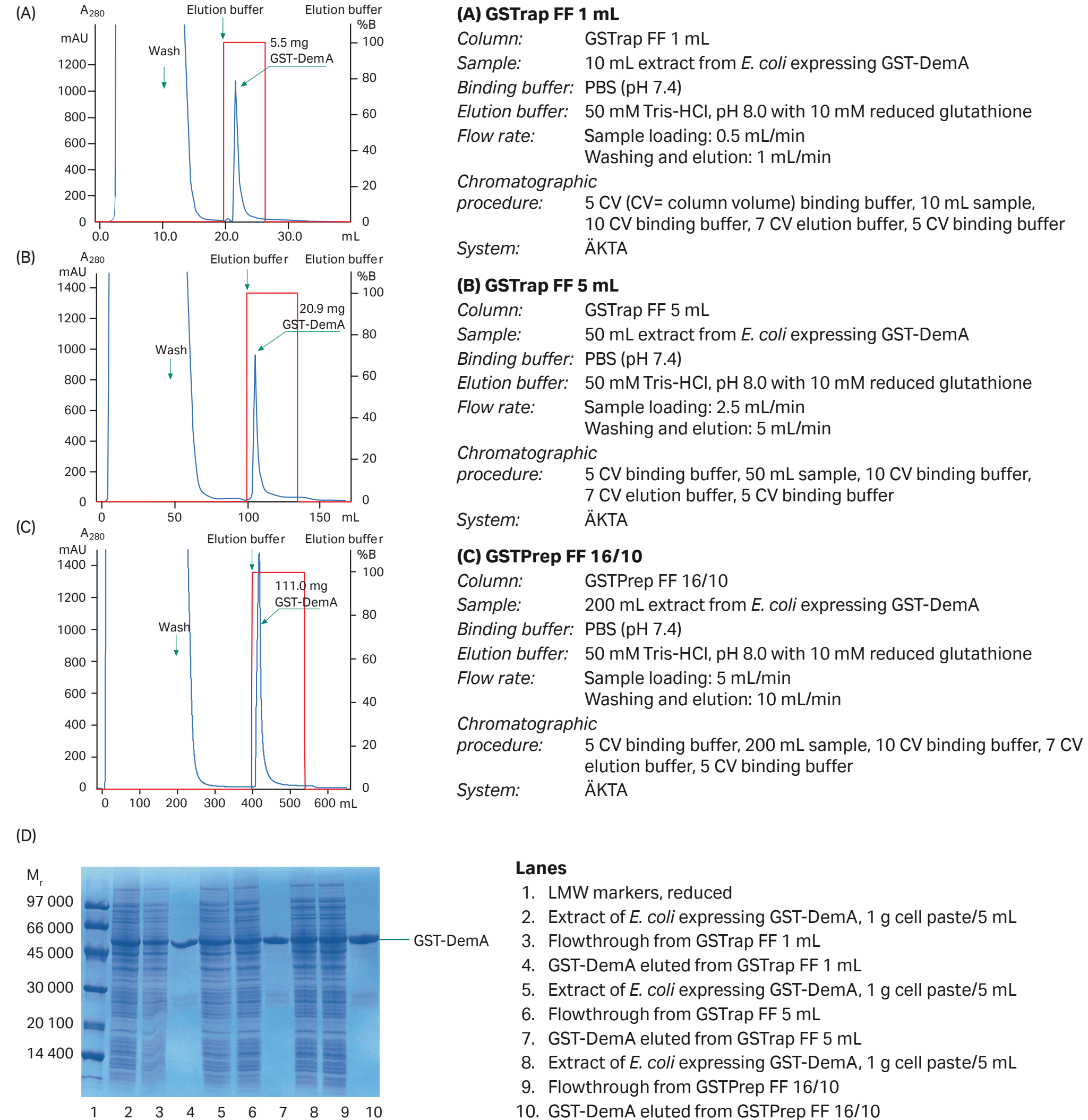
Glutathione Sepharose 4 Fast Flow is easy to use for one-step purification of GST-tagged proteins. Figures 5.14A-C and 5.15A-C show scale-up studies on GSTrap FF 1 mL, GSTrap FF 5 mL, and GSTPrep FF 16/10. Two different GST tagged proteins were purified: GST-DemA and GST-Pur $\alpha$ . The gene encoding for DemA was isolated from *Streptococcus dysgalactiae*. DemA is a fibrinogen-binding protein that shows both plasma protein binding properties and sequence similarities with the M and M-like proteins of other streptococcal species. Pur $\alpha$  has been shown to be involved in transcriptional regulation.

*E. coli* expressing the GST-tagged proteins was resuspended (1 g/5 mL) in PBS (140 mM NaCl, 2.7 mM KCl, 10 mM Na<sub>2</sub>HPO<sub>4</sub>, 1.8 mM KH<sub>2</sub>PO<sub>4</sub>, pH 7.4) supplemented with 1 mM PMSF, 1 mM DTT, 100 mM MgCl<sub>2</sub>, 1 U/mL RNase A, and 13 U/mL DNase I. The cells were lysed by sonication with a Vibracell™ ultrasonic processor for 3 min, amplitude 50%. The cell extract was kept on ice during the sonication. Cell debris was removed by centrifugation at 48 000 × g, 4°C for 30 min. The supernatant was applied to the column after passage through a 0.45  $\mu$ m filter.

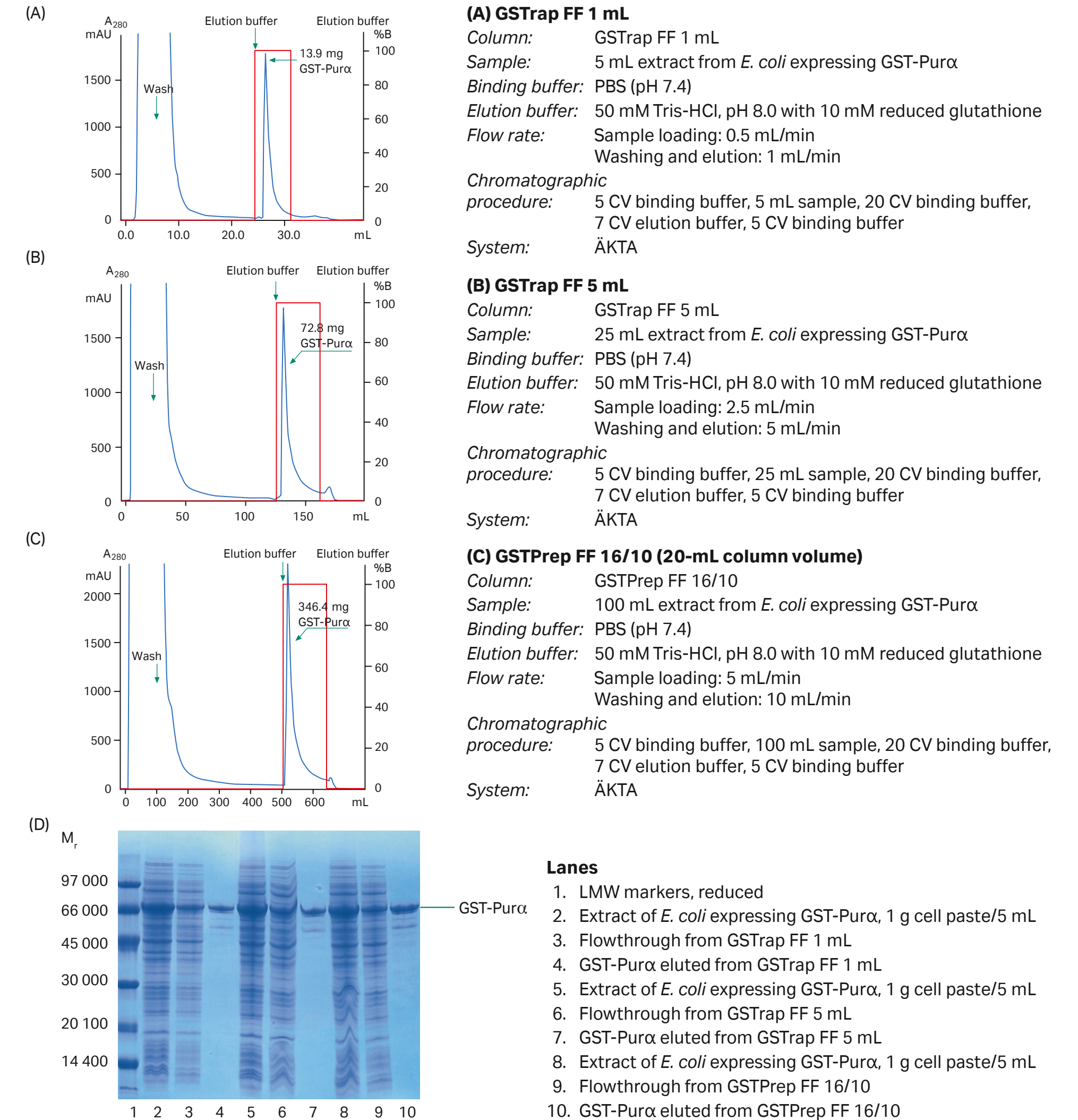
The following purification procedures were performed using an ÄKTA chromatography system. The columns, GSTrap FF 1 mL, GSTrap FF 5 mL, and GSTPrep FF 16/10 were equilibrated with 5 column volumes of PBS, pH 7.4, and the prepared sample was applied to the columns.

The columns were washed with 10 column volumes of PBS (GST-DemA) and 20 column volumes of (GST-Pur $\alpha$ ) and eluted using 7 column volumes of Tris-HCl, pH 8.0 including 10 mM reduced glutathione. The purity of eluted proteins was analyzed by SDS-PAGE (see Figs 5.14D and 5.15D).

The main parameter in this scale-up study was the residence time (i.e., the period of time the sample is in contact with the chromatography medium). The residence time was the same for the GSTrap FF 1 mL and 5 mL columns whereas it was twice as long for the GSTPrep FF 16/10 column (20 mL column volume) compared with GSTrap FF 5 mL columns due to the difference in column length vs column diameter. The amount of protein bound differed between GST-DemA and GST-Pur $\alpha$ , due to protein-dependent binding characteristics. Some of the applied protein was found in the flowthrough as an effect of the slow binding kinetics of GST. The amount of eluted GST-tagged proteins increased proportionally with increased column volume and sample load.



**Fig 5.14.** Purification and scale-up of GST-DemA on (A) GSTrap FF 1 mL, (B) GSTrap FF 5 mL, and (C) GSTPrep FF 16/10. (D) SDS-PAGE analysis of GST-DemA on ExcelGel Homogeneous 12.5% using Multiphor™ II followed by Coomassie staining. Due to the relatively slow binding kinetics of GST and rather high load, some of the applied protein was found in the flowthrough.



**Fig 5.15.** Purification and scale-up of GST-Purα on (A) GSTrap FF 1 mL, (B) GSTrap FF 5 mL, and (C) GSTPrep FF 16/10. (D) SDS-PAGE analysis of GST-Purα on ExcelGel Homogeneous 12.5% using Multiphor II followed by Coomassie staining. Due to the slow binding kinetics of GST, some of the applied protein was found in the flowthrough.




## Troubleshooting of purification methods

The troubleshooting guide below addresses problems common to the majority of purification methods as well as problems specific to a particular method. In the latter case, the relevant method is indicated.

Problem	Possible cause	Solution
GST-tagged protein does not bind or binds very poorly	The flow rate used during sample loading is too high	Decrease the flow rate during sample loading. One of the most important parameters affecting the binding of GST-tagged proteins to Glutathione Sepharose is the flow rate. Due to the relatively slow binding kinetics between GST and glutathione, it is important to keep the flow rate low during sample loading for maximum binding capacity.
	GST-tagged protein denatured by mechanical lysis (e.g., sonication). Too extensive lysis can denature the tagged protein and prevent it from binding.	Use mild mechanical/chemical lysis conditions during cell lysis. Conditions for lysis must be empirically determined.
	GST-tagged proteins have aggregated in the sample, causing precipitation	Add DTT to the sample prior to cell lysis and also add DTT to the buffers. Adding DTT to a final concentration of 1 to 20 mM may significantly increase the yield of some GST-tagged proteins.
	Concentration of tagged protein is too low	Concentrate the sample. The binding kinetics are concentration dependent. Proteins with low expression may not bind as efficiently as highly expressed proteins; therefore, concentrating the sample may improve binding.
	The tagged protein may have altered the conformation of GST, thereby reducing the affinity for the GST-tagged protein	Test the binding of GST from parental pGEX: Prepare a sonicate of cells harboring the parental pGEX plasmid and check binding to the medium. If GST produced from the parental plasmid binds with high affinity, the tagged protein may have altered the conformation of GST, thereby reducing the affinity for the GST-tagged protein. Adequate results may be obtained by reducing the temperature used for binding to 4°C, and by limiting washing.
	Equilibration time is too short	Ensure that the column has been equilibrated with at least 5 column volumes of a buffer pH 6.5 to 8.0 (e.g., PBS).
	Binding of GST-tagged proteins is not efficient at pH less than 6.5 or greater than 8	Equilibrate with a buffer pH 6.5 to 8.0 (e.g., PBS) before the clarified cell lysate is applied. Make sure that lysis is done at pH 6.5 to 8.0. Check that the sample has been adjusted to binding buffer conditions.
	GSTrap column: Column needs cleaning	Clean the column according to the standard cleaning protocol (see Appendix 2). If the GSTrap column has already been used several times, it may be necessary to use a new one.
	Glutathione Sepharose medium has been used too many times	Use fresh Glutathione Sepharose medium. Also see cleaning procedures in Appendix 2.
	GSTrap columns. The column or system is clogged, leading to high back pressure and no binding.	Clogged column: Clean the column according to instructions. Make sure the sample has been centrifuged and/or filtered through a 0.45 µm filter. Clogged system: clean system according to manual.

*continues on following page*



Problem	Possible cause	Solution
GST-tagged protein is not eluted efficiently	The volume of elution buffer is insufficient.	Increase the volume of elution buffer used. In some cases, especially after on-column cleavage of a tagged protein, a larger volume of buffer may be necessary to elute the tagged protein.
	The time allowed for elution is insufficient.	Increase the time used for elution by decreasing the flow rate during elution. With GSTrap columns, for best results use a flow rate of 0.2 to 1 mL/min (1 mL HiTrap column) and 0.5 to 5 mL/min (5 mL HiTrap column) during sample application. For centrifugation methods, decrease the centrifugation speed during elution.
	The concentration of glutathione is insufficient.	Increase the concentration of glutathione in the elution buffer: The 10 mM recommended in this protocol should be sufficient for most applications, but exceptions exist. Try 50 mM Tris-HCl, 20 to 40 mM reduced glutathione, pH 8.0 as elution buffer.
	The pH of the elution buffer is too low.	Increase the pH of the elution buffer: Increasing the pH of the elution buffer to pH 8 to 9 may improve elution without requiring an increase in the concentration of glutathione used for elution.
	The ionic strength of the elution buffer is too low.	Increase the ionic strength of the elution buffer: Adding 0.1 to 0.2 M NaCl to the elution buffer may also improve results.
	The glutathione in the elution buffer is oxidized.	Use fresh elution buffer. Add DTT.
	Nonspecific hydrophobic interactions cause nonspecific interaction with the medium or aggregation of proteins, preventing solubilization and elution of tagged proteins.	Add a nonionic detergent to the elution buffer: Adding 0.1% Tween-20 or 2% n-octylglucoside can significantly improve elution of some GST-tagged proteins.
Multiple bands are observed after electrophoresis/Western blotting analysis of eluted target protein	$M_r$ 70 000 protein copurifies with the GST-tagged protein.	The $M_r$ 70 000 protein is probably a protein product of the <i>E. coli</i> gene DnaK. This protein is involved in protein folding in <i>E. coli</i> . It has been reported that this association can be disrupted by incubating the tagged protein in 50 mM Tris-HCl, 2 mM ATP, 10 mM $MgSO_4$ , pH 7.4 for 10 min at 37°C prior to loading.  Alternatively, remove the DnaK protein by passing the tagged protein solution through ATP-agarose or a similar purification medium, or perform ion exchange.
	Partial degradation of tagged proteins by proteases.	Add a protease inhibitor: Multiple bands may be a result of partial degradation of tagged proteins by proteases. Adding 1 mM PMSF to the lysis solution may improve results. A nontoxic, water-soluble alternative to PMSF is 4-(2-aminoethyl)-benzenesulfonyl fluoride hydrochloride (AEBSF), commercially available as Pefabloc SC from Roche Biochemicals.  <i>Note:</i> Serine protease inhibitors must be removed prior to cleavage by thrombin or Factor Xa. PreScission Protease is not a consensus serine protease and is insensitive to many of the protease inhibitors tested at Cytiva.   PMSF is toxic, with acute effects. Use Pefabloc whenever possible.
	Proteolysis in the host bacteria.	Use a protease-deficient host: Multiple bands may be the result of proteolysis in the host bacteria. If this is the case, the use of a host-deficient strain may be required (e.g., lon- or ompT). <i>E. coli</i> BL21 is defective in OmpT and Lon protease production.
	Cell disruption during mechanical lysis.	Decrease lysis time: Cell disruption is apparent by partial clearing of the suspension and can be checked by microscopic examination. Adding lysozyme (0.1 volume of a 10 mg/mL lysozyme solution in 25 mM Tris-HCl, pH 8.0) prior to mechanical lysis may improve results.  Avoid frothing as this may denature the tagged protein. Over-lysis can also lead to the copurification of host proteins with the GST-tagged protein.

Problem	Possible cause	Solution
	<p>Chaperones may have copurified.</p> <p>Antibodies that react with various <i>E. coli</i> proteins may be present in the tagged protein sample.</p>	<p>Include an additional purification step: Additional bands may be caused by the copurification of a variety of proteins known as chaperones, which are involved in the correct folding of nascent proteins in <i>E. coli</i>. These include, but may not be limited to: DnaK (<math>M_r \sim 70\,000</math>), DnaJ (<math>M_r \sim 37\,000</math>), GrpE (<math>M_r \sim 40\,000</math>), GroEL (<math>M_r \sim 57\,000</math>), and GroES (<math>M_r \sim 10\,000</math>). Several methods for purifying GST-tagged proteins from these copurifying proteins have been described.</p> <p>Cross-adsorb antibody with <i>E. coli</i> proteins: Depending on the source of the anti-GST antibody, it may contain antibodies that react with various <i>E. coli</i> proteins that may be present in the tagged protein sample. Cross-adsorb the antibody with an <i>E. coli</i> sonicate to remove anti-<i>E. coli</i> antibodies from the preparation. Anti-GST antibody from Cytiva has been cross-adsorbed against <i>E. coli</i> proteins and tested for its lack of nonspecific background binding in Western blots.</p>
<p>Multiple bands are observed after electrophoretic analysis of cleaved target protein</p>	<p>Proteolysis has occurred in the host bacteria.</p>	<p>Determine when the bands appear: Test to be certain that additional bands are not present prior to PreScission Protease, thrombin, or Factor Xa cleavage. Such bands may be the result of proteolysis in the host. Tagged partner may contain recognition sequences for PreScission Protease, thrombin, or Factor Xa: Check the sequences.</p> <p>See the <i>GST Gene Fusion System Handbook</i>, 18115758, for details.</p>

## Detection of GST-tagged proteins

Several methods are available for detection of GST-tagged proteins, with method selection largely depending on the experimental situation. For example, SDS-PAGE analysis, although frequently used for monitoring results during expression and purification, may not be the method of choice for routine monitoring of samples from high-throughput screening. Functional assays based on the properties of the protein of interest (and not the GST tag) are useful but must be developed for each target protein. These assays are not covered in this handbook.

Much of the information presented below can also be applied to detection of histidine-tagged proteins, although the specific reagents will change.

### GST Detection Module with CDNB enzymatic assay


GST-tagged proteins produced using pGEX vectors can be detected enzymatically using the GST substrate 1-chloro-2,4 dinitrobenzene (CDNB), included in the GST Detection Module. The GST-mediated reaction of CDNB with glutathione produces a conjugate that is measured by absorbance at 340 nm using either a plate reader or a UV/Vis spectrophotometer. Assay results are available in less than 10 min for crude bacterial sonicates, column eluates, or purified GST-tagged protein. Figure 5.16 shows typical results from a CDNB assay. Each GST Detection Module contains reagents sufficient for 50 assays.

### Components of GST Detection Module used with the CDNB enzymatic assay

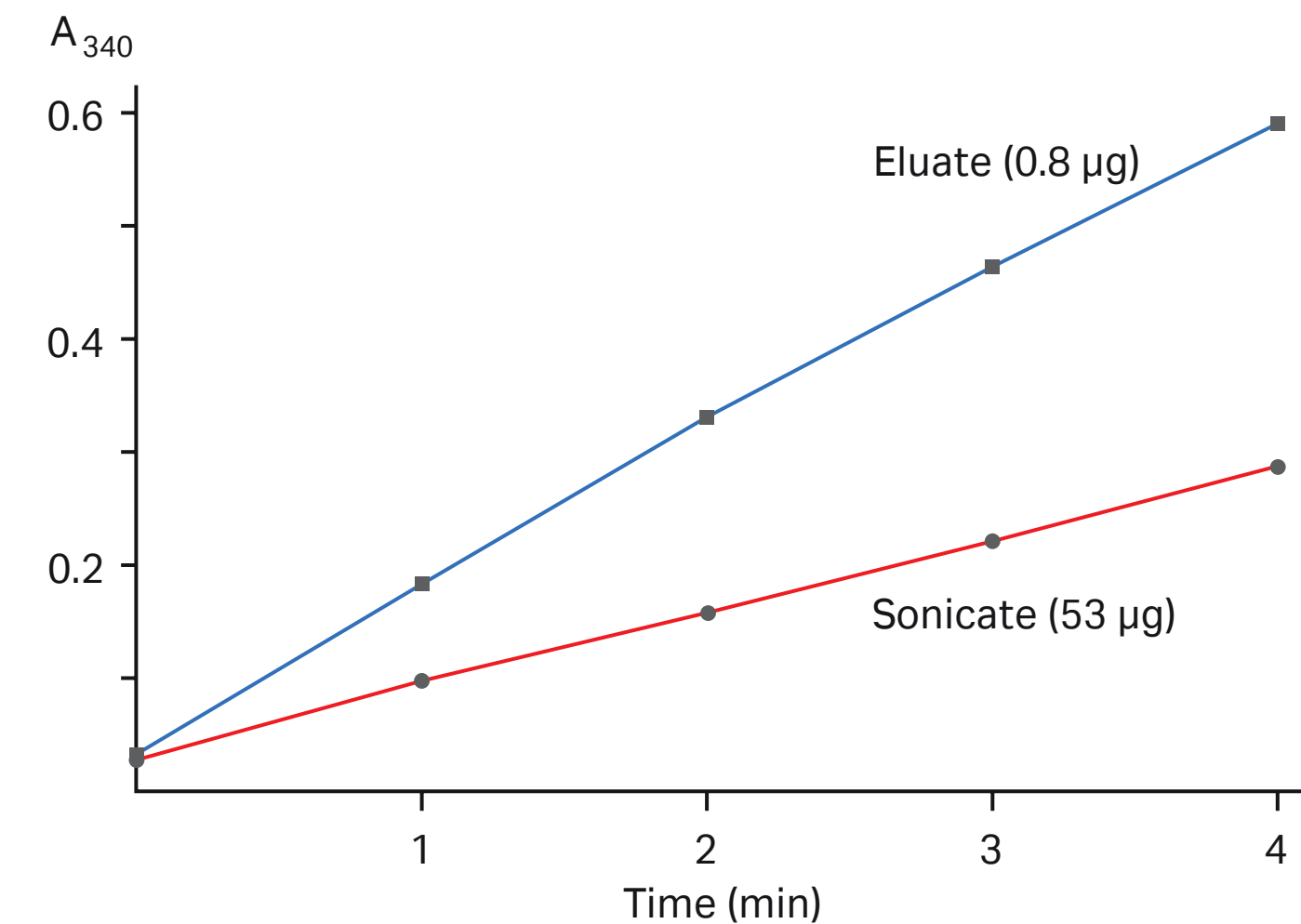
10× reaction buffer: 1 M  $\text{KH}_2\text{PO}_4$  buffer, pH 6.5

CDNB: 100 mM 1-chloro-2,4-dinitrobenzene (CDNB) in ethanol

Reduced glutathione powder: Prepare a 100 mM solution by dissolving the glutathione in sterile distilled water. Aliquot into microcentrifuge tubes. Store at  $-20^\circ\text{C}$ . Avoid more than five freeze/thaw cycles.

 CDNB is toxic. Avoid contact with eyes, skin, and clothing. In case of accidental contact, flush affected area with water. In case of ingestion, seek immediate medical attention.

 pGEX-bearing cells must be lysed prior to performing a CDNB assay.



**Fig 5.16.** Typical results of a CDNB assay for GST-tagged proteins. 53 µg of total protein from an *E. coli* TG1/pGEX-4T-Luc sonicate and 0.8 µg of total protein eluted from Glutathione Sepharose were assayed according to instructions included with the GST Detection Module.



## Steps


1. In a microcentrifuge tube, combine the following:

Distilled water	880 $\mu$ L
10 $\times$ reaction buffer	100 $\mu$ L
CDNB	10 $\mu$ L
Glutathione solution	10 $\mu$ L
Total volume	1000 $\mu$ L

2. Cap the tube and mix the contents by inverting several times.

 CDNB may cause the solution to become slightly cloudy. However, the solution should clear upon mixing.

3. Transfer 500  $\mu$ L volumes of the above CDNB solution into two UV-transparent cuvettes labeled sample and blank. Add sample (5 to 50  $\mu$ L) to the sample cuvette. To the blank cuvette, add 1 $\times$  reaction buffer equal in volume to that of the sample in the sample cuvette.
4. Cover each cuvette with wax film and invert to mix.
5. Place the blank cuvette into the spectrophotometer and blank at 340 nm. Measure the absorbance of the sample cuvette at 340 nm and simultaneously start a stopwatch or other timer.
6. Record absorbance readings at 340 nm at 1 min intervals for 5 min by first blanking the spectrophotometer with the blank cuvette and then measuring the absorbance of the sample cuvette.

 For analyses using 96-well plates, add samples to the cells first and add reagents second. Mix the contents of the wells using the pipette. Start measuring the absorbance in the plate reader.


7. Calculate the  $A_{340}$ /min/mL sample as follows:

### Calculations

$$\Delta A_{340}/\text{min/mL} = \frac{A_{340}(t_2) - A_{340}(t_1)}{(t_2 - t_1)(\text{mL sample added})}$$

Where:  $A_{340}(t_2)$  = absorbance at 340 nm at time  $t_2$  in min

$A_{340}(t_1)$  = absorbance at 340 nm at time  $t_1$  in min

  $\Delta A_{340}$ /min/mL values can be used as a relative comparison of GST-tagged protein content between samples of a given tagged protein.

## Western blot

Expression and purification of GST-tagged proteins can be monitored by Western blot analysis, Amersham ECL is a chemiluminescent detection reagent providing adequate sensitivity for most recombinant expression applications. For higher sensitivity, use Amersham ECL Prime or Amersham ECL Select (chemiluminescence), alternatively, Amersham ECL Plex (fluorescence). The combination of Western blot detection and total protein staining of the SDS-PAGE (using Coomassie, or silver stain) gives a powerful control of purification results. See *Western Blotting: Principles and Methods*, 28999897.

## Troubleshooting of detection methods

The troubleshooting guide below addresses problems common to the majority of detection methods as well as problems specific to a particular method. In the latter case, the relevant method is indicated.

Problem	Possible cause	Solution
Poor results with the GST Detection Module	<p>The reaction rate is nonlinear.</p> <p>The target protein has inhibited the folding of the GST tag.</p> <p>There is baseline drift.</p>	<p>The reaction rate of the CDNB assay is linear provided that an <math>A_{340}</math> of <math>\sim 0.8</math> is not exceeded during the 5-min time course.</p> <p>Plot initial results to verify that the reaction rate is linear over the time course. Adjust the amount of sample containing the GST-tagged protein to maintain a linear reaction rate.</p> <p>The tagged protein may have inhibited the correct folding of the GST moiety. The GST-tagged proteins will thus show very low activity with the CDNB assay. Whether for this or for any other reason, if a low absorbance is obtained using the CDNB assay, a Western blot using anti-GST antibody may reveal high levels of tagged protein expression.</p> <p>Under standard assay conditions at 22°C and in the absence of GST, glutathione and CDNB react spontaneously to form a chemical moiety that produces a baseline drift at <math>\Delta A_{340} / \text{min}</math> of <math>\sim 0.003</math> (or 0.015 in 5 min). Correct for baseline drift by blanking the spectrophotometer with the blank cuvette before each reading of the sample cuvette. Alternatively, get the slope directly from the spectrophotometer software. The slope will be the same as long as the spontaneous reaction is limited.</p>
No signal in Western blotting	<p>Proteins are not transferred during Western blotting.</p> <p>Proteins are not retained on membrane.</p> <p>There are problems with detection reagents.</p>	<p>Stain gel and membrane with total protein stain to check transfer efficiency. Optimize gel acrylamide concentration, time for transfer, and current.</p> <p>Ensure gel and membrane make proper contact during blotting and are oriented correctly with respect to the anode.</p> <p>Check that excess temperatures are not reached during electroblotting, producing bubbles or membrane distortion.</p> <p>Assess transfer of proteins (as above). Use a fresh supply of membrane.</p> <p>Ensure reagents are being used correctly. Prepare reagents freshly each time. Store reagents at correct temperature.</p>
Weak signal in Western blotting	<p>Protein transfer efficiency is poor.</p> <p>Insufficient protein has been loaded.</p> <p>Exposure time is too short.</p>	<p>Check transfer efficiency as above.</p> <p>Load more protein on gel.</p> <p>Increase exposure time.</p>
Excessive diffuse signal in Western blotting	<p>Too much protein has been loaded.</p>	<p>Reduce the amount of protein loaded.</p>


*continues on following page*


<b>Problem</b>	<b>Possible cause</b>	<b>Solution</b>
High backgrounds in Western blotting	Washing is inadequate.	Ensure post-conjugate washes are performed for a sufficient amount of time with an adequate volume of wash buffer (> 4 mL/cm <sup>2</sup> membrane).
	Blocking is inadequate.	Check the blocking buffer has been made correctly. Use freshly prepared blocking buffer each time. Increase the concentration of blocking reagent — try 10%. Use alternative blocking agent (e.g., 1% to 10% BSA, 0.5% to 3% gelatin). Increase incubation time with blocking buffer.
	Blotting equipment or buffers are contaminated.	Clean equipment. Prepare fresh buffers.
Multiple bands are seen in Western blotting	Conjugate is binding non-specifically to other proteins.	Include a negative control of expression host not containing expression vector to determine nonspecific binding.
	GST-tagged protein may have been degraded.	Include protease inhibitors during purification. Reduce purification time and temperature. Add a second purification step to remove incomplete target protein.





## Removal of GST tag by enzymatic cleavage

Removal of the GST tag is often necessary to be able to perform functional or structural studies of the target protein. Tagged proteins containing a PreScission Protease, thrombin, or Factor Xa recognition site can be cleaved either while bound to Glutathione Sepharose or in solution after elution. Cleavage releases the target protein from the column and allows elution using the binding buffer. The GST moiety remains bound to the medium.

 PreScission Protease itself has a GST tag and therefore will bind to Glutathione Sepharose; it will thus not co-elute and contaminate the cleaved target protein. Cleavage with PreScission Protease is very specific, and maximum cleavage is obtained in the cold (the protein is most active at 4°C), thus improving the stability of the target protein.

 If thrombin or Factor Xa are used for cleavage of the tag, a convenient way to remove these enzymes is to connect in series one GSTrap FF column and one HiTrap Benzamidine FF (high sub) column. During the elution the cleaved product passes directly from the GSTrap into the HiTrap Benzamidine FF (high sub). The cleaved target protein passes through the HiTrap Benzamidine FF (high sub) column but the proteases bind. Thus in a single step the enzymes are removed and a pure cleaved target protein is achieved (see Fig 5.17). Note, however, that thrombin and Factor Xa may produce a less specific cleavage than PreScission Protease and that sometimes the target protein can be fragmented itself.

 The amount of enzyme, temperature, and length of incubation required for complete digestion varies according to the specific GST-tagged protein produced. Optimal conditions should always be determined in pilot experiments.

 If protease inhibitors (see Table 5.6) have been used in the lysis solution, they must be removed prior to cleavage with PreScission Protease, thrombin, or Factor Xa. (The inhibitors will usually be eluted in the flowthrough when sample is loaded onto a GSTrap column.)

Cleavage of tagged proteins is most commonly performed on milligram quantities of tagged protein suitable for purification on GSTrap columns. Protocols that follow describe manual cleavage and purification using a syringe and a 1 mL or 5 mL GSTrap column. The protocols can be adapted for use with GST MultiTrap or GST SpinTrap columns to work at smaller scales.

For quick scale-up of purifications, two or three GSTrap columns can be connected in series (back pressure will be higher). Further scaling-up is possible using GSTPrep FF 16/10 columns or columns packed by the user. Protocols below are included for column or batch format using Glutathione Sepharose 4 Fast Flow, but this medium can easily be replaced with Glutathione Sepharose High Performance or Glutathione Sepharose 4B depending on what is the preferred chromatography medium in the lab.

**Table 5.5.** Approximate molecular weights for SDS-PAGE analysis

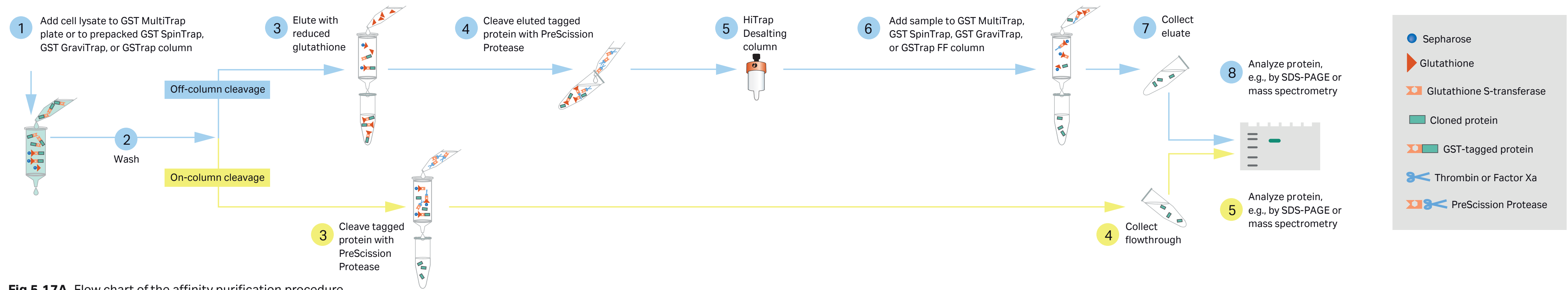
Protease	Molecular weight
PreScission Protease <sup>1</sup>	46 000
Bovine thrombin	37 000
Bovine Factor Xa	48 000

<sup>1</sup> PreScission Protease is a tagged protein of glutathione S-transferase and human rhinovirus type 14 3C protease.

**Table 5.6.** Inhibitors of the various proteases

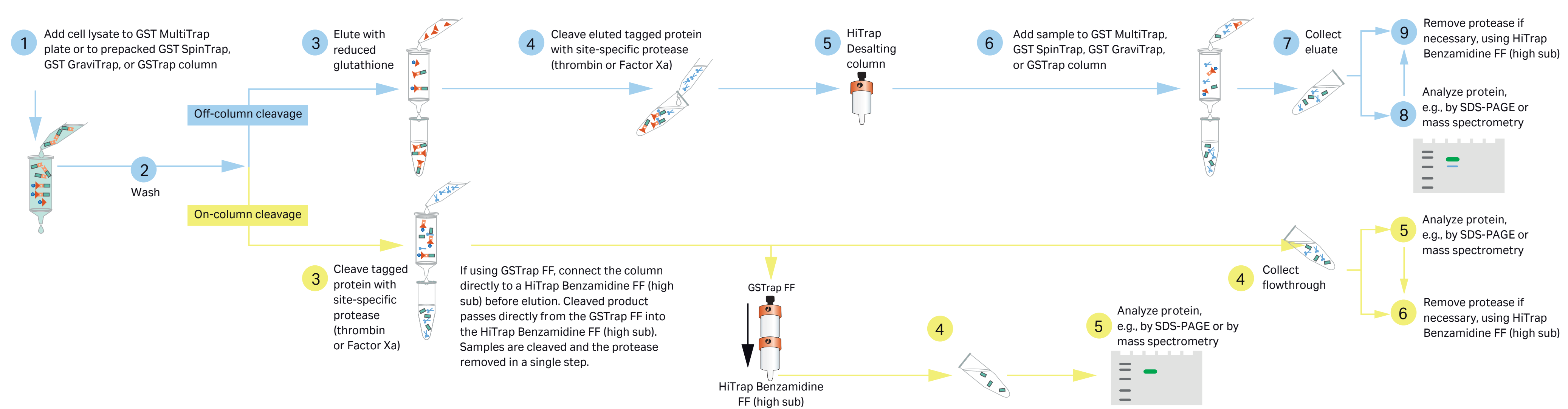
Enzyme	Inhibitor
PreScission Protease	100 mM ZnCl <sub>2</sub> (> 50% inhibition) 100 μM chymostatin 4 mM Pefabloc
Factor Xa and thrombin	AEBSF, APMSF, antithrombin III, Antipain, α1-antitrypsin, aprotinin, chymostatin, hirudin, leupeptin, PMSF
Factor Xa only	Pefabloc FXa
Thrombin only	Pefabloc TH Benzamidine

### Cleavage of GST tag using PreScission Protease



**Fig 5.17A.** Flow chart of the affinity purification procedure and PreScission Protease cleavage of GST-tagged proteins.

### Cleavage of GST tag using thrombin or Factor Xa



**Fig 5.17B.** Flow chart of the affinity purification procedure and thrombin or Factor Xa cleavage of GST-tagged proteins.

## Cleavage and purification of GST-tagged protein bound to GSTrap FF

### Recommended buffers

Binding buffer: PBS: 140 mM NaCl, 2.7 mM KCl, 10 mM Na<sub>2</sub>HPO<sub>4</sub>, 1.8 mM KH<sub>2</sub>PO<sub>4</sub>, pH 7.3

#### For PreScission Protease cleavage:

Elution buffer: 50 mM Tris-HCl, 10 mM reduced glutathione, pH 8.0

Cleavage buffer: 50 mM Tris-HCl, 150 mM NaCl, 1 mM EDTA, 1 mM DTT, pH 7.0

PreScission Protease

#### For thrombin cleavage:

Elution buffer: 50 mM Tris-HCl, 10 mM reduced glutathione, pH 8.0

Cleavage buffer: PBS: 140 mM NaCl, 2.7 mM KCl, 10 mM Na<sub>2</sub>HPO<sub>4</sub>, 1.8 mM KH<sub>2</sub>PO<sub>4</sub>, pH 7.3

Thrombin solution: Dissolve 500 units in 0.5 mL of PBS prechilled to 4°C. Swirl gently. Store solution in small aliquots at -80°C to preserve activity.

#### For Factor Xa cleavage:

Elution buffer: 50 mM Tris-HCl, 10 mM reduced glutathione, pH 8.0

Cleavage buffer: 50 mM Tris-HCl, 150 mM NaCl, 1 mM CaCl<sub>2</sub>, pH 7.5

Factor Xa solution: Dissolve 400 units of Factor Xa in 4°C water to give a final solution of 1 unit/μL. Swirl gently. Store solution in small aliquots at -80°C to preserve activity.


### Purification and cleavage

The protocol below is an example optimized for 8 mg of target protein. It is worth estimating how much target protein is applied to the column, as this allows one to minimize the amount of protease added.

1. Fill the syringe or pump tubing with distilled water. Remove the stopper and connect the column to the syringe (use the connector supplied), laboratory pump, or chromatography system "drop to drop" to avoid introducing air into the system.
2. Remove the snap-off end at the column outlet.
3. Wash out the ethanol with 3 to 5 column volumes of distilled water.
4. Equilibrate the column with at least 5 column volumes of binding buffer. Recommended flow rates are 1 mL/min (1 mL column) and 5 mL/min (5 mL column).
5. Apply the pretreated sample using a syringe fitted to the Luer connector or by pumping it onto the column. For best results, use a flow rate of 0.2 to 1 mL/min (1 mL column) and 0.5 to 5 mL/min (5 mL column) during sample application.
6. Wash with binding buffer (generally at least 5 to 10 column volumes) until the absorbance reaches a steady baseline or no material remains in the effluent. Maintain a flow rate of 1 to 2 mL/min (1 mL column) and 5 to 10 mL/min (5 mL column) for washing.
- 7a. For PreScission Protease and Factor Xa, wash the column with 10 column volumes of cleavage buffer.
- 7b. For thrombin, proceed to step 8b.
- 7c. For Factor Xa, proceed to step 8c.



- 8a. Prepare the PreScission Protease mix:
  - For GSTrap FF 1 mL columns, mix 80  $\mu$ L (160 units) of PreScission Protease with 920  $\mu$ L of PreScission cleavage buffer at 5°C.
  - For GSTrap FF 5 mL columns, mix 400  $\mu$ L (800 units) of PreScission Protease with 4.6 mL of PreScission cleavage buffer at 5°C.
- 8b. Prepare the thrombin mix:
  - For GSTrap FF 1 mL columns, mix 80  $\mu$ L (80 units) of thrombin solution with 920  $\mu$ L of PBS.
  - For GSTrap FF 5 mL columns, mix 400  $\mu$ L (400 units) of thrombin solution with 4.6 mL of PBS.
- 8c. Prepare the Factor Xa mix:
  - For GSTrap FF 1 mL columns, mix 80  $\mu$ L (80 units) of Factor Xa solution with 920  $\mu$ L of Factor Xa cleavage buffer.
  - For GSTrap FF 5 mL columns, mix 400  $\mu$ L (400 units) of Factor Xa solution with 4.6 mL of Factor Xa cleavage buffer.
9. Load the protease mix onto the column using a syringe and the connector supplied. Seal the column with the top cap and the stopper supplied.
- 10a. For PreScission Protease, incubate the column at 5°C for 4 h.
- 10b. For thrombin and Factor Xa, incubate the column at room temperature (22°C to 25°C) for 2 to 16 h.

 The incubation times are starting points and may need to be changed for an optimal yield of cleaved target protein.

11. Fill a syringe with 3 mL (1 mL column) or 15 mL (5 mL column) of cleavage buffer. Remove the top cap and stopper from the column and attach the syringe. Avoid introducing air into the column.
12. Begin elution of the cleaved target protein. Maintain flow rates of 1 to 2 mL/min (1 mL column) or (5 mL column), and collect the eluate (0.5 to 1 mL/tube for 1 mL column, 1 to 2 mL/tube for 5 mL column).

**For PreScission Protease:** The eluate will contain the protein of interest, while the GST moiety of the tagged protein and the PreScission Protease (also GST-tagged) will remain bound to the GSTrap column. This means that the protein of interest will not be contaminated with protease and thus no additional purification will be required to purify the target protein from the protease.

**For thrombin and Factor Xa:** The eluate will contain the protein of interest and thrombin or Factor Xa, respectively, while the GST moiety of the tagged protein will remain bound to the GSTrap column. Thrombin or Factor Xa can be removed from the protein of interest in one step using a HiTrap Benzamidine FF (high sub) column in series after the GSTrap column. In this process, the cleaved, tagged protein and thrombin or Factor Xa is washed from the GSTrap column onto the HiTrap Benzamidine FF (high sub) column. This second column captures the thrombin or Factor Xa, thus enabling the collection of free protein in the eluent. Refer to Figure 5.20 for an example of the purification and on-column cleavage of GST-tagged SH2 domain using thrombin and GSTrap FF, with sample cleanup accomplished using HiTrap Benzamidine FF (high sub) column in series with GSTrap FF. See *Removal of thrombin and Factor Xa using HiTrap Benzamidine FF (high sub)* later on in this chapter for the procedure.

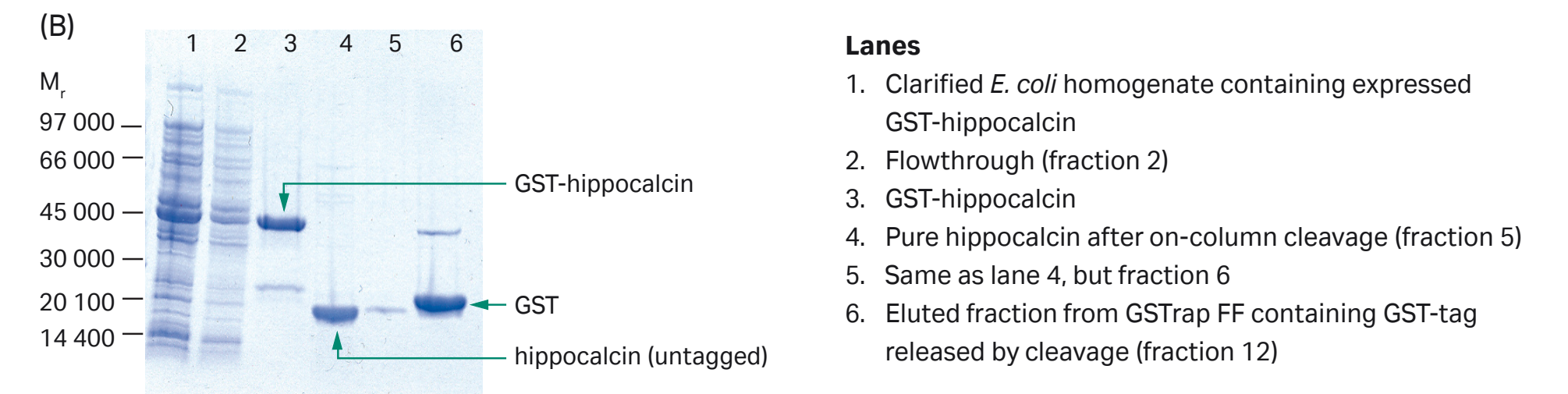
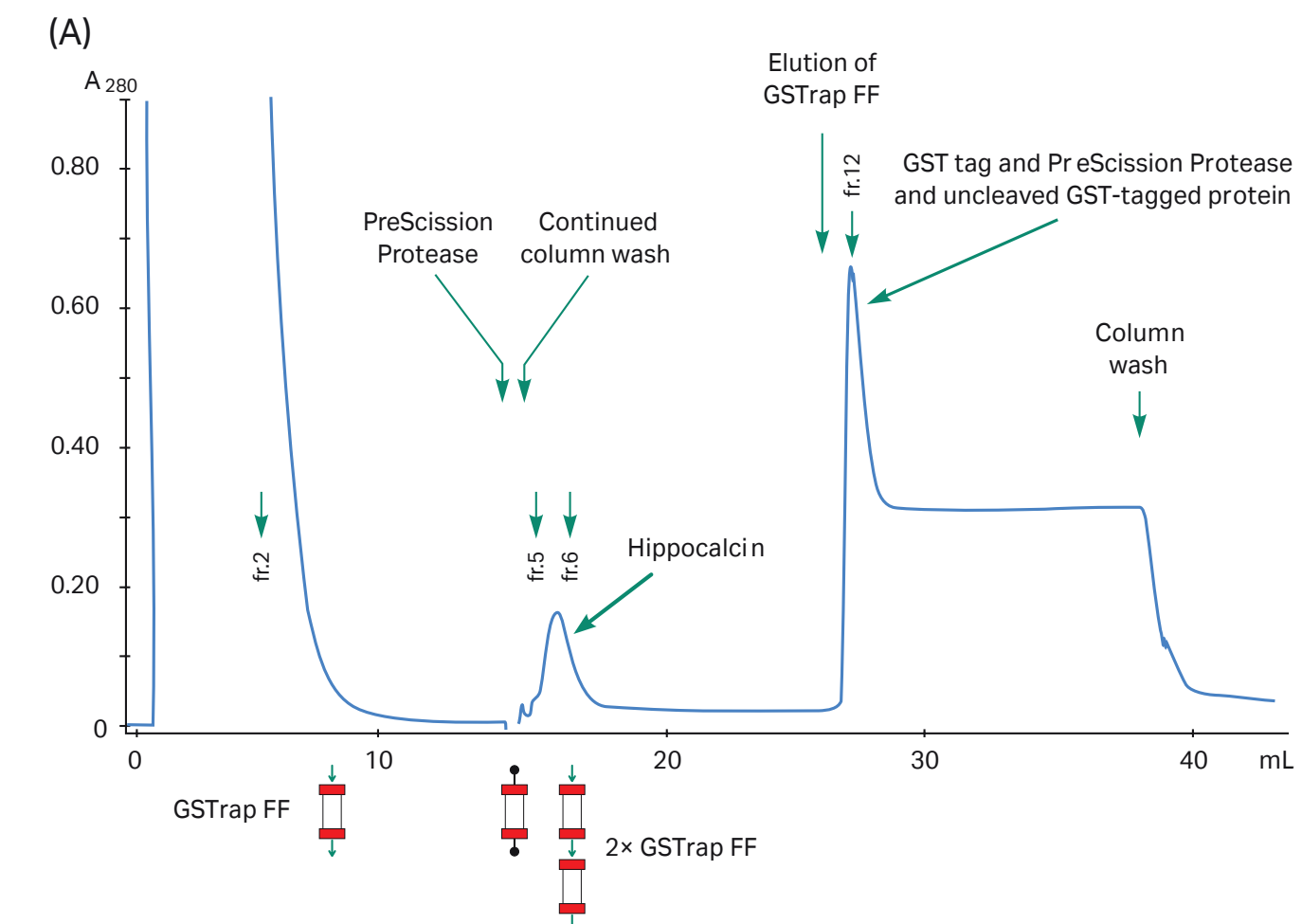
See Appendix 2 for details on regenerating the GSTrap column for subsequent purifications.

## Application examples

### 1. Purification of human hippocalcin using GSTrap FF columns in series with on-column cleavage by PreScission Protease

The gene for human hippocalcin, a member of the neuron-specific calcium-binding protein family, was cloned into a pGEX vector containing a PreScission Protease site adjacent to the GST tag. The expressed tagged protein was captured on a GSTrap FF 1 mL column. The column was then incubated overnight at 4°C and for an additional 2 h at room temperature with PreScission Protease (which is GST-tagged itself). Following on-column cleavage, a second GSTrap FF 1 mL column was placed in series after the first to remove any PreScission Protease, uncleaved GST-tagged protein, or free GST tag that could co-elute with the sample during the additional wash with binding buffer (Fig 5.18). For every gram of wet *E. coli* cells, 10 mg of pure, untagged hippocalcin was obtained.

**Sample:** 2 mL clarified *E. coli* homogenate containing expressed GST-hippocalcin,  $M_r$  43 000  
**Columns:** 2× GSTrap FF 1 mL  
**Binding and wash buffer:** 50 mM Tris-HCl, 0.15 M NaCl, 1 mM  $CaCl_2$ , 1 mM DTT, 10% glycerol, pH 8.0  
**GST elution buffer:** 20 mM reduced glutathione, 50 mM Tris-HCl, pH 8.0  
**Flow rate:** 0.5 mL/min  
**System:** ÄKTA system  
**Protease treatment:** 80 U/mL PreScission Protease overnight at 4°C and then 2 h at room temperature



**Fig 5.18.** Purification of human hippocalcin-GST-tagged protein with on-column cleavage and post-cleavage removal of PreScission Protease using GSTrap FF columns. (A) Chromatogram showing purification of hippocalcin. (B) SDS-PAGE analysis of various sample processing steps. ExcelGel SDS Gradient, 8–18, Coomassie blue staining.

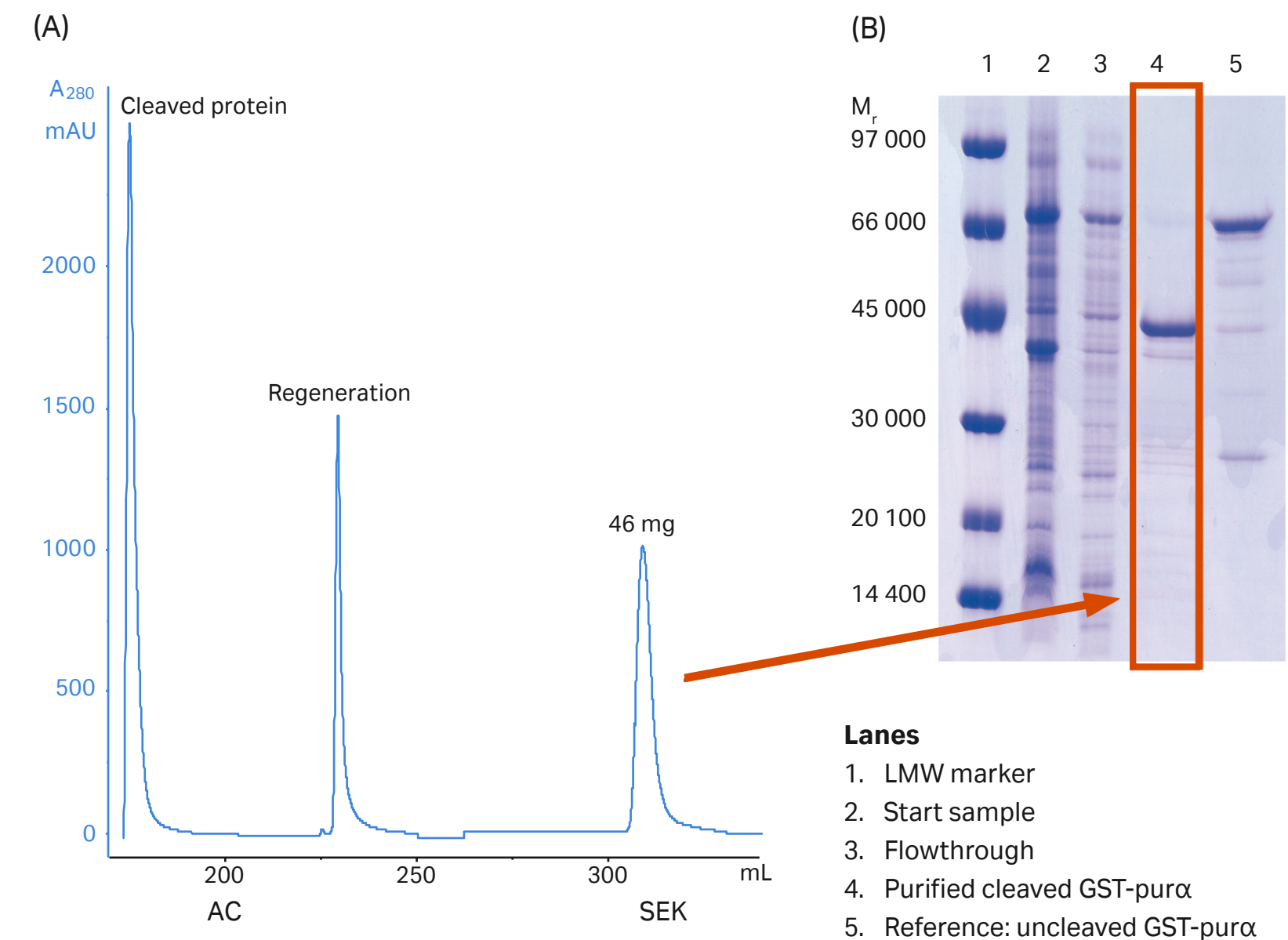
## 2. Automatic removal of the GST tag with PreScission Protease

This example of automated tag removal uses ÄKTExpress. All multistep purification protocols in ÄKTExpress can be combined with automated on-column tag cleavage. Tag cleavage is always performed on the affinity column prior to further purification steps. When the cleaved protein has been eluted, the affinity column is regenerated and affinity tag, tagged protease, and remaining uncleaved protein are collected in a separate outlet. The procedure involves binding the tagged protein, injection of protease, incubation, elution of cleaved protein, and collection in capillary loop(s), followed by further purification steps.

The example in Figure 5.19 shows purification results for a GST-tagged protein, GST-pur $\alpha$  ( $M_r$  61 600), expressed in *E. coli*. The  $M_r$  of the cleaved product is 35 200. After harvest, cell lysis was performed by sonication. The samples were clarified by centrifugation prior to sample loading.

AC and SEC were performed on ÄKTExpress using columns as indicated in the figure. The purity of each sample was analyzed by SDS-PAGE (Coomassie staining). The reduced samples were applied on an ExcelGel SDS-polyacrylamide gel.

**Sample:** GST-pur $\alpha$ ,  $M_r$  61 600 (cleaved product  $M_r$  35 200)  
**Columns:** AC: GSTrap HP 5 mL  
SEC: HiLoad 16/60 Superdex 75 pg, 120 mL  
**AC binding and cleavage buffer:** 20 units of PreScission Protease/mg protein, 8 h incubation time in cold room  
50 mM Tris-HCl, 150 mM NaCl, 1 mM EDTA, 1 mM DTT, pH 7.5  
**AC elution buffer:** 50 mM Tris-HCl, 10 mM reduced glutathione, pH 8.0  
**SEC buffer:** 50 mM Tris-HCl, 150 mM NaCl, pH 7.5



**Fig 5.19.** (A) Two-step protocol for automatic GST-tagged protein cleavage with PreScission Protease and purification. (B) Analysis by SDS-polyacrylamide gel (Coomassie staining) of the untagged target protein after purification and cleavage.

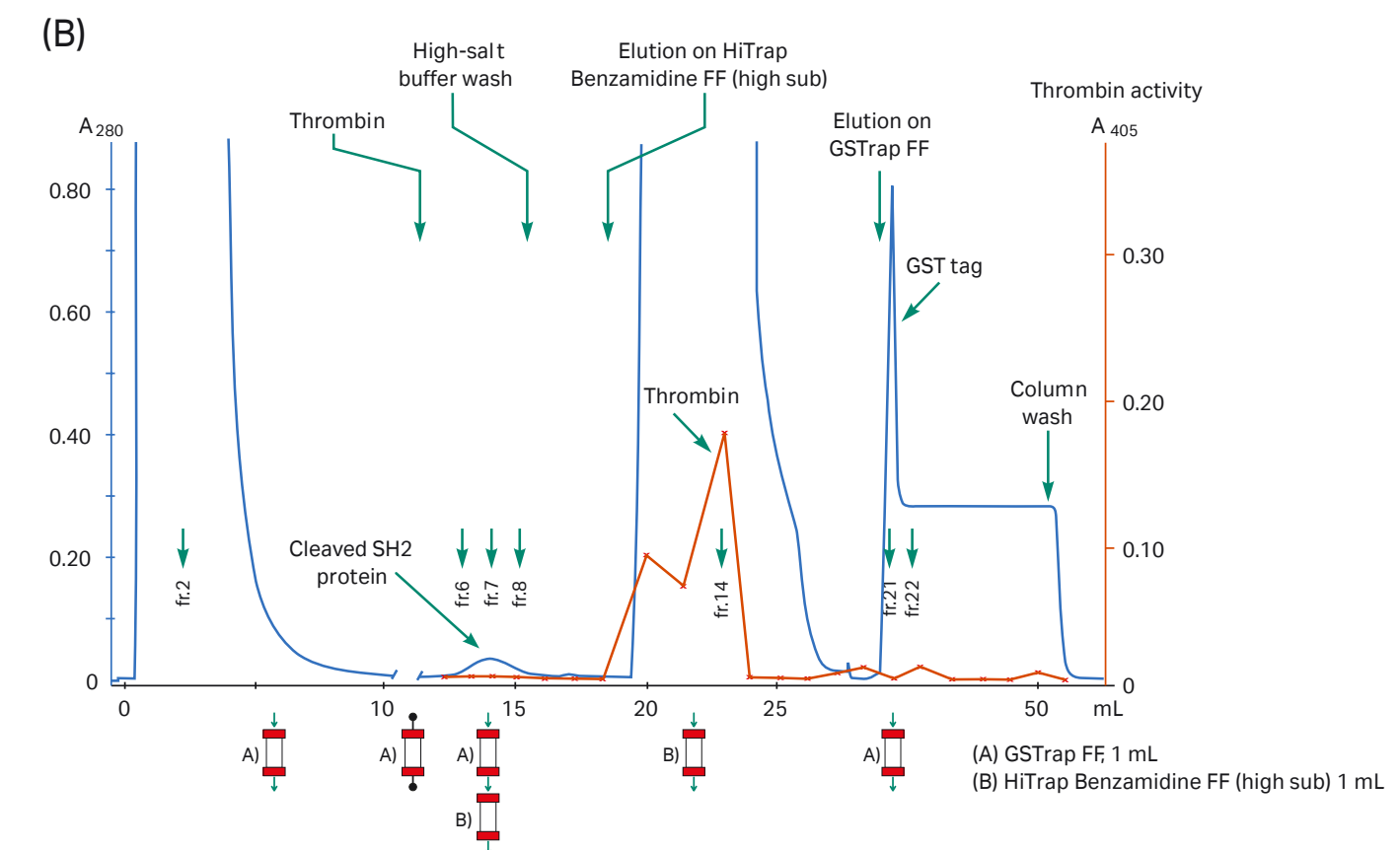
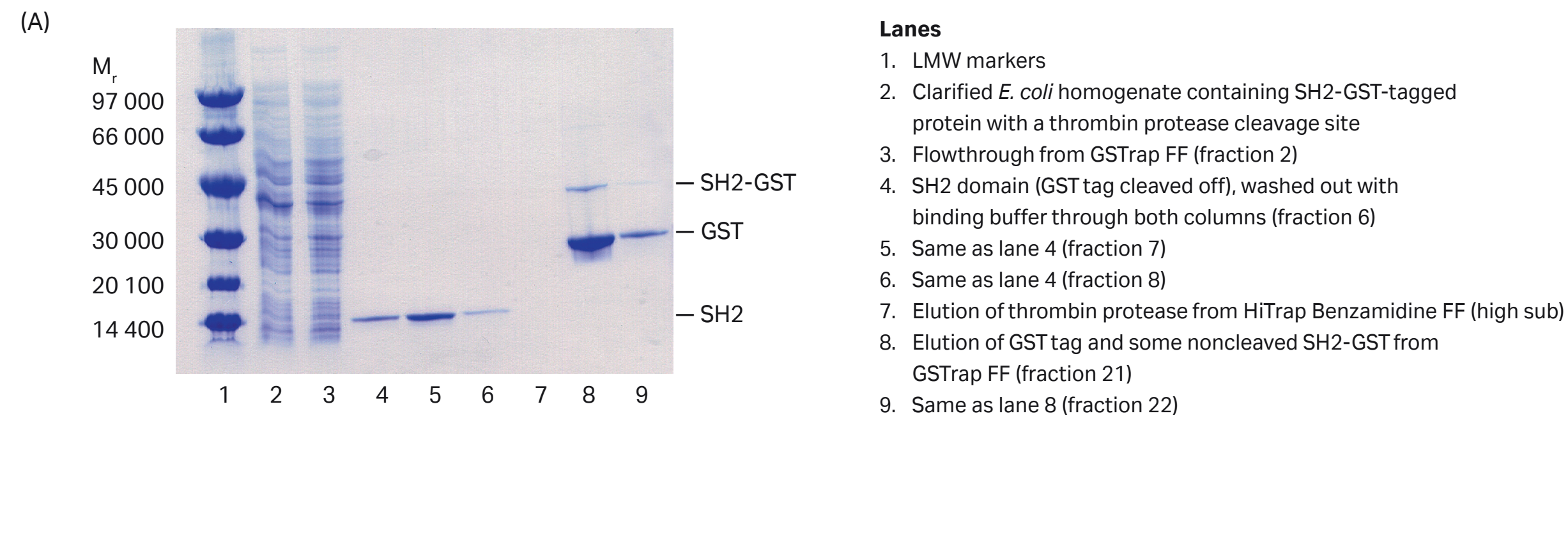


### 3. Purification and on-column cleavage of GST-tagged SH2 domain using thrombin and GSTrap FF.

#### Direct removal of thrombin using HiTrap Benzamidine FF (high sub) column in series with GSTrap FF

The following application describes the purification of GST-SH2 ( $M_r$  37 000) on a GSTrap FF 1 mL column, followed by on-column cleavage with thrombin (Fig 5.20). After the thrombin incubation step, a HiTrap Benzamidine FF (high sub) 1 mL column was placed in series after the GSTrap FF column. As the columns were washed with binding buffer and later with high-salt buffer, the cleaved SH2-tagged protein and thrombin were washed from the GSTrap FF column onto the HiTrap Benzamidine FF (high sub) column. Thrombin was captured by this second column, thus enabling the collection of pure thrombin-free untagged target protein in the eluent (Fig 5.20A). Complete removal of thrombin was verified using the chromogenic substrate S-2238 (Chromogenix, Haemochrom Diagnostica AB; supplier in US is DiaPharma) for detection of thrombin activity (Fig 5.20B). This entire procedure could be completed in less than one day.

<i>Sample:</i>	2 mL clarified <i>E. coli</i> homogenate containing GST-SH2 ( $M_r$ 37 000) with a thrombin protease cleavage site
<i>Columns:</i>	GSTrap FF 1 mL and HiTrap Benzamidine FF (high sub) 1 mL
<i>Binding buffer:</i>	20 mM sodium phosphate, 0.15 M NaCl, pH 7.5
<i>High salt wash buffer:</i>	20 mM sodium phosphate, 1.0 M NaCl, pH 7.5
<i>Benzamidine elution buffer:</i>	20 mM p-aminobenzamidine in binding buffer
<i>GST elution buffer:</i>	20 mM reduced glutathione, 50 mM Tris, pH 8.0
<i>Flow rate:</i>	0.5 mL/min
<i>System:</i>	ÅKTA system
<i>Protease treatment:</i>	20 U/mL thrombin protease (Cytiva) for 2 h at room temperature
<i>Thrombin protease activity:</i>	Measured at 405 nm using S-2238 (Chromogenix, Haemochrom Diagnostica AB; supplier in US is DiaPharma) as substrate



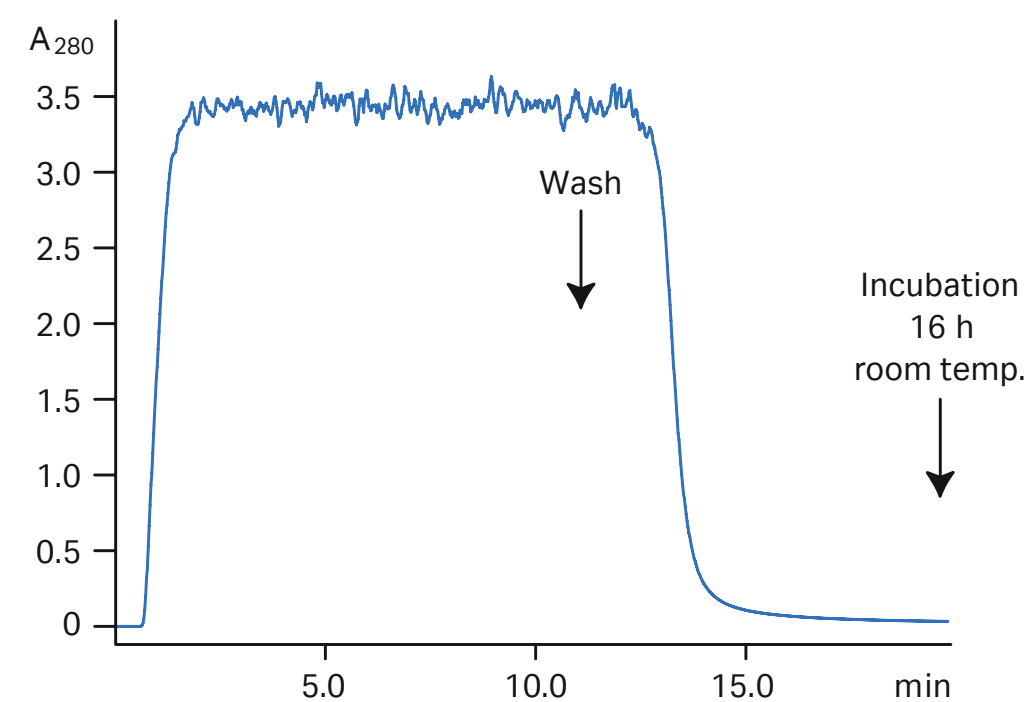
**Fig 5.20.** Purification of GST-SH2 GST-tagged protein with on-column cleavage and post-cleavage removal of thrombin using GSTrap FF and HiTrap Benzamidine FF (high sub) columns. (A) SDS-PAGE analysis of various sample processing steps. ExcelGel SDS Gradient 8–18, Coomassie blue staining. (B) Chromatogram (blue: absorbance at 280 nm) and thrombin activity curve (red) demonstrating all steps in the purification of the SH2 domain.

#### 4. On-column cleavage of a GST-tagged protein using thrombin on a GSTrap FF column

To demonstrate the efficiency of on-column cleavage in conjunction with purification, a GST-tagged protein containing the recognition sequence for thrombin, was applied to GSTrap FF 1 mL. After washing, the column was filled by syringe with 1 mL of thrombin solution (20 U/mL in PBS, pH 7.3) and sealed using the supplied connectors. After incubation for 16 h at room temperature, the target protein minus the GST moiety was eluted using PBS, pH 7.3, and the bound GST was subsequently eluted using elution buffer (Fig 5.21). The cleavage reaction yield was 100%. Intact GST-tagged protein was not detected in the eluate by SDS-PAGE and silver staining (see Fig 5.21C, lane 5).

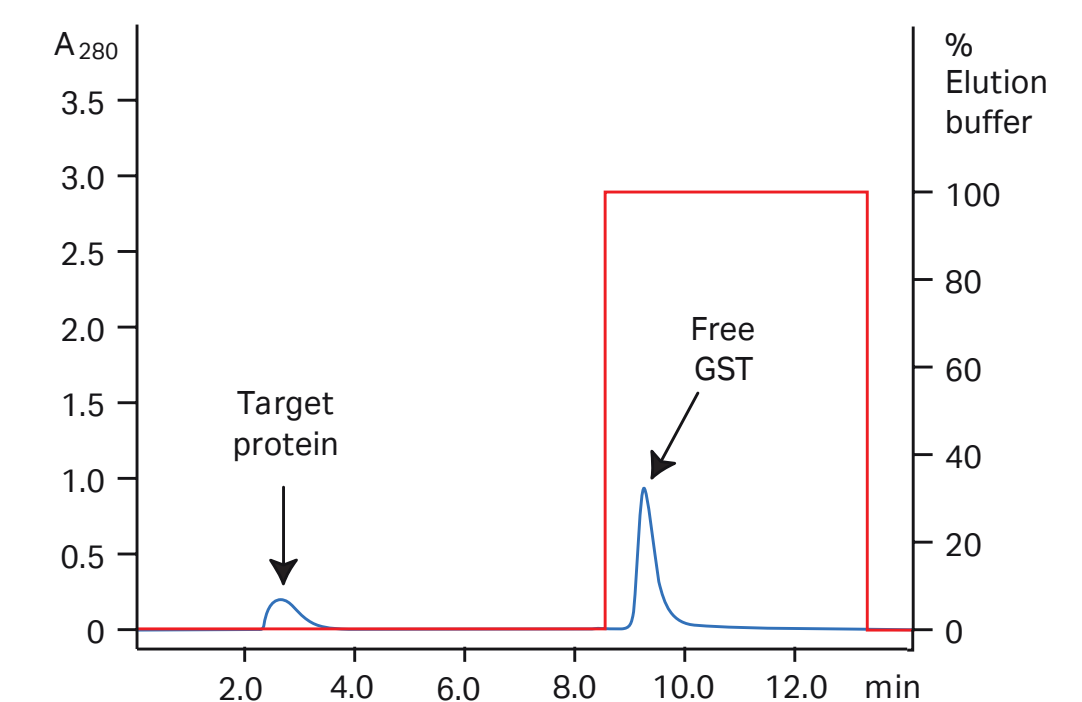
(A)

**Sample:** 10 mL clarified cytoplasmic extract from *E. coli* expressing a GST-tagged protein  
**Column:** GSTrap FF 1 mL  
**Binding buffer:** PBS, pH 7.3 (150 mM NaCl, 0 mM phosphate buffer)  
**Flow rate:** 1 mL/min  
**Chromatographic procedure:** 4 column volumes (CV) binding buffer, 10 mL sample, 10 CV binding buffer, fill column with 1 mL thrombin protease solution using a syringe  
**System:** ÄKTA



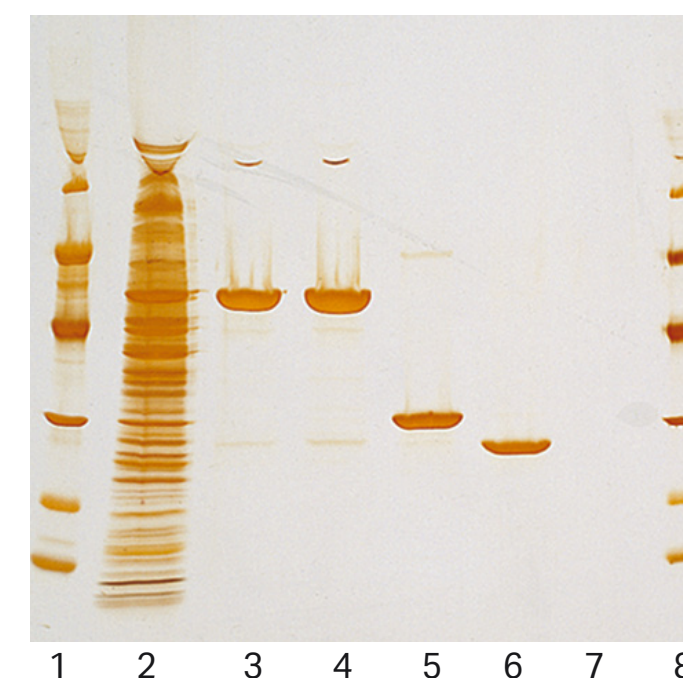
(B)

**Column:** GSTrap FF 1 mL column after 16 h incubation with thrombin protease  
**Binding buffer:** PBS, pH 7.3 (150 mM NaCl, 20 mM phosphate buffer)  
**Elution buffer:** 10 mM reduced glutathione, 50 mM Tris-HCl, pH 8.0  
**Flow rate:** 1 mL/min  
**Chromatographic procedure:** 8 column volumes (CV) binding buffer (elution of cleaved target protein), 5 CV elution buffer (elution of free GST and noncleaved GST-tagged protein), 5 CV binding buffer  
**System:** ÄKTA



(C)

$M_r$   
 97 000  
 66 000  
 45 000  
 30 000  
 20 100  
 14 400



**Lanes**

1. LMW
2. Cytoplasmic extract of *E. coli* expressing GST-tagged protein, 1 g cell paste/10 mL
3. GST-tagged protein eluted from GSTrap 1 mL
4. GST-tagged protein eluted from GSTrap 5 mL
5. GST-free target protein eluted from GSTrap 1 mL after 16 h thrombin cleavage
6. Free GST eluted from GSTrap 1 mL after thrombin cleavage
7. Thrombin solution (20 U/mL)
8. LMW

**Fig 5.21.** On-column thrombin cleavage of a GST-tagged protein. (A) Equilibration, sample application, and washing of a GST-tagged protein on GSTrap FF 1 mL were performed using ÄKTA chromatography system. After washing, the column was filled by syringe with 1 mL of thrombin (20 U/mL) and incubated for 16 h at room temperature. (B) GST-free target protein was eluted using PBS, pH 7.3. GST was eluted using 10 mM reduced glutathione. (C) SDS-PAGE followed by silver staining. The GST-free target protein fraction also contained a small amount of thrombin not detectable by SDS-PAGE (lane 6). The thrombin can be removed using a HiTrap Benzamidine FF (high sub) column.



## Cleavage and purification of GST-tagged protein eluted from GSTrap FF

### Recommended buffers

Binding buffer: PBS: 140 mM NaCl, 2.7 mM KCl, 10 mM Na<sub>2</sub>HPO<sub>4</sub>, 1.8 mM KH<sub>2</sub>PO<sub>4</sub>, pH 7.3

#### For PreScission Protease cleavage:

Elution buffer: 50 mM Tris-HCl, 10 mM reduced glutathione, pH 8.0

Cleavage buffer: 50 mM Tris-HCl, 150 mM NaCl, 1 mM EDTA, 1 mM DTT, pH 7.0

PreScission Protease

#### For thrombin cleavage:

Elution buffer: 50 mM Tris-HCl, 10 mM reduced glutathione, pH 8.0

Cleavage buffer: PBS: 140 mM NaCl, 2.7 mM KCl, 10 mM Na<sub>2</sub>HPO<sub>4</sub>, 1.8 mM KH<sub>2</sub>PO<sub>4</sub>, pH 7.3

Thrombin solution: Dissolve 500 units in 0.5 mL of PBS prechilled to 4°C. Swirl gently. Store solution in small aliquots at -80°C to preserve activity.

#### For Factor Xa cleavage:

Elution buffer: 50 mM Tris-HCl, 10 mM reduced glutathione, pH 8.0

Cleavage buffer: 50 mM Tris-HCl, 150 mM NaCl, 1 mM CaCl<sub>2</sub>, pH 7.5

Factor Xa solution: Dissolve 400 units of Factor Xa in 4°C water to give a final solution of 1 unit/μL. Swirl gently. Store solution in small aliquots at -80°C to preserve activity.

## Purification and cleavage



The protocol below is an example optimized for 8 mg of target protein. It is worth estimating how much target protein is applied to the column, as this allows one to minimize the amount of protease added.

1. Fill the syringe or pump tubing with distilled water. Remove the stopper and connect the column to the syringe (use the connector supplied), laboratory pump, or chromatography system "drop to drop" to avoid introducing air into the system.
2. Remove the snap-off end at the column outlet.
3. Wash out the ethanol with 3 to 5 column volumes of distilled water.
4. Equilibrate the column with at least 5 column volumes of binding buffer. Recommended flow rates are 1 mL/min (1 mL column) and 5 mL/min (5 mL column).
5. Apply the pretreated sample using a syringe fitted to the Luer connector or by pumping it onto the column. For best results, use a flow rate of 0.2 to 1 mL/min (1 mL column) and 0.5 to 5 mL/min (5 mL column) during sample application.
6. Wash with binding buffer (generally at least 5 to 10 column volumes) until the absorbance reaches a steady baseline or no material remains in the effluent. Maintain a flow rate of 1 to 2 mL/min (1 mL column) and 5 to 10 mL/min (5 mL column) for washing.
7. Elute the GST-tagged protein with 5 to 10 column volumes of elution buffer. Maintain flow rates of 1 to 2 mL/min (1 mL column) or 1 to 5 mL/min (5 mL column). Collect the eluate (0.5 to 1 mL/tube for 1 mL column, 1 to 2 mL/tube for 5 mL column). Pool fractions containing the GST-tagged protein (monitored by UV absorption at A<sub>280</sub>).
8. Remove the free reduced glutathione from the eluate using a quick buffer exchange on a desalting column (see Chapter 11), depending on the sample volume.



- 9a. For PreScission Protease, add 1  $\mu\text{L}$  (2 units) of PreScission Protease for each 100  $\mu\text{g}$  of tagged protein in the buffer-exchanged eluate.
- 9b. For thrombin and Factor Xa, add 10  $\mu\text{L}$  (10 units) of thrombin or Factor Xa solution for each mg of tagged protein in the buffer-exchanged eluate.
- 10a. For PreScission Protease, incubate at 5°C for 4 h.
- 10b. For thrombin and Factor Xa, incubate at room temperature (22°C to 25°C) for 2 to 16 h.

 The incubation times are starting points and may need to be changed for an optimal yield of cleaved target protein.

- 11. Once digestion is complete, apply the sample to an equilibrated GStrap FF column as described above (steps 1 to 6) to remove the GST moiety of the tagged protein.

**For PreScission Protease:** The flowthrough will contain the protein of interest, while the GST moiety of the tagged protein and the PreScission Protease will remain bound to the GStrap column. This means that the protein of interest will not be contaminated with protease and thus no additional purification will be required to purify the target protein from the protease.

**For thrombin and Factor Xa:** The flowthrough will contain the protein of interest and thrombin or Factor Xa, respectively, while the GST moiety of the tagged protein will remain bound to the GStrap column. The thrombin or Factor Xa can be removed from the protein of interest in one step using a HiTrap Benzamidine FF (high sub) column in series after the GStrap column. In this process, the cleaved, tagged protein and thrombin or Factor Xa is washed from the GStrap column onto the HiTrap Benzamidine FF (high sub) column. This second column captures the thrombin or Factor Xa, thus enabling the collection of pure protease-free protein in the eluent. See *Removal of thrombin and Factor Xa using HiTrap Benzamidine FF (high sub)* for the procedure.

See Appendix 2 for details on regenerating the GStrap column for subsequent purifications.

## Cleavage and purification of GST-tagged protein bound to Glutathione Sepharose in batch mode

Glutathione Sepharose High Performance, Glutathione Sepharose 4 Fast Flow, and Glutathione Sepharose 4B can all be used for cleavage and purification of GST-tagged proteins in batch.

### Recommended buffers

Binding buffer: PBS: 140 mM NaCl, 2.7 mM KCl, 10 mM  $\text{Na}_2\text{HPO}_4$ , 1.8 mM  $\text{KH}_2\text{PO}_4$ , pH 7.3

#### For PreScission Protease cleavage:

Elution buffer: 50 mM Tris-HCl, 10 mM reduced glutathione, pH 8.0

Cleavage buffer: 50 mM Tris-HCl, 150 mM NaCl, 1 mM EDTA, 1 mM DTT, pH 7.0

PreScission Protease

#### For thrombin cleavage:

Elution buffer: 50 mM Tris-HCl, 10 mM reduced glutathione, pH 8.0

Cleavage buffer: PBS: 140 mM NaCl, 2.7 mM KCl, 10 mM  $\text{Na}_2\text{HPO}_4$ , 1.8 mM  $\text{KH}_2\text{PO}_4$ , pH 7.3

Thrombin solution: Dissolve 500 units in 0.5 mL of PBS prechilled to 4°C. Swirl gently. Store solution in small aliquots at -80°C to preserve activity.

#### For Factor Xa cleavage:

Elution buffer: 50 mM Tris-HCl, 10 mM reduced glutathione, pH 8.0


Cleavage buffer: 50 mM Tris-HCl, 150 mM NaCl, 1 mM  $\text{CaCl}_2$ , pH 7.5

Factor Xa solution: Dissolve 400 units of Factor Xa in 4°C distilled water to give a final solution of 1 unit/ $\mu\text{L}$ . Swirl gently. Store solution in small aliquots at -80°C to preserve activity.

## Preparation of Glutathione Sepharose chromatography media and binding of protein


Glutathione Sepharose media are supplied in 20% ethanol. The media are used at a final slurry concentration of 50%.

1. Determine the bed volume of Glutathione Sepharose required for your purification.
2. Gently shake the bottle to resuspend the slurry.
3. Use a pipette or measuring cylinder to remove sufficient slurry for use and transfer to an appropriate container/tube.
4. Sediment the chromatography medium by centrifugation at  $500 \times g$  for 5 min. Carefully decant the supernatant.
5. Wash the Glutathione Sepharose by adding 5 mL of PBS per 1 mL of 50% slurry.


 Glutathione Sepharose must be thoroughly washed with PBS to remove the ethanol storage solution because residual ethanol may interfere with subsequent procedures.

6. Sediment the chromatography medium by centrifugation at  $500 \times g$  for 5 min. Carefully decant the supernatant.
7. Repeat steps 5 and 6 once for a total of two washes.
8. Add the cell lysate to the prepared Glutathione Sepharose and incubate for at least 30 min at room temperature, using gentle agitation such as end-over-end rotation.

## Purification and cleavage

 Assume 8 mg of GST-tagged protein bound per mL of chromatography medium.

1. Wash the tagged-protein-bound Glutathione Sepharose with 10 bed volumes of cleavage buffer. Bed volume is equal to  $0.5 \times$  the volume of the 50% Glutathione Sepharose slurry used.
  - 2a. Prepare the PreScission Protease mix:  
For each mL of Glutathione Sepharose bed volume, prepare a mixture of 80  $\mu$ L (160 units) of PreScission Protease and 920  $\mu$ L of cleavage buffer at 5°C.
  - 2b. Prepare the thrombin mix:  
For each mL of Glutathione Sepharose bed volume, prepare a mixture of 80  $\mu$ L (80 units) of thrombin and 920  $\mu$ L of cleavage buffer.
  - 2c. Prepare the Factor Xa mix:  
For each mL of Glutathione Sepharose bed volume, prepare a mixture of 80  $\mu$ L (80 units) of Factor Xa and 920  $\mu$ L of cleavage buffer.
3. Add the mixture to the Glutathione Sepharose. Gently shake or rotate the suspension end-over-end.
  - 4a. For PreScission Protease, incubate at 5°C for 4 h.
  - 4b. For thrombin or Factor Xa, incubate at room temperature (22°C to 25°C) for 2 to 16 h.

 The incubation times in steps 4a and 4b are starting points and may need to be changed for an optimal yield of cleaved target protein.

5. Following incubation, wash out the untagged protein with approximately three bed volumes of cleavage buffer. Centrifuge the suspension at  $500 \times g$  for 5 min to pellet the Glutathione Sepharose. Carefully transfer the eluate to a tube.

**For PreScission Protease:** The eluate will contain the protein of interest, while the GST moiety of the tagged protein and the PreScission Protease will remain bound to the Glutathione Sepharose. This means that the protein of interest will not be contaminated with protease and thus no additional purification will be required to purify the target protein from the protease.

**For thrombin and Factor Xa:** The eluate will contain the protein of interest and thrombin or Factor Xa, respectively, while the GST moiety of the tagged protein will remain bound to the Glutathione Sepharose. The thrombin or Factor Xa can be removed from the protein of interest using HiTrap Benzamidine FF (high sub). This column captures the thrombin or Factor Xa, thus enabling the collection of pure protease-free protein in the eluent. See procedure below.

## Removal of thrombin and Factor Xa using HiTrap Benzamidine FF (high sub)

### Reagents required

Binding buffer: 0.05 M Tris-HCl, 0.5 M NaCl, pH 7.4

Elution buffer alternatives for eluting the protease:

0.05 M glycine-HCl, pH 3.0

10 mM HCl, 0.5 M NaCl, pH 2.0


20 mM p-aminobenzamidine in binding buffer (competitive elution)

8 M urea or 6 M Gua-HCl (denaturing solutions)

 Recommended flow rates are 1 mL/min (1 mL column) or 5 mL/min (5 mL column).

1. Fill the syringe or pump tubing with distilled water. Remove the stopper and connect the column to the syringe (use the connector supplied), laboratory pump, or chromatographic system “drop to drop” to avoid introducing air into the column.
2. Remove the snap-off end.
3. Wash the column with 5 column volumes of distilled water to remove the storage buffer (0.05 M acetate buffer, pH 4, containing 20% ethanol).

4. Equilibrate the column with 5 column volumes of binding buffer.
5. Apply the sample using a syringe fitted to the Luer connector or by pumping it onto the column. Recommended flow rates for sample application are 1 mL/min for 1 mL column and 5 mL/min for 5 mL column. Collect the flowthrough and reserve. It contains the protease-depleted material to be saved. Apply a small volume of extra binding buffer to collect all desired material from the column.
6. Wash the column with 5 to 10 column volumes of binding buffer, collecting fractions (0.5 to 1 mL fractions for 1 mL column and 1 to 3 mL fractions for 5 mL column) until no material appears in the effluent (monitored by UV absorption at 280 nm).
7. Pool fractions from flowthrough and/or wash that contain the thrombin- or Factor Xa-free material (monitored by UV absorption at 280 nm).
8. For reuse of column, elute the bound protease with 5 to 10 column volumes of the elution buffer of choice. If the eluted thrombin or Factor Xa is to be retained for reuse, buffer exchange the fractions containing the protease using a desalting column (see Chapter 11).  
If a low pH elution buffer has been used, collect fractions in neutralization buffer.
9. After all protease has been eluted, wash the column with binding buffer so it is ready for reuse.

 Thrombin activity can be followed by taking aliquots of the fractions and measuring at 405 nm using S-2238 (Chromogenix, Haemochrom Diagnostica AB; supplier in US is DiaPharma) as substrate.



## Troubleshooting of cleavage methods

The troubleshooting guide below addresses problems common to the majority of cleavage methods as well as problems specific to a particular method. In the latter case, the relevant method is indicated.

Problem	Possible cause	Solution
GST-tagged proteins are not cleaved completely	The ratios of PreScission Protease, thrombin, or Factor Xa to GST-tagged protein are not optimal.	Check that the amount of tagged protein does not exceed the capacity of the Glutathione Sepharose chromatography medium. In most purifications, however, the medium is not saturated with tagged protein. Verify that the correct ratios of enzyme to protein are used and adjust as necessary. For PreScission Protease and thrombin, use at least 10 units/mg of tagged protein. For Factor Xa, use an amount equivalent to at least 1% (w/w) of the weight of tagged protein. For some tagged proteins, up to 5% Factor Xa can be used. The optimal amount must be determined empirically. In some cases, optimal results have been achieved with a tagged protein concentration of 1 mg/mL. The addition of ~0.5% SDS (w/v) to the reaction buffer can significantly improve Factor Xa cleavage with some tagged proteins. Various concentrations of SDS should be tested to determine the optimal concentration. Alternatively, increase incubation time.
	The incubation time and/or enzyme concentration is not sufficient for complete cleavage of the protein from the GST tag.	Increase the incubation time for the cleavage reaction. Increasing the reaction time to 20 h or more should improve cleavage as long as the tagged protein is not degraded by the extended incubation period. Alternatively, try increasing the amount of enzyme used for cleavage.
	Specific cleavage sites for the proteases have been altered during cloning of the tagged protein.	Verify the presence of specific enzyme cleavage sites. Check the DNA sequence of the construct and compare it with a known sequence to verify that the cleavage sites have not been altered.
	The presence of cleavage enzyme inhibitors is interfering with the cleavage reaction.	Remove any enzyme inhibitors that may interfere with the cleavage reaction. Prior to cleavage with PreScission Protease, buffer exchange or dialyze the tagged protein against 50 mM Tris-HCl, 150 mM NaCl, 1 mM EDTA, 1 mM DTT, pH 7.5. Prior to cleavage with Factor Xa, buffer exchange the tagged protein on a desalting column (see Chapter 11), or dialyze against 50 mM Tris-HCl, 150 mM NaCl, 1 mM CaCl <sub>2</sub> , pH 7.5.
	Factor Xa is not properly activated.	Factor Xa protease is preactivated. If using a protease from another source, activate Factor Xa protease with Russell's viper venom to generate functional enzyme. For activation of Factor Xa protease, incubate Russell's viper venom with Factor Xa protease at a ratio of 1% in 8 mM Tris-HCl, 70 mM NaCl, 8 mM CaCl <sub>2</sub> , pH 8.0. Incubate at 37°C for 5 min.
	The first amino acid after the Factor Xa protease recognition sequence is Arg or Pro.	Check the sequence of the tagged protein to verify that the first three nucleotides after the Factor Xa protease recognition sequence do not code for Arg or Pro.

*continues on following page*

<b>Problem</b>	<b>Possible cause</b>	<b>Solution</b>
Multiple bands are observed after electrophoresis/ Western blotting analysis of the cleaved target protein	<p>Proteolysis is occurring in the host bacteria prior to the cleavage reaction.</p> <p>The tagged protein itself contains recognition sequences for PreScission Protease, thrombin protease, or Factor Xa protease.</p>	<p>Determine when the extra bands appear.</p> <p>Verify that additional bands are not present prior to PreScission Protease, thrombin, or protease Factor Xa protease cleavage.</p> <p>Check the sequence of the tagged protein to determine if it contains recognition sequences for the cleavage enzymes.</p>
The tagged partner is contaminated with protease after purification	Glutathione Sepharose may have been saturated with GST-tagged protein during purification.	Pass the sample over a new GSTrap column or fresh Glutathione Sepharose to remove residual PreScission protease, or over a HiTrap Benzamidine (high sub) column in the case of thrombin protease or Factor Xa protease.

**06**

# **Purification of MBP-tagged recombinant proteins**



Dextrin Sepharose High Performance is a chromatography medium for purifying recombinant proteins tagged with maltose binding protein (MBP). Tagging proteins with MBP often gives increased expression levels and higher solubility of the target protein. Proper folding of the attached protein has also been shown to be promoted by the MBP tag. This may decrease the risk of obtaining inclusion bodies when the tagged protein is over-expressed.

Affinity purification using Dextrin Sepharose High Performance takes place under physiological conditions, with mild elution performed using maltose. These mild elution conditions preserve the activity of the target protein. Even intact protein complexes may be purified. In addition, high binding capacity and high specificity of binding mean that good yields of highly pure protein can be achieved in just one step.

Dextrin Sepharose High Performance is available in 25 mL and 100 mL lab packs and prepacked in 1 mL and 5 mL MBPTrap HP columns (Fig 6.1).

## Purification using Dextrin Sepharose High Performance

Dextrin Sepharose High Performance is a robust, high-resolution chromatography medium based on the 34  $\mu\text{m}$  Sepharose High Performance. The small, evenly sized beads ensure that MBP-tagged proteins elute in narrow peaks, thus minimizing the need for further concentration steps. Dextrin Sepharose High Performance tolerates all commonly used aqueous buffers and is easily regenerated using 0.5 M NaOH, allowing the same column to be used for repeated purifications. Table A3.1 (see Appendix 3) summarizes the characteristics of Dextrin Sepharose High Performance.





**Fig 6.1.** Dextrin Sepharose High Performance, also prepacked as MBPTrap HP columns, allows fast and convenient affinity purifications of recombinant proteins tagged with MBP.

## Column packing

See instructions supplied with the product or refer to Appendix 6 for general guidelines for column packing.

## Sample preparation

 Adjust the sample to the composition of the binding buffer (see below). For example, dilute the sample with binding buffer or buffer exchange using a desalting column (see Chapter 11).

 Pass the sample through a 0.22 µm or a 0.45 µm filter and/or centrifuge it immediately before applying it to the column. If the sample is too viscous, to prevent it from clogging the column dilute it with binding buffer, increase lysis treatment (sonication, homogenization), or add DNase/RNase to reduce the size of nucleic acid fragments.

## Buffer preparation


Binding buffer:	20 mM Tris-HCl, 200 mM NaCl, 1 mM EDTA, pH 7.4
Optional:	1 mM DTT
Elution buffer:	10 mM maltose in binding buffer
Regeneration buffer:	0.5 M NaOH (see Appendix 3) or 0.1% SDS


Water and chemicals used for buffer preparation should be of high purity. Filter buffers through a 0.22 µm or a 0.45 µm filter before use.

## Purification

The recommended flow velocity is 150 cm/h.

1. Remove the stoppers and connect the column to the system. Avoid introducing air into the column.
2. If the column has been stored in 20% ethanol, wash out the ethanol with at least 5 column volumes of distilled water or binding buffer at a flow velocity of 50 to 100 cm/h.
3. Equilibrate the column with at least 5 column volumes of binding buffer.
4. Apply the pretreated sample. A lower flow rate can be used during sample application to optimize performance.
5. Wash with 5 to 10 column volumes of binding buffer or until no material appears in the effluent.
6. Elute with 5 column volumes of elution buffer. The buffer conditions of the eluted fractions can be adjusted using a prepacked desalting column (see Chapter 11).
7. After elution, regenerate the column by following the procedure described in Appendix 3.

 Scale-up is typically performed by keeping bed height and flow velocity (cm/h) constant while increasing bed diameter and volumetric flow rate (mL/min). See Figure 6.7 for an example of scale-up using this medium.

 Store Dextrin Sepharose High Performance in 20% ethanol at 2°C to 8°C. After storage, equilibrate with binding buffer before use.



## Purification using MBPTrap HP columns

MBPTrap HP 1 mL and 5 mL columns (Fig 6.2) are made of biocompatible polypropylene that does not interact with biomolecules. Prepacked MBPTrap HP columns provide fast, simple, and easy separations in a convenient format. They can be operated with a syringe, a laboratory pump, or a liquid chromatography system such as ÄKTA.

MBPTrap HP columns are delivered with a stopper on the inlet and a snap-off end on the outlet. Porous top and bottom frits allow high flow rates. MBPTrap HP columns belong to the HiTrap family of prepacked columns. Note that HiTrap columns cannot be opened or refilled.

Table A3.2 (see Appendix 3) summarizes the characteristics of prepacked MBPTrap HP columns.

### Sample preparation

- Adjust the sample to the composition of the binding buffer (see below). For example, dilute the sample with binding buffer or buffer exchange using a desalting column (see Chapter 11).
- Pass the sample through a 0.22  $\mu\text{m}$  or a 0.45  $\mu\text{m}$  filter and/or centrifuge it immediately before applying it to the column. If the sample is too viscous, to prevent it from clogging the column dilute it with binding buffer, increase lysis treatment (sonication, homogenization), or add DNase/RNase to reduce the size of nucleic acid fragments.

### Buffer preparation

Binding buffer:	20 mM Tris-HCl, 200 mM NaCl, 1 mM EDTA, pH 7.4
Optional:	1 mM DTT
Elution buffer:	10 mM maltose in binding buffer
Regeneration buffer:	0.5 M NaOH (see Appendix 3) or 0.1% SDS

- Water and chemicals used for buffer preparation should be of high purity. Filter buffers through a 0.22  $\mu\text{m}$  or a 0.45  $\mu\text{m}$  filter before use.



**Fig 6.2.** MBPTrap HP 1 mL and 5 mL columns give fast and convenient affinity purifications of recombinant proteins tagged with MBP.




## Purification

MBPTrap HP columns can be operated with a syringe, a laboratory pump, or a liquid chromatography system such as ÄKTA.

1. Fill the syringe or pump tubing with binding buffer. Remove the stopper and connect the column to the syringe (with the connector provided) or pump tubing “drop to drop” to avoid introducing air into the column.
2. Remove the snap-off end at the column outlet. Wash out the ethanol with at least 5 column volumes of distilled water or binding buffer.
3. Equilibrate the column with at least 5 column volumes of binding buffer at 1 mL/min or 5 mL/min for 1 mL and 5 mL columns, respectively.
4. Apply the sample using a syringe fitted to the Luer connector or by pumping it onto the column<sup>1</sup>.
5. Wash with 5 to 10 column volumes of binding buffer or until no material appears in the effluent.
6. Elute with 5 column volumes of elution buffer. The eluted fractions can be buffer exchanged using a prepacked desalting column (see Chapter 11).
7. After elution, regenerate the column by following the procedure described in Appendix 3.

<sup>1</sup> A lower flow rate (0.5 mL/min or 2.5 mL/min for 1 mL and 5 mL columns, respectively) can be used during sample application to optimize performance. The correlation between flow rate and number of drops is: a rate of 0.5 mL/min corresponds to approximately 15 drops/min when using a syringe with a HiTrap 1 mL column, and 2.5 mL/min corresponds to approximately 60 drops/min when using a HiTrap 5 mL column.

 Scaling up from 1 mL to 5 mL MBPTrap HP columns is easily performed by increasing sample load and flow rate five-fold. An alternative method for quick scale-up is to connect two or three MBPTrap HP columns in series (back pressure will increase). See Figure 6.7 for an example of scale-up using this medium.

 MBPTrap HP columns are easily cleaned with 0.5 M NaOH.

 Store MBPTrap HP columns in 20% ethanol at 2°C to 8°C. After storage, equilibrate with binding buffer before use.

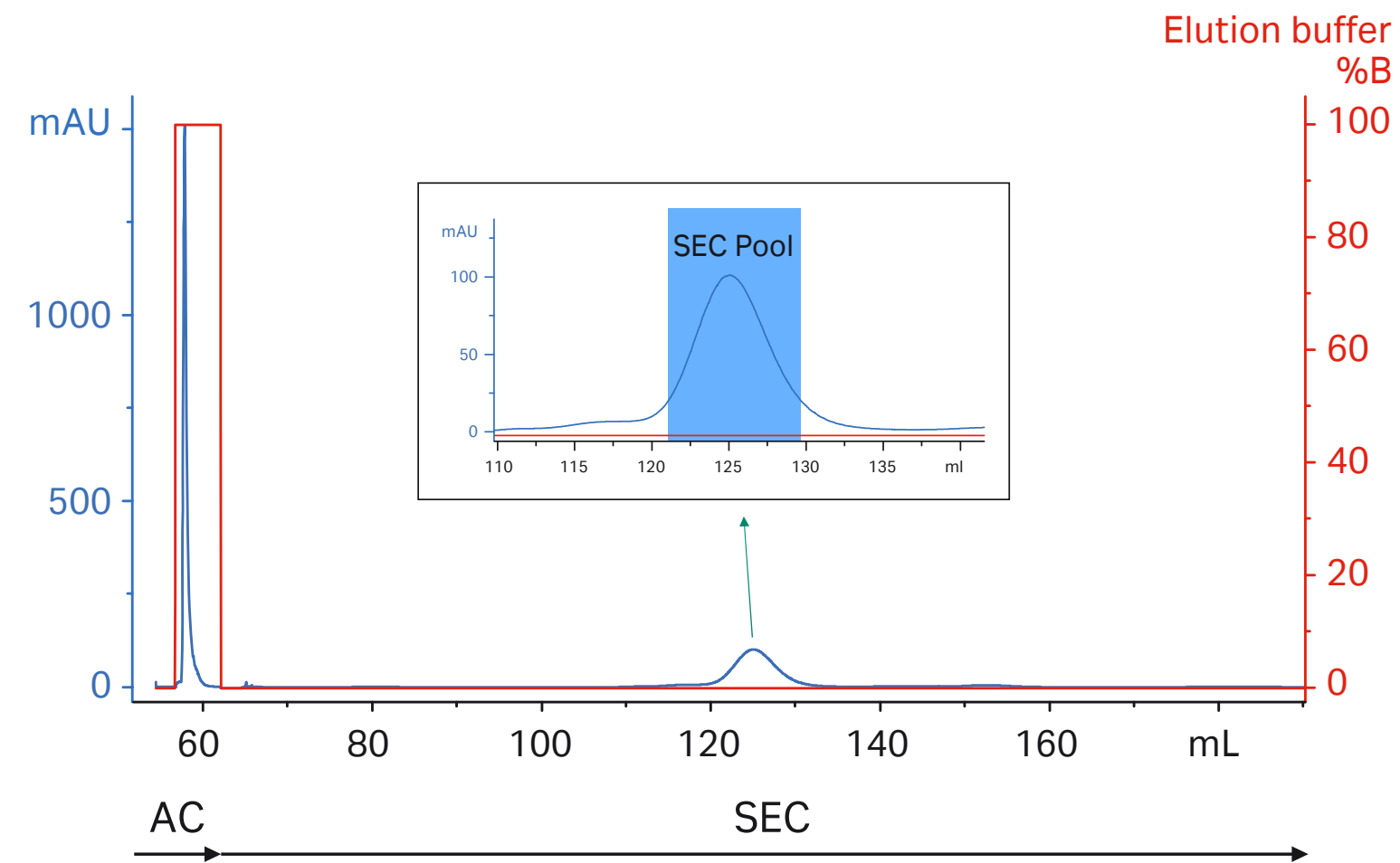
## Application examples

### 1. Automated two-step purification on ÄKTExpress

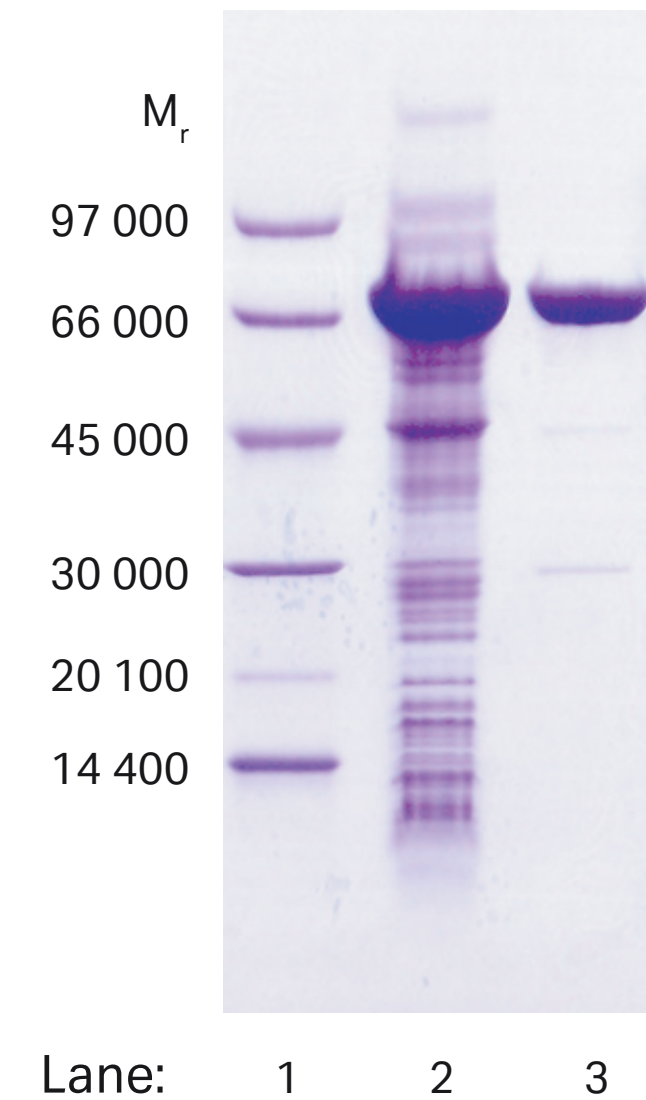
MBPTrap HP 1 mL was used as the first affinity step in an automated two-step purification on ÄKTExpress. The second step, SEC, was run on HiLoad 16/60 Superdex 200 pg. MBP2\*-paramyosin- $\delta$ -Sal ( $M_r$  ~70 000), which exists as a multimer in solution, was purified from *E. coli* lysate. Figure 6.3 shows the running conditions and the resulting chromatogram of the automated purification. Total final yield after the two steps was 2.16 mg, and the overall run time was only 3.4 h. The SDS-PAGE analysis in Figure 6.4 shows the high purity of the pooled fraction from the final SEC step.

**AC column:** MBPTrap HP 1 mL  
**Sample:** MBP2\*-paramyosin- $\delta$ -Sal ( $M_r$  ~70 000) in *E. coli* lysate  
**Sample volume:** 7 mL  
**Flow rate:** 1.0 mL/min (0.5 mL/min during sample application)  
**Binding buffer:** 20 mM Tris-HCl, 200 mM NaCl, 1 mM EDTA, 1 mM DTT, pH 7.4  
**Elution buffer:** 10 mM maltose in binding buffer  
**System:** ÄKTExpress

**SEC column:** HiLoad 16/60 Superdex 200 pg  
**Sample:** Eluted pool from MBPTrap HP 1 mL  
**Flow rate:** 1.5 mL/min  
**Buffer:** 10 mM sodium phosphate, 140 mM NaCl, pH 7.4



**Fig 6.3.** Automated purification of MBP2\*-paramyosin- $\delta$ -Sal using the two-step AC-SEC protocol on MBPTrap HP 1 mL (AC) and HiLoad 16/60 Superdex 200 pg (SEC).



#### Lanes

1. Low molecular weight marker, LMW
2. Start material, MBP2\*-paramyosin- $\delta$ -Sal in *E. coli* lysate
3. Final eluted SEC pool

**Fig 6.4.** SDS-PAGE analysis (reducing conditions) of the purification of MBP2\*-paramyosin- $\delta$ -Sal.

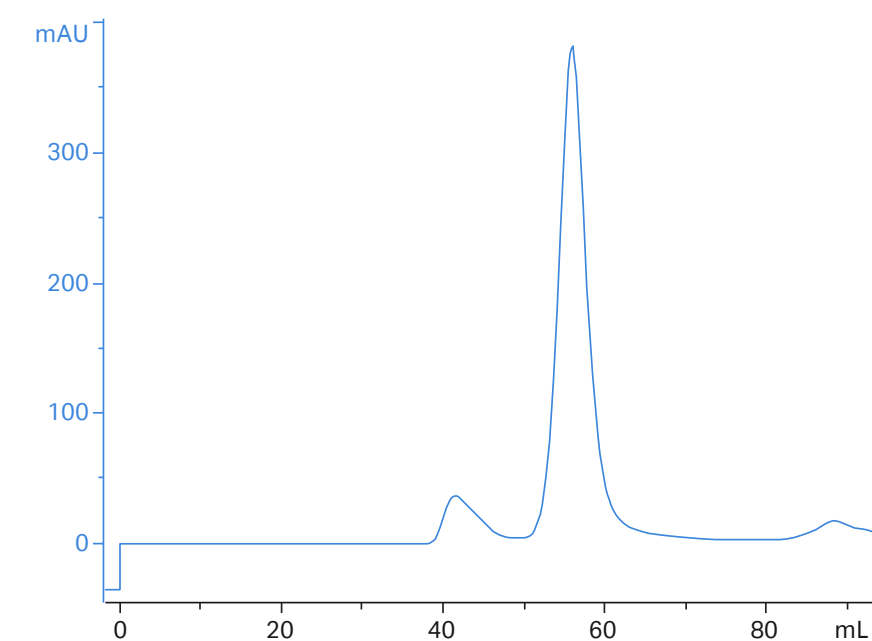
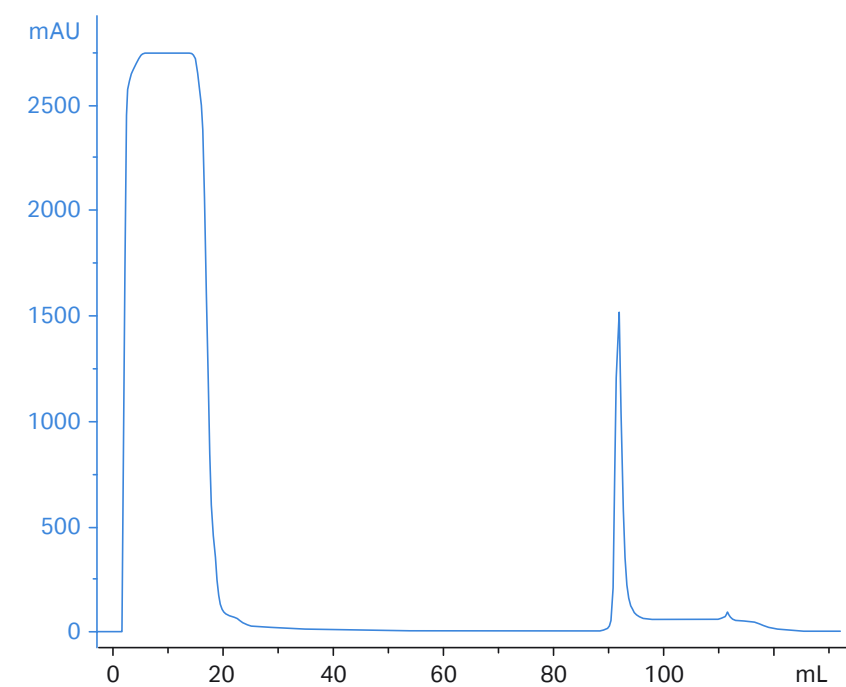
## 2. Purification of a protein involved in metabolic disease

An MBPTrap HP column was used in a purification procedure for medium-chain acyl-CoA dehydrogenase (MCAD). This homotetramer ( $M_r$  85 500), which is involved in metabolic disease, was purified for stability, folding, and kinetic studies (see Fig 6.5). In addition to AC, the purification procedure also included an SEC step.

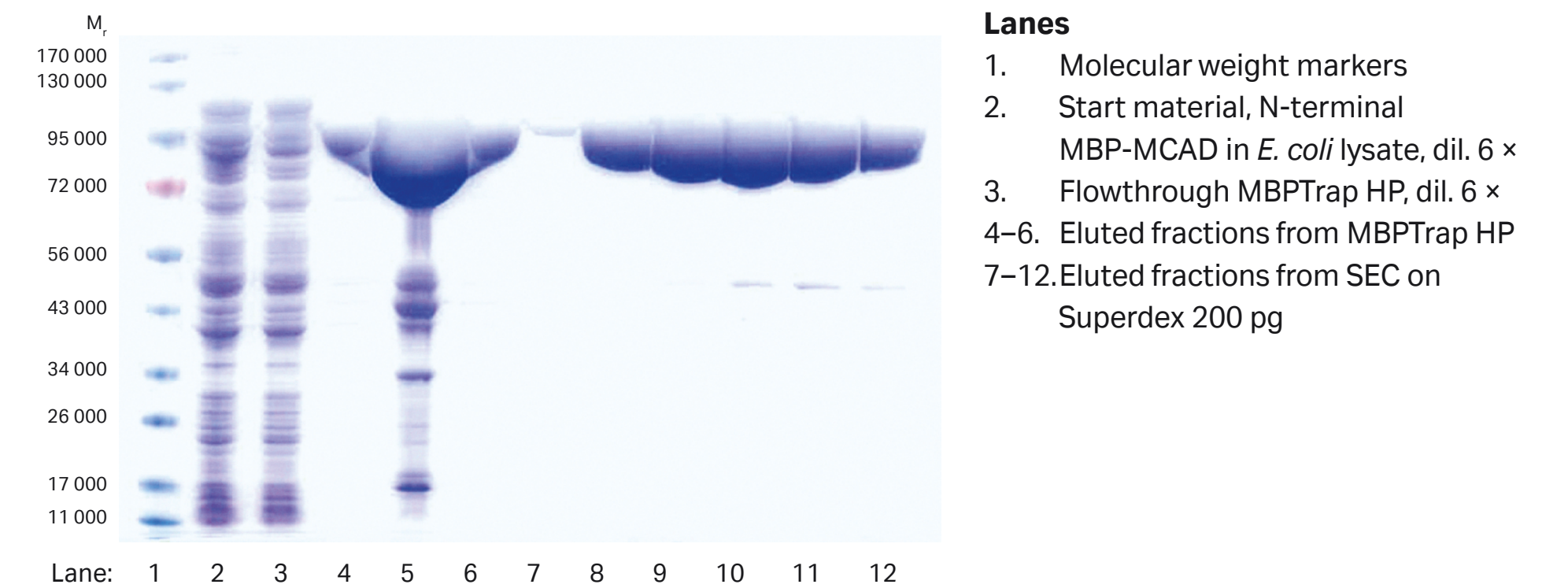
The purity of the eluted fractions from MBPTrap HP and SEC was determined by SDS-PAGE analysis. Some additional proteins besides the target protein were detected after the affinity step. This may be due to the presence of truncated variants still having the N-terminal MBP-tag intact, or possibly *E. coli* proteins associated with the target protein (this was not evaluated further). Final purity after SEC was extremely high according to SDS-PAGE analysis (see Fig 6.6). Final yield was approximately 8.4 mg MCAD.

(A) **Column:** MBPTrap HP 5 mL  
**Sample:** N-terminal MBP-MCAD in *E. coli* lysate  
**Sample volume:** 15 mL  
**Flow rate:** 5.0 mL/min (0.5 mL/min during sample loading)  
**Binding buffer:** 20 mM Tris-HCl, 200 mM NaCl, 1 mM EDTA, 1 mM DTT, pH 7.4  
**Elution buffer:** 10 mM maltose in binding buffer  
**System:** ÄKTA system

(B) **Column:** Superdex 200 pg in XK 16/20  
**Sample:** Eluted fraction from MBPTrap HP 5 mL  
**Sample volume:** 2 mL  
**Flow rate:** 0.4 mL/min  
**Buffer:** 20 mM HEPES, 200 mM NaCl, pH 7.0  
**System:** ÄKTA system



**Fig 6.5.** Purification of MCAD on (A) MBPTrap HP followed by (B) Superdex 200 pg.



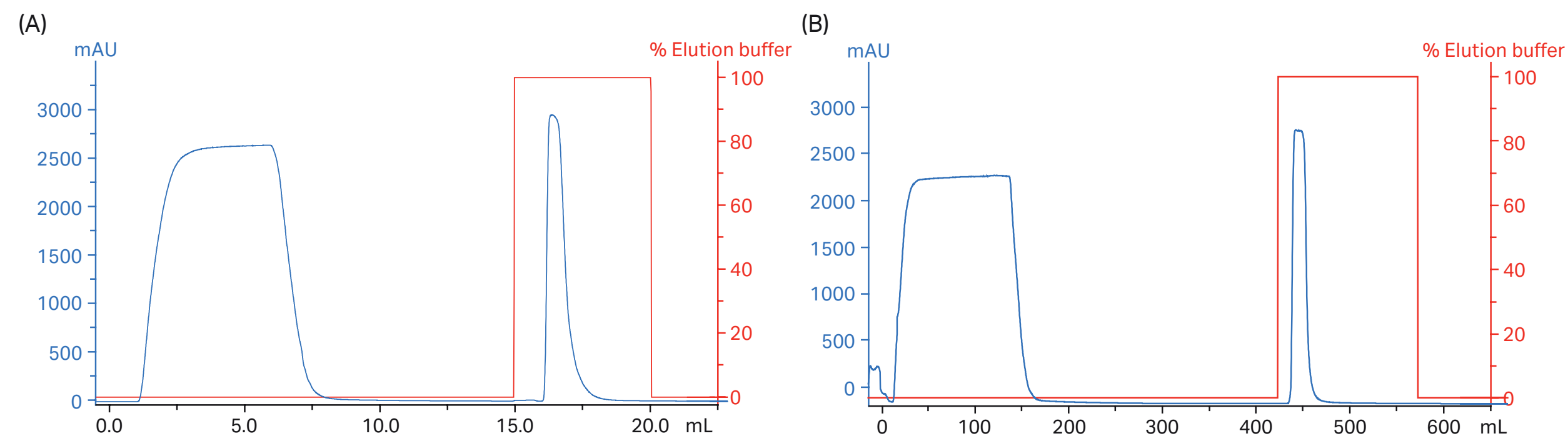
**Fig 6.6.** SDS-PAGE analysis (reducing conditions) of fractions from the two-step purification of MCAD. Data kindly provided by Dr. Esther M. Maier and Dr. von Haunersches Kinderspital, Munich, Germany.



### 3. Scaling up

Scale-up can be achieved by increasing the bed volume while keeping the residence time constant. This approach maintains chromatographic performance during scale-up. MBP2\*- $\beta$ -galactosidase ( $M_r \sim 158\,000$ ), an affinity-tagged multimer, was purified on an MBPTrap HP 1 mL column on an ÄKTA chromatography system. The purification was scaled up on an MBPTrap HP 5 mL and an XK 26/20 column packed with Dextrin Sepharose High Performance. The protein load was increased five-fold in each step ( $\sim 10$ ,  $\sim 50$ , and  $\sim 250$  mg, respectively) and the residence time was  $\sim 2$  min for all three columns. Figure 6.7 shows running conditions for all runs and the chromatograms from the MBPTrap HP 1 mL and Dextrin Sepharose High Performance XK 26/20 runs. Figure 6.8 shows the SDS-PAGE results. The columns gave comparable results with high purity and similar yields (approximately 60%, Table 6.1), confirming the ease and reproducibility of scaling up purifications from MBPTrap HP columns to an XK 26/20 column. An alternative method for quick scale-up is to connect two or three MBPTrap HP columns in series, but this may increase back pressure.

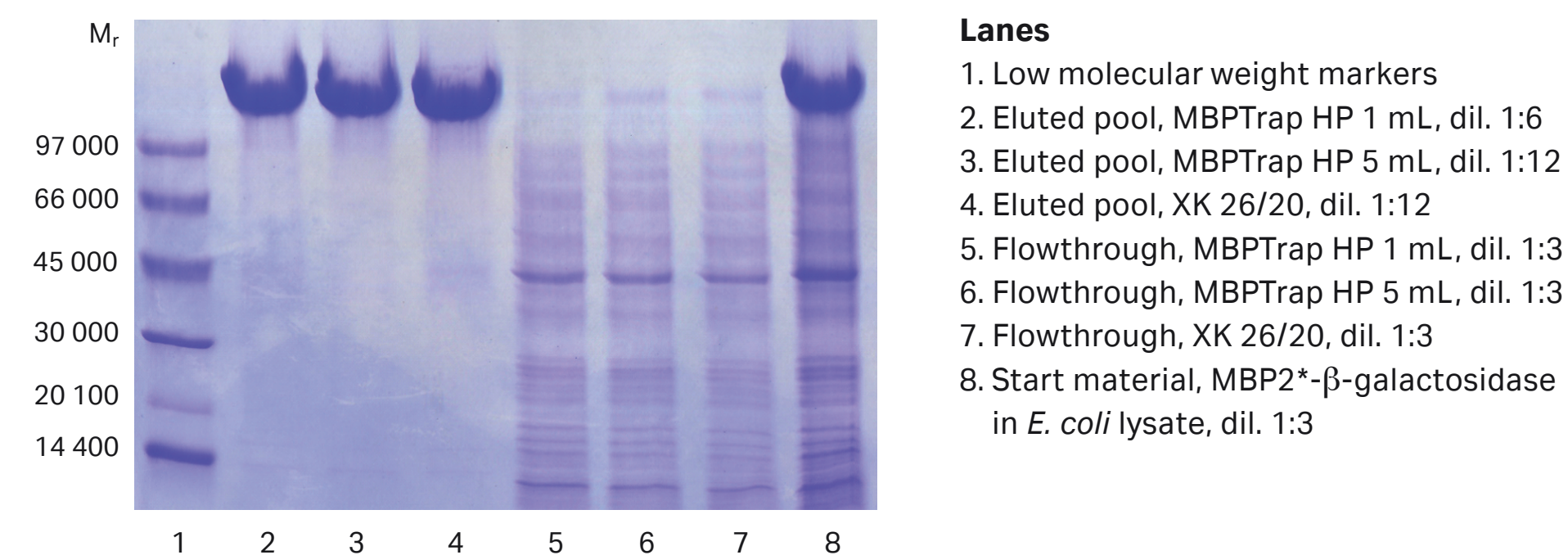
**Columns:** MBPTrap HP 1 mL Dextrin Sepharose High Performance packed in XK 26/20, 29 mL, bed height 5.5 cm  
**Sample:** MBP2\*- $\beta$ -galactosidase ( $M_r \sim 158\,000$ ) in *E. coli* lysate  
**Sample volumes:** 5 mL (MBPTrap HP 1 mL), 125 mL (XK 26/20 column)  
**Binding buffer:** 20 mM Tris-HCl, 200 mM NaCl, 1 mM EDTA, 1 mM DTT, pH 7.4  
**Elution buffer:** 10 mM maltose in binding buffer  
**Flow rates:** MBPTrap HP 1 mL: 1.0 mL/min (0.5 mL/min during sample loading)  
 XK 26/20 column: 13 mL/min  
**System:** ÄKTA



**Fig 6.7.** Scale-up of MBP2\*- $\beta$ -galactosidase purification, (A) MBPTrap HP 1 mL (B) Dextrin Sepharose High Performance XK 26/20, 29 mL. Chromatogram for MBPTrap 5 mL column not shown.

**Table 6.1.** Scaling up using Dextrin Sepharose High Performance

Column	Yield (mg)	Yield (%)	Purity (%)
MBPTrap HP 1 mL	6.4	64	> 95%
MBPTrap HP 5 mL	29.5	59	> 95%
XK 26/20 packed with Dextrin Sepharose High Performance, 29 mL	141.4	57	> 95%



**Fig 6.8.** SDS-PAGE analysis (reducing conditions) of the scale-up study.

# Troubleshooting

Problem	Possible cause	Solution
Increased back pressure	High viscosity of solutions. Insufficient cell disruption.  Freezing/thawing of the unclarified lysate has increased precipitation and aggregation.	Use lower flow rates and/or dilute the sample.  Increase the efficiency of the mechanical cell disruption, e.g., increase sonication time. (Keep the sample on ice during sonication to avoid frothing and overheating as this may denature the target protein. Over-sonication can also lead to co-purification of host proteins with the target protein).  Increase dilution of the cell paste before mechanical lysis, or dilute after lysis to reduce viscosity.  Decrease flow rate during sample loading.  Centrifuge or pass through a 0.22 or 0.45 µm filter before application on the column.
Column has clogged	Top filter is clogged. Cell debris in the sample may have clogged the column.	Change top filter. If using an MBPTrap column, replace the column.  Clean the column according to Appendix 3.  Centrifuge and/or filter the sample through a 0.22 µm or a 0.45 µm filter or otherwise optimize sample pretreatment before loading the next sample.
No or weak binding	Protein found in the flowthrough.  Factors in the crude extract interfere with binding. MBP-tag is not present. MBP-tag is not accessible. Protein has precipitated in the column due to high protein concentration.	Buffer/sample composition is not optimal; check the pH and composition of the sample and binding buffer. pH should in general be above pH 7.  Include glucose in the growth medium to suppress amylose expression.  Use protease-deficient <i>E. coli</i> expression strains. Add protease inhibitors during cell lysis.  Fuse the MBP-tag with the other protein terminus. Use another linker.  Clean the column according to instructions in Appendix 3. In the following run decrease the amount of sample, or decrease protein concentration by eluting with a linear gradient instead of step-wise elution. Try detergents or change the NaCl concentration.  If an MBPTrap HP 1 mL column has been used, change to the larger MBPTrap HP 5 mL. This will reduce the final concentration, provided that the same amount of sample is applied. For quick scale-up, connect two or more columns in series by screwing the end of one column into the top of the next. Note, however, that connecting columns in series will increase back pressure.
Contaminating proteins	Contaminants are short forms of the tagged protein.	Use protease-deficient <i>E. coli</i> expression strains. Add protease inhibitors after cell lysis. Fuse the MBP-tag with the other protein terminus. Check for the presence of internal translation initiation starts (for C-terminal MBP-tag) or premature termination sites (for N-terminal MBP-tag). Use EDTA in the sample and buffers. Keep the sample cold.

continues on following page

Problem	Possible cause	Solution
	<p>Contaminants are covalently linked to the recombinant protein via disulfide bonds.</p> <p>Contaminants are non-covalently linked to the recombinant protein.</p>	<p>Add reducing agents to all buffers for cell lysis and purification. Note that the yield may decrease.</p> <p>Increase ionic strength in all buffers for cell lysis and purification (up to 1 M NaCl) or add mild detergents, 0.1% Tween, 0.1% CHAPS). Be careful since the binding of MBP to dextrin may be affected by the addition of non-ionic detergents.</p>
Unwanted air bubble formation	<p>Unclarified lysates may increase air bubble formation during purification.</p> <p>Air bubbles may form due to decreased air solubility when columns stored at 2°C to 8°C are used immediately at room temperature.</p>	<p>Attaching a flow restrictor in the chromatography system can prevent this. If a flow restrictor is attached, it is important to change the pressure limit to adjust for the extra pressure from the flow restrictor. Do not exceed the pressure limit for the column on the ÄKTA system.</p> <p>Let the columns adapt to room temperature for some minutes before using them.</p>



07

# Purification of *Strep*-tag II recombinant proteins

StrepTactin Sepharose High Performance is a chromatography medium for purifying *Strep*-tag II proteins. *Strep*-tag II binds very specifically to the immobilized *Strep*-Tactin ligand, giving highly pure target protein after purification. In most cases, sufficient purity is obtained in single-step affinity purification. *Strep*-tag II is a small tag consisting of only eight amino acid residues (Trp-Ser-His-Pro-Gln-Phe-Glu-Lys) and having a relative molecular mass ( $M_r$ ) of only 1000. The small size of the tag is beneficial, because in most cases it does not interfere with structural and functional studies and, therefore, does not have to be removed from the target protein after purification. Affinity purification using StrepTactin Sepharose High Performance takes place under physiological conditions, and mild elution with desthiobiotin preserves the activity of the target protein.

StrepTactin Sepharose High Performance is available in 10 and 50 mL lab packs and prepacked in 1 and 5 mL StrepTrap HP columns (Fig 7.1).

## Purification using StrepTactin Sepharose High Performance

StrepTactin is a specially engineered streptavidin ligand. The binding affinity of *Strep*-tag II to the immobilized ligand is nearly 100-fold higher than to streptavidin, making StrepTactin Sepharose High Performance ideal for purifying *Strep*-tag II proteins.

The small bead size (average 34  $\mu\text{m}$ ) of the Sepharose High Performance matrix results in high-resolution separations, sharp peaks, and purified target proteins in a concentrated form. StrepTactin Sepharose High Performance is compatible with a wide range of additives, tolerates all commonly used aqueous buffers, and is quickly and easily regenerated using 0.5 M NaOH. See Appendix 4 for more information on the characteristics of the medium.





**Fig 7.1.** StrepTactin Sepharose High Performance, also prepacked as StrepTrap HP columns, give fast and convenient affinity purifications of *Strep*-tag II recombinant proteins.

## Column packing

See instructions supplied with the product or refer to Appendix 6 for general guidelines for column packing.

## Sample preparation


 Adjust the sample to the composition of the binding buffer (see below). For example, dilute the sample with binding buffer or buffer exchange using a desalting column (see Chapter 11).

 Pass the sample through a 0.22  $\mu\text{m}$  or a 0.45  $\mu\text{m}$  filter and/or centrifuge it immediately before applying it to the column. If the sample is too viscous, to prevent it from clogging the column, dilute it with binding buffer, increase lysis treatment (sonication, homogenization), or add DNase/RNase to reduce the size of nucleic acid fragments.

## Buffer preparation

Binding buffer:	100 mM Tris-HCl, 150 mM NaCl, 1 mM EDTA, pH 8 or PBS (20 mM sodium phosphate, 280 mM NaCl, 6 mM potassium chloride), pH 7.4
Elution buffer:	2.5 mM desthiobiotin in binding buffer
Regeneration buffer:	0.5 M NaOH or 1 mM HABA (2-[4'-hydroxy-benzeneazo] benzoic acid) in binding buffer


See Appendix 4 for details on regeneration of the medium.


 Water and chemicals used for buffer preparation should be of high purity. Filter buffers through a 0.22  $\mu\text{m}$  or a 0.45  $\mu\text{m}$  filter before use.

## Purification

The recommended flow velocity is 150 cm/h.

1. Remove the stoppers and connect the column to the system. Avoid introducing air into the column.
2. If the column has been stored in 20% ethanol, wash out the ethanol with at least 5 column volumes of distilled water or binding buffer at a flow velocity of 50 to 100 cm/h.
3. Equilibrate the column with at least 5 column volumes of binding buffer.
4. Apply the pretreated sample.
5. Wash with 5 to 10 column volumes of binding buffer or until no material appears in the effluent.
6. Elute with ~6 column volumes of elution buffer. The eluted fractions can be buffer exchanged using a prepacked desalting column (see Chapter 11).
7. After elution, regenerate the column by following the procedure described in Appendix 4.

 Scale-up is typically performed by keeping bed height and flow velocity (cm/h) constant while increasing bed diameter and volumetric flow rate (mL/min). See Figure 7.4 for an example of scale-up using this medium.

 Store StrepTactin Sepharose High Performance in 20% ethanol at 2°C to 8°C. After storage, equilibrate with binding buffer before use.



## Purification using StrepTrap HP 1 mL and 5 mL

StrepTrap HP 1 mL and 5 mL columns are made of biocompatible polypropylene that does not interact with biomolecules (Fig 7.2). Prepacked StrepTrap HP columns provide fast, simple, and easy separations in a convenient format. They can be operated with a syringe, a laboratory pump, or a liquid chromatography system such as ÄKTA.

StrepTrap HP columns are delivered with a stopper on the inlet and a snap-off end on the outlet. Porous top and bottom frits allow high flow rates. StrepTrap HP columns belong to the HiTrap family of prepacked columns. Note that HiTrap columns cannot be opened or refilled.

Table A4.3 (see Appendix 4) summarizes the characteristics of prepacked StrepTrap HP columns.

### Sample preparation


Adjust the sample to the composition of the binding buffer (see below). For example, dilute the sample with binding buffer or buffer exchange using a desalting column (see Chapter 11).

Pass the sample through a 0.22  $\mu\text{m}$  or a 0.45  $\mu\text{m}$  filter and/or centrifuge it immediately before applying it to the column. If the sample is too viscous, to prevent it from clogging the column dilute it with binding buffer, increase lysis treatment (sonication, homogenization), or add DNase/RNase to reduce the size of nucleic acid fragments.

### Buffer preparation

Binding buffer:	100 mM Tris-HCl, 150 mM NaCl, 1 mM EDTA, pH 8 or PBS (20 mM sodium phosphate, 280 mM NaCl, 6 mM potassium chloride), pH 7.4
Elution buffer:	2.5 mM desthiobiotin in binding buffer
Regeneration buffer:	0.5 M NaOH or 1 mM HABA (2-[4'-hydroxy-benzeneazo] benzoic acid) in binding buffer

See Appendix 4 for details on regeneration of StrepTrap 1 mL and 5 mL.

 Water and chemicals used for buffer preparation should be of high purity. Filter buffers through a 0.22  $\mu\text{m}$  or a 0.45  $\mu\text{m}$  filter before use.



**Fig 7.2.** StrepTrap HP 1 mL and 5 mL columns quickly and conveniently purify *Strep*-tag II recombinant proteins to high purities in concentrated forms and small volumes.

## Purification

1. Fill the syringe or pump tubing with binding buffer. Remove the stopper and connect the column to the syringe (with the connector provided) or pump tubing "drop to drop" to avoid introducing air into the column.
2. Remove the snap-off end at the column outlet. Wash out the ethanol with at least 5 column volumes of distilled water or binding buffer.
3. Equilibrate the column with at least 5 column volumes of binding buffer at 1 mL/min or 5 mL/min for 1 mL and 5 mL columns, respectively.
4. Apply the sample using a syringe fitted to the Luer connector or by pumping it onto the column.
5. Wash with 5 to 10 column volumes of binding buffer or until no material appears in the effluent.
6. Elute with 6 column volumes of elution buffer. The eluted fractions can be buffer exchanged using a prepacked desalting column (see Chapter 11).
7. After elution, the column can be regenerated by following the procedure described in Appendix 4.

Scaling up from 1 mL to 5 mL StrepTrap HP columns is easily performed by increasing sample load and flow rate five-fold. An alternative method for quick scale-up is to connect two or three StrepTrap HP columns in series (back pressure will increase). See Figure 7.5 for an example of scale-up.

StrepTrap HP columns are fast and are easily regenerated with 0.5 M NaOH.

Store StrepTrap HP columns in 20% ethanol at 2°C to 8°C. After storage, equilibrate with binding buffer before use.

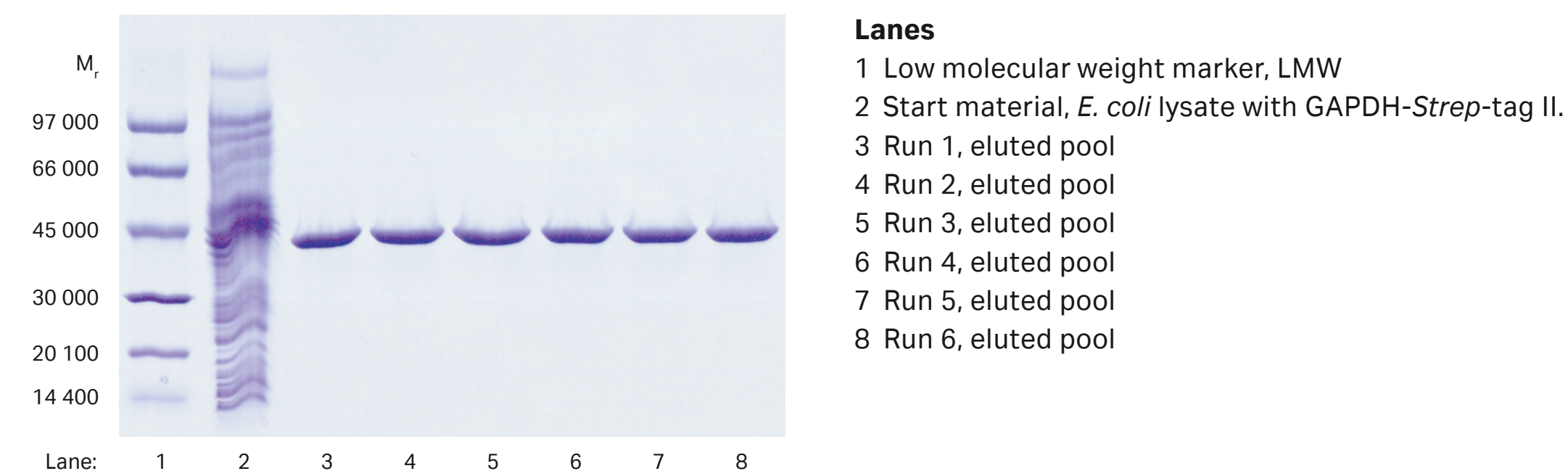
## Application examples

### 1. Rapid and effective regeneration

The regeneration of StrepTrap HP is easily performed using sodium hydroxide (0.5 M NaOH). Six consecutive purifications of glyceraldehyde-phosphodehydrogenase (GAPDH)-Strep-tag II in *E. coli* lysate were performed with regeneration between the runs (Fig 7.3). The load was 1 mg of GAPDH-Strep-tag II.

The final purity and yield of the target protein were almost identical, with no tendency of decreasing values. The purity was above 95% according to SDS-PAGE (Fig 7.3), and the yield was approximately 0.85 mg (85%) for all six runs. These results show the high reproducibility during repeated use of StrepTrap HP in combination with regeneration with 0.5 M NaOH.

Column:	StrepTrap HP 1 mL
Sample:	GAPDH-Strep-tag II in <i>E. coli</i> lysate ( $M_r \sim 37\ 500$ )
Sample volume:	1 mL
Binding buffer:	100 mM Tris-HCl, 150 mM NaCl, 1 mM EDTA, pH 8.0
Elution buffer:	2.5 mM desthiobiotin in binding buffer
Regeneration procedure:	3 mL H <sub>2</sub> O, 3 mL 0.5 M NaOH, 3 mL H <sub>2</sub> O
Flow rate:	1 mL/min (0.5 mL/min for 0.5 M NaOH)
System:	ÄKTA



**Fig 7.3.** Repeated purification and regeneration on the same StrepTrap HP column. SDS-PAGE analysis (reducing conditions, Coomassie stained) of eluted pools from six purification runs on the same StrepTrap HP column including regeneration with 0.5 M NaOH between each run.



## 2. Increased purity with a two-step affinity purification of a dual-tagged protein

In most cases, sufficient purity is obtained in single-step affinity purification of *Strep*-tag II fusion proteins using StrepTactin Sepharose. Should this not be the case, a solution is to introduce a second affinity tag. In this example, a dual-tagged *Strep*-tag II-(histidine)<sub>6</sub> protein ( $M_r \sim 15\,400$ ) expressed in *E. coli* was purified for method development of functional studies. The two-step procedure comprised IMAC on HisTrap HP (prepacked with Ni Sepharose High Performance) followed by AC on StrepTrap HP. As high purity is crucial for successful functional studies, purity results of the two-step method were compared to the IMAC and AC steps individually. All runs were performed on ÄKTExpress at 4°C.

The conditions used are as follows:

### Individual HisTrap HP purification

**Column:** HisTrap HP 1 mL  
**Sample:** *Strep*-tag II-(his)<sub>6</sub> protein ( $M_r \sim 15\,400$ ) in *E. coli* lysate  
**Sample volume:** 15 mL  
**Binding buffer:** 20 mM sodium phosphate, 500 mM NaCl, 20 mM imidazole, pH 7.5  
**Elution buffer:** 20 mM sodium phosphate, 500 mM NaCl, 500 mM imidazole, pH 7.5  
**Flow rate:** 0.8 mL/min  
**System:** ÄKTExpress

### Individual StrepTrap HP purification

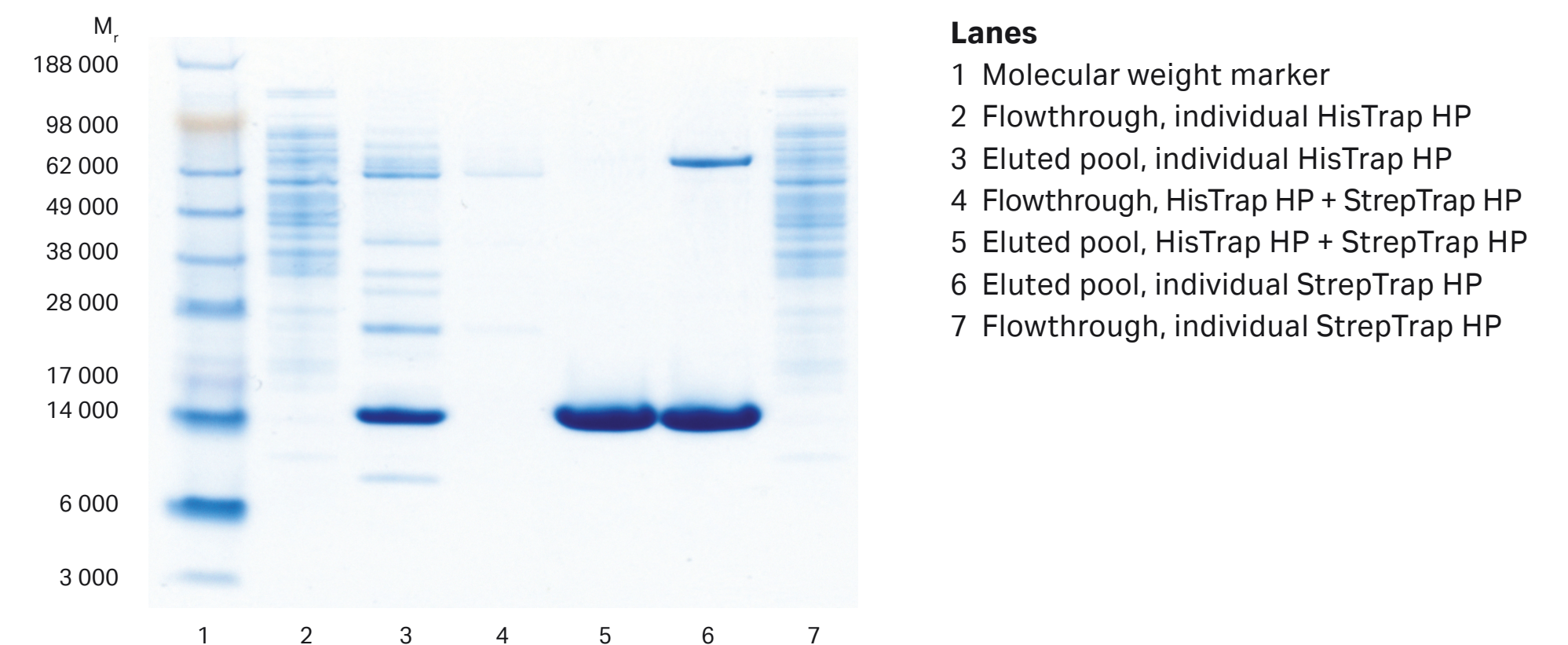
**Column:** StrepTrap HP 1 mL  
**Sample:** *Strep*-tag II-(his)<sub>6</sub> protein ( $M_r \sim 15\,400$ ) in *E. coli* lysate  
**Sample volume:** 15 mL  
**Binding buffer:** 100 mM Tris-HCl, 150 mM NaCl, 1 mM EDTA, pH 8.0  
**Elution buffer:** 2.5 mM desthiobiotin in binding buffer  
**Flow rate:** 0.8 mL/min  
**System:** ÄKTExpress

### Two-step HisTrap HP and StrepTrap HP purification

**Column:** HisTrap HP 1 mL  
**Sample:** *Strep*-tag II-(histidine)<sub>6</sub> protein ( $M_r \sim 15\,400$ ) in *E. coli* lysate  
**Sample volume:** 15 mL  
**Binding buffer:** 20 mM sodium phosphate, 500 mM NaCl, 20 mM imidazole, pH 7.5  
**Elution buffer:** 20 mM sodium phosphate, 500 mM NaCl, 500 mM imidazole, pH 7.5  
**Flow rate:** 0.8 mL/min  
**Column:** StrepTrap HP 1 mL  
**Sample:** Eluted fraction from HisTrap HP, 1 mL  
**Binding buffer:** 100 mM Tris-HCl, 150 mM NaCl, 1 mM EDTA, pH 8.0  
**Elution buffer:** 2.5 mM desthiobiotin in binding buffer  
**Flow rate:** 0.2 mL/min  
**System:** ÄKTExpress

SDS-PAGE analysis (Fig 7.4) showed that the individual HisTrap HP purification yielded the target protein and a number of different impurities (lane 3). StrepTrap HP on its own also yielded the target protein, this time with one impurity (lane 6). In contrast, the combination of HisTrap HP followed by StrepTrap HP resulted in a target protein with a purity greater than 95% (lane 5).

This example clearly demonstrates the benefits of a dual-tagged approach to protein purification, especially when high purity is needed. HisTrap HP and StrepTrap HP run in sequence on ÄKTExpress fulfilled the requirements for a fast and efficient chromatography system capable of delivering such results.



**Fig 7.4.** SDS-PAGE analysis (reducing conditions) comparing individual purifications on HisTrap HP 1 mL and StrepTrap HP 1 mL with a combined, two-step affinity purification on both columns. Data kindly provided by Martina Nilsson, Robert Svensson, and Erik Holmgren, Biovitrum, Stockholm, Sweden.



### 3. Scale-up from 1 mL to 5 mL to 29 mL column

Scale-up can be achieved by increasing the bed volume while keeping the residence time constant. This approach maintains chromatographic performance during scale-up.

The protein used was a dual-tagged fluorescent protein, (his)<sub>6</sub>-mCherry-*Strep*-tag II (M<sub>r</sub> 31 000), in *E. coli* lysate, which can be detected at 587 nm as well as 280 nm. Purification on a StrepTrap HP 1 mL column was first performed and then scaled up to the 5 mL column followed by further scale-up to a 29 mL XK 26/20 column packed with StrepTactin Sepharose High Performance (bed height 5.5 cm). The residence time was ~2 min for all columns. Figure 7.5 shows the chromatograms and running conditions. Figure 7.5 shows the chromatograms and running conditions.

Protein load was increased five-fold for the scale-up from the 1 mL StrepTrap HP column to the 5 mL column and 25-fold in the scale-up from the 1 mL StrepTrap HP column to the 29 mL XK 26/20 column. Yield, calculated from absorbance measurements, was 2.2, 9.4, and 52.7 mg, respectively (Table 7.1). SDS-PAGE (data not shown) showed that the purity of the fractions eluted from the columns was similar.

The columns gave comparable results, confirming the ease and reproducibility of scaling up purifications from StrepTrap HP columns to a larger, XK 26/20 column packed with StrepTactin Sepharose High Performance.

**Table 7.1.** Overview of the yield for StrepTrap HP and XK 26/20 columns

Column	Yield (mg)
StrepTrap HP, 1 mL	2.2
StrepTrap HP, 5 mL	9.4
XK 26/20 packed with StrepTactin Sepharose High Performance, 29 mL	52.7

**Column:** StrepTrap HP 1 mL  
StrepTrap HP 5 mL  
StrepTactin Sepharose High Performance packed in XK 26/20, 29 mL, bed height 5.5 cm

**Sample:** (His)<sub>6</sub>-mCherry-*Strep*-tag II (M<sub>r</sub> ~31 000), in *E. coli* lysate

**Sample volume:** 4.2 mL (StrepTrap HP 1 mL)  
21 mL (StrepTrap HP 5 mL)  
105 mL (XK 26/20 column)

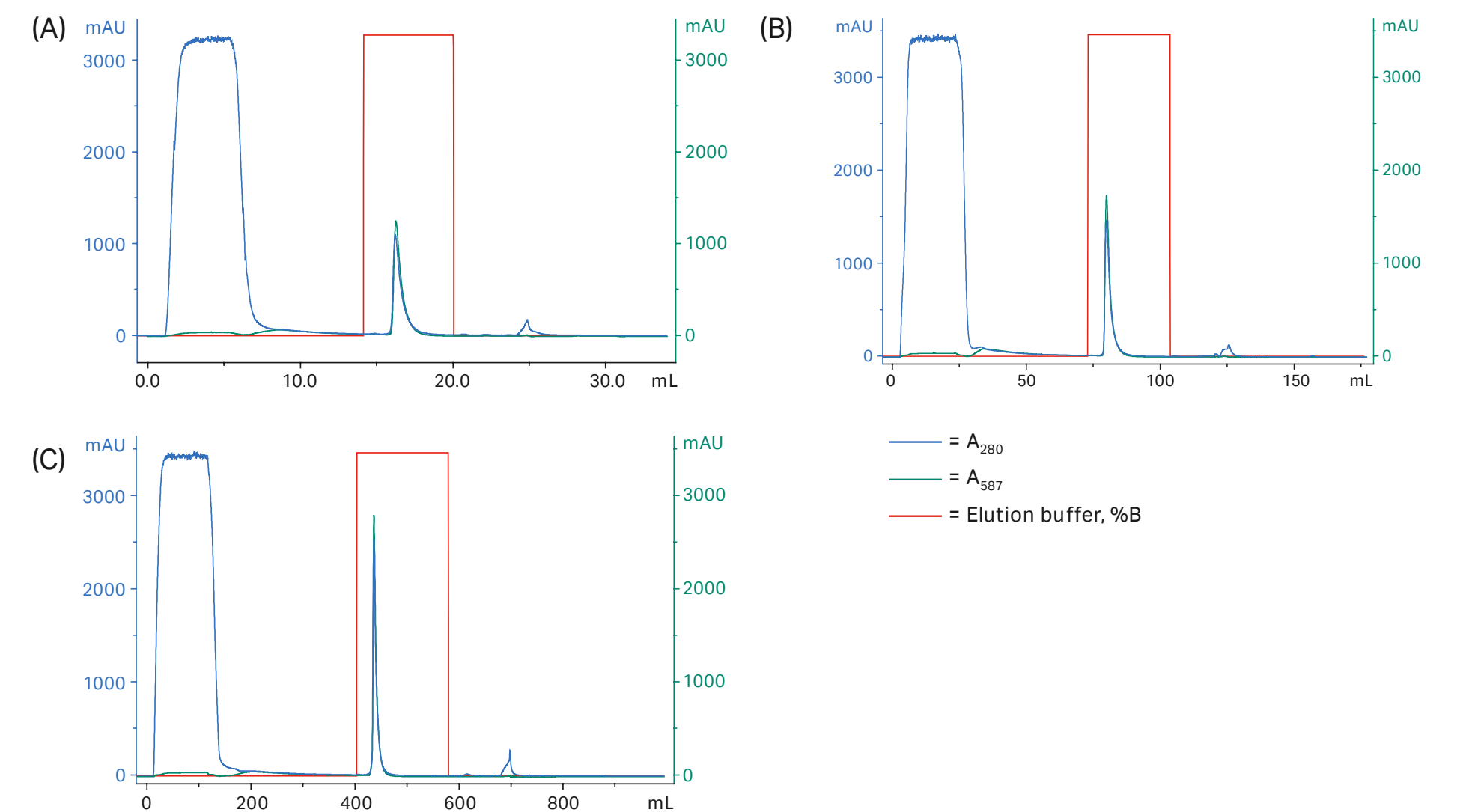
**Regeneration:** 3 column volumes distilled water, 3 column volumes 0.5 M NaOH, 3 column volumes distilled water

**Binding buffer:** 100 mM Tris-HCl, 150 mM NaCl, 1 mM EDTA, pH 8.0

**Elution buffer:** 2.5 mM desthiobiotin in binding buffer

**Flow rate:** StrepTrap HP 1 mL: 1.0 mL/min (0.5 mL/min during sample loading and regeneration with 0.5 M NaOH)  
StrepTrap HP 5 mL: 5.0 mL/min (2.5 mL/min during sample loading and regeneration with 0.5 M NaOH)  
XK 26/20 column: 13 mL/min (6.5 mL/min during regeneration with 0.5 M NaOH)

**System:** ÄKTA



**Fig 7.5.** Scaling up the purification of (His)<sub>6</sub>-mCherry-*Strep*-tag II, (A) StrepTrap HP 1 mL, (B) StrepTrap HP 5 mL, (C) StrepTactin Sepharose High Performance XK 26/20 with 5.5 mL bed height, 29 mL.

# Troubleshooting

Problem	Possible cause	Solution
Increased back pressure	High viscosity of solutions.	Use lower flow rates.  Increase dilution of the cell paste before mechanical lysis, or dilute after lysis to reduce viscosity.  If the lysate is very viscous due to a high concentration of host nucleic acid, continue sonication until the viscosity is reduced, and/or add additional DNase. Alternatively, draw the lysate through a syringe needle several times.  If the purification has been performed at 4°C, try repeating it at room temperature if possible (sample viscosity is reduced at room temperature).  Decrease flow rate during sample loading.
	Insufficient cell disruption.	Increase the efficiency of the mechanical cell disruption, e.g., increase sonication time. (Keep the sample on ice during sonication to avoid frothing and overheating as this may denature the target protein. Over-sonication can also lead to co-purification of host proteins with the target protein).
	Freezing/thawing of the unclarified lysate has increased precipitation and aggregation.	Centrifuge or pass through a 0.22 µm or 0.45 µm filter.
Column has clogged	Top filter is clogged.	Change top filter (does not apply to StrepTrap HP column). If using a StrepTrap HP column, replace the column. Also, optimize sample pretreatment before loading the next sample.
	Cell debris in the sample may clog the column.	Clean the column according to Appendix 4. Centrifuge and/or filter the sample through a 0.22 µm or a 0.45 µm filter or otherwise optimize sample pretreatment before loading the next sample.
No or weak binding to the column	Protein found in the flowthrough.	Buffer/sample composition is not optimal; check the pH and composition of the sample and binding buffer. pH should in general be pH 7 or higher.
	<i>Strep</i> -tag II is not present.	Use protease-deficient <i>E. coli</i> expression strains. Add protease inhibitors during cell lysis.
	<i>Strep</i> -tag II is not accessible.	Fuse <i>Strep</i> -tag II with the other protein terminus. Use another linker.
	The ligand is blocked by biotinylated proteins from the extract.	Add avidin (Biotin Blocking Buffer) if biotin- containing extracts are to be purified. The biotin content of the soluble part of the total <i>E. coli</i> cell lysate is about 1 nmol per liter of culture ( $A_{550} = 1.0$ ). Add 2 to 3 nmol of avidin monomer per nmol of biotin.
	Protein has precipitated in the column due to high protein concentration.	Clean the column according to instructions in Appendix 4. In the following run decrease the amount of sample, or decrease protein concentration by eluting with a linear gradient instead of step-wise elution. Try detergents or change the NaCl concentration.

continues on following page

Problem	Possible cause	Solution
Contaminating proteins	Contaminants are short forms of the tagged protein.	Use protease-deficient <i>E. coli</i> expression strains. Add protease inhibitors after cell lysis. Fuse <i>Strep</i> -tag II with the other protein terminus. Check for the presence of internal translation initiation starts (for C-terminal <i>Strep</i> -tag II) or premature termination sites (for N-terminal <i>Strep</i> -tag II). Use EDTA in the sample and buffers.
	Contaminants are covalently linked to the recombinant protein via disulfide bonds.	Add reducing agents to all buffers for cell lysis and purification.
	Contaminants are non-covalently linked to the recombinant protein.	Increase ionic strength in all buffers for cell lysis and purification (up to 1 M NaCl) or add mild detergents (0.1% Tween, 0.1% CHAPS). Modify pH to reduce potential electrostatic interactions.
Unwanted air bubble formation	Unclarified lysates may increase air bubble formation during purification.	Attaching a flow restrictor in the chromatography system can prevent this. If a flow restrictor is attached, it is important to change the pressure limit to adjust for the extra pressure from the flow restrictor. Do not exceed the pressure limit for the column on the ÄKTA system.  When using StrepTrap HP columns and ÄKTA system, it is important to change the pressure limit to 0.5 MPa (5 bar) on the ÄKTA system (the column and flow restrictor give a pressure of 0.3 MPa and 0.2 MPa, respectively).
	Air bubbles may form due to decreased air solubility when columns stored at 2°C to 8°C are used immediately at room temperature.	Let the columns adapt to room temperature for some minutes before using them.



08

# Purification of protein A-tagged proteins

Recombinant tagged proteins containing a protein A tag can be purified on IgG Sepharose 6 Fast Flow. The AC medium is based on the Sepharose 6 Fast Flow matrix, with human IgG covalently coupled to it. The mechanical characteristics of this Fast Flow medium allows high flow velocities (up to 400 cm/h) to be used for rapid and convenient single-step purification of protein A-tagged protein conjugates produced in prokaryotic expression systems. Up to 2 mg/mL protein A can be bound to the ligand at pH 7.5.

IgG Sepharose 6 Fast Flow is also suitable for tandem affinity purification (TAP) of protein complexes, see the Cytiva handbook *Purifying Challenging Proteins: Principles and Methods*, 28909531.

 An alternative eluent is 0.1 M glycine-HCl, pH 3.0. Chaotropic agents may also be used for elution.

Characteristics of IgG Sepharose 4 Fast Flow are shown in Table 8.1

**Table 8.1.** Characteristics of IgG Sepharose 6 Fast Flow

	Ligand	Composition	pH stability*	Particle size
IgG Sepharose 6 Fast Flow	Human polyclonal IgG	IgG coupled to Sepharose Fast Flow by the cyanogen bromide method.	Short term 3–10 Long term 3–10	90 μm

\* Short term refers to the pH interval for regeneration, cleaning in place and sanitization procedures. Long term refers to the pH interval over which the medium is stable over a long period of time without adverse effects on its subsequent chromatographic performance.

## Performing a separation using IgG Sepharose 6 Fast Flow


### Buffer preparation

Binding buffer:	0.05 M Tris-HCl, 0.15 M NaCl, 0.05% Tween 20, pH 7.6
Wash buffer:	5 mM ammonium acetate, pH 5.0
Elution buffer:	0.5 M acetic acid, adjusted to pH 3.4 with ammonium acetate
Neutralization buffer:	1 M Tris-HCl, pH 9.0

### Purification

1. Pack the column (see Appendix 3) and wash with at least 5 column volumes of binding buffer.
2. Equilibrate the column with approximately 5 column volumes of binding buffer.
3. Wash with 2–3 column volumes of acetic acid followed by 5 column volumes of binding buffer.
4. Apply the sample.
5. Wash with 10 column volumes binding buffer.
6. Wash with 2 column volumes of wash buffer or until no material appears in the eluent (determined by UV absorbance at  $A_{280\text{ nm}}$ ).
7. Elute with 2–5 column volumes of elution buffer.\*
8. Immediately re-equilibrate the column with binding buffer until the eluent reaches pH 7.0 (the IgG may denature if left at a lower pH).

\* Since elution conditions are quite harsh, it is recommended to collect fractions into neutralization buffer (60 μL – 200 μL 1 M Tris-HCl, pH 9.0 per mL fraction), so that the final pH of the fractions will be approximately neutral.

 This method, while giving a concentrated eluate, can only be used if the fusion product is stable under the acid conditions.

## Application example

Figure 8.1 shows automatic on-line monitoring of the production of a secreted fusion protein during fermentation. The fusion protein, ZZ-IGF-1 is insulin-like growth factor 1 fused with a derivative of protein A (designated ZZ), expressed in *E. coli*.

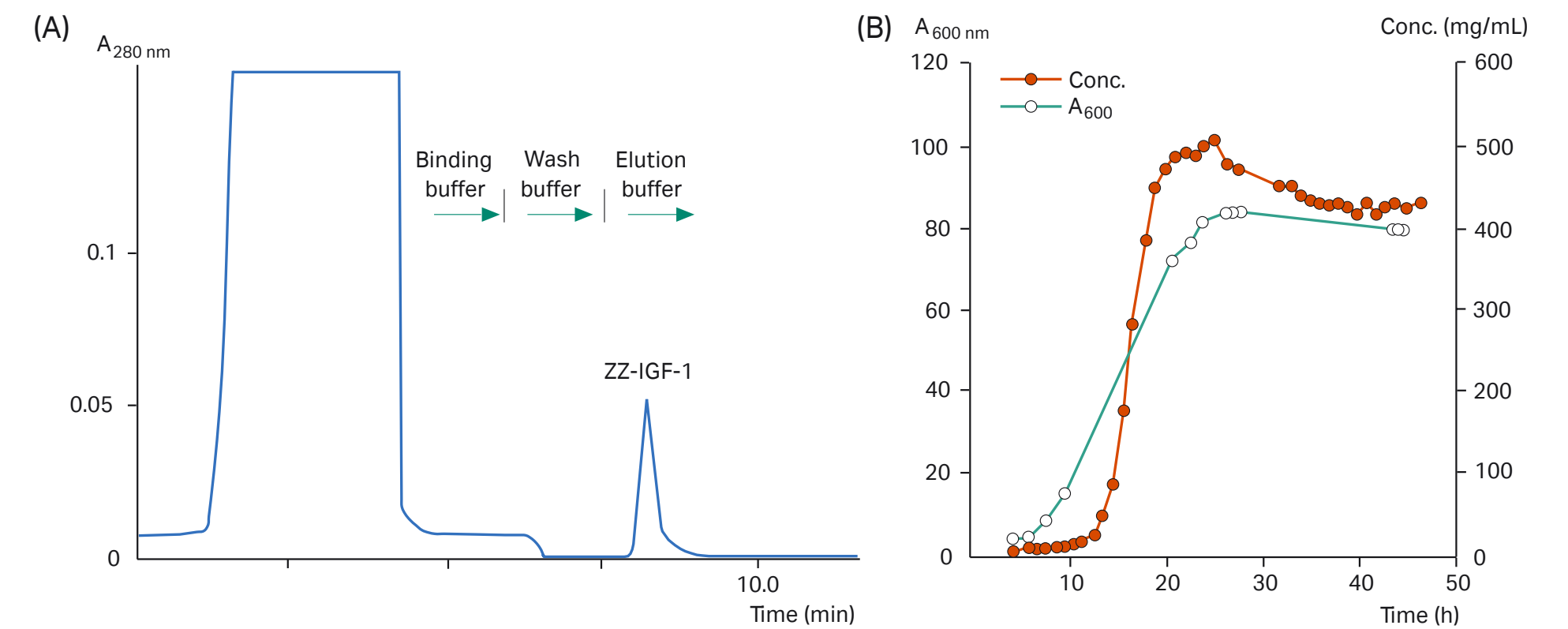
## Chemical stability

Avoid reducing agents such as 2-mercaptoethanol or DTT since they may disrupt disulfide bonds within the IgG ligand.

## Storage

Wash with 5 column volumes of 20% ethanol at neutral pH and store at +4°C to +8°C.

**Column:** IgG Sepharose 6 Fast Flow (0.5 × 2.5 cm)  
**Sample:** Bacterial suspension containing ZZ-IGF-1 fusion protein, automatically sampled from fermentation broth, 500 µL  
**Binding buffer:** 0.05 M Tris-HCl, 0.05% Tween 20, pH 7.6  
**Wash buffer:** 10 mM ammonium acetate, pH 4.6  
**Elution buffer:** 0.2 M acetic acid, pH 3.2



**Fig 8.1.** (A) Chromatogram of a sample taken at one time point during fermentation. (B) Results from automatic monitoring of the product concentration during fermentation. Concentration of ZZ-IGF-1 is determined by integration of the ZZ-IGF-1 peak obtained during each chromatographic analysis. Bacterial density is measured manually at  $A_{600 \text{ nm}}$ .



09

# Affinity chromatography in a purification strategy (CIPP)

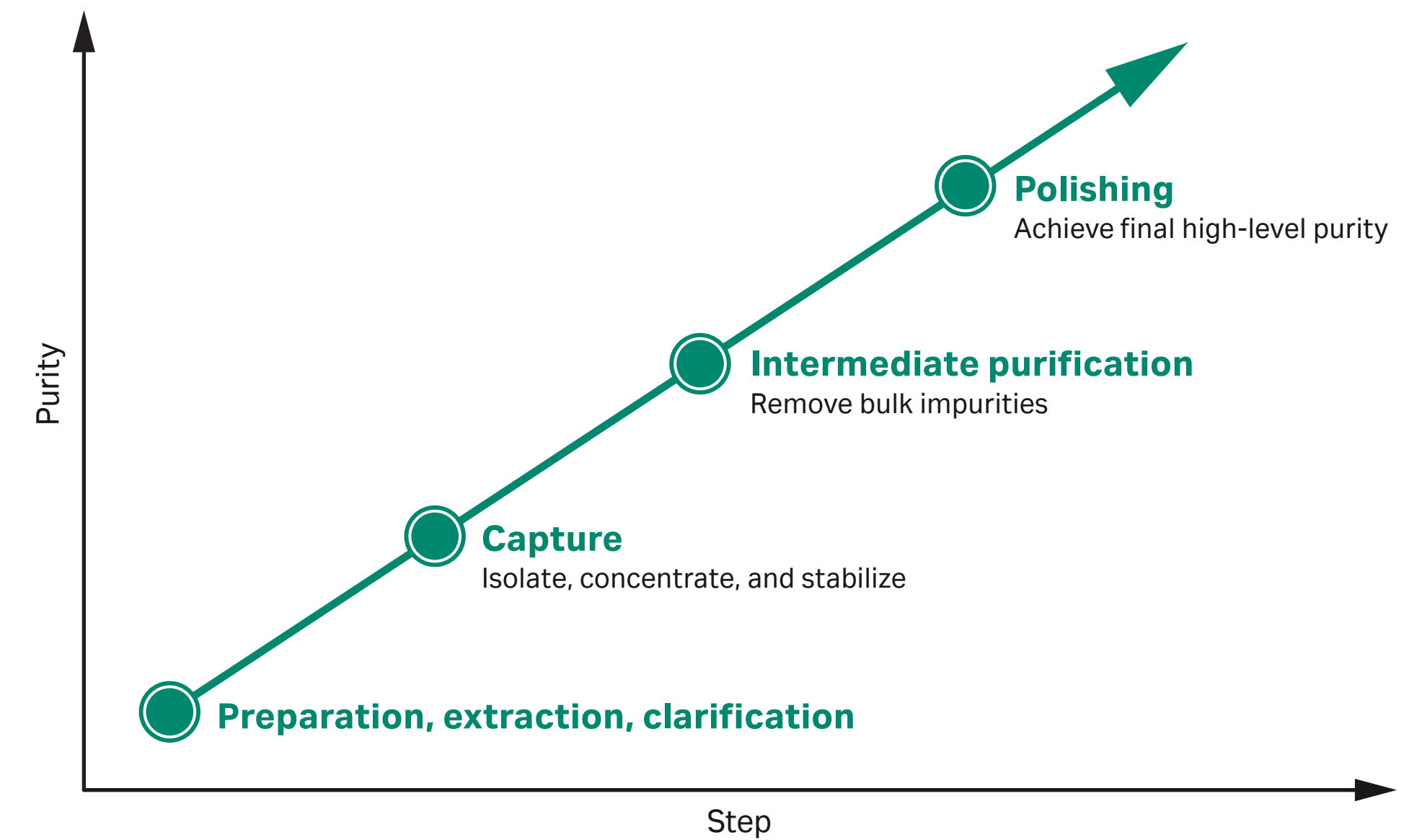
AC separates proteins on the basis of a reversible interaction between a protein (or group of proteins) and a specific ligand coupled to a chromatography matrix. With such high selectivity and hence high resolution for the protein(s) of interest, purification levels in the order of several thousand-fold with high recovery of active material are achievable. Samples are concentrated during binding and the target protein(s) is collected in a purified, concentrated form. AC can therefore offer immense time-saving over less selective multistep procedures.

In many cases, the high level of purity achieved in AC requires, at most, only a second step on a SEC column to remove unwanted small molecules, such as salts or aggregates.

For an even higher degree of purity, or when there is no suitable ligand for affinity purification, an efficient multistep process can be developed using the purification strategy of capture, intermediate purification, and polishing (CIPP), shown in Figure 9.1.

CIPP is used in both the pharmaceutical industry and in the research laboratory to ensure faster method development, a shorter time to pure product and good economy. AC can be used, in combination with other chromatography techniques, as an effective capture or intermediate step in a CIPP strategy.


This chapter gives a brief overview of the approach recommended for any multistep protein purification. *The Strategies for Protein Purification Handbook*, 28983331 from Cytiva is highly recommended as a guide to planning efficient and effective protein purification strategies and for the selection of the correct medium for each step and scale of purification.



**Fig 9.1.** Preparation and CIPP.

## Applying CIPP

Imagine the purification has three phases: Capture, Intermediate Purification, and Polishing.


 Assign a specific objective to each step within the purification process.


The issues associated with a particular purification step will depend greatly upon the properties of the starting material. Thus, the objective of a purification step will vary according to its position in the process.

In the *capture phase*, the objectives are to *isolate, concentrate, and stabilize* the target product. The product should be concentrated and transferred to an environment that will conserve potency/activity.

During the *intermediate purification phase*, the objectives are to *remove most of the bulk impurities*, such as other proteins and nucleic acids, endotoxins, and viruses.

In the *polishing phase*, most impurities have already been removed. The objective is to *achieve final purity* by removing any remaining trace impurities or closely related substances.

 The optimal selection and combination of purification techniques for *Capture, Intermediate Purification, and Polishing* is crucial for an efficient purification.

 CIPP does not mean that there must always be three purification steps. For example, capture and intermediate purification might be achievable in a single step, as might intermediate purification and polishing. Similarly, purity demands can be so low that a rapid capture step is sufficient to achieve the desired result. For purification of therapeutic proteins, a fourth or fifth purification step might be required to fulfill the highest purity and safety demands. The number of steps used will always depend upon the purity requirements and intended use of the protein.

## Selection and combination of purification techniques

Proteins are purified using purification techniques that separate according to differences in specific properties, as shown in Table 9.1.

**Table 9.1.** Protein properties used during purification

Protein property	Chromatography technique
Size	Size exclusion chromatography (SEC)
Charge	Ion exchange chromatography (IEX)
Hydrophobicity	Hydrophobic interaction chromatography (HIC) Reversed phase chromatography (RPC)
Biorecognition (ligand specificity)	Affinity chromatography (AC)

There are four important performance parameters to consider when planning each purification step: resolution, capacity, speed, and recovery. Optimization of any one of these four parameters can be achieved only at the expense of the others, and each purification step will be a compromise (Fig 9.2). The importance of each parameter will vary depending on whether a purification step is used for capture, intermediate purification, or polishing. Purification methods should be selected and optimized to meet the objectives for each purification step.



**Capacity**, in the simple model shown, refers to the amount of target protein loaded during purification. In some cases the amount of sample that can be loaded will be limited by volume (as in SEC) or by large amounts of contaminants rather than the amount of the target protein.

**Speed** is most important at the beginning of purification where contaminant such as proteases must be removed as quickly as possible.

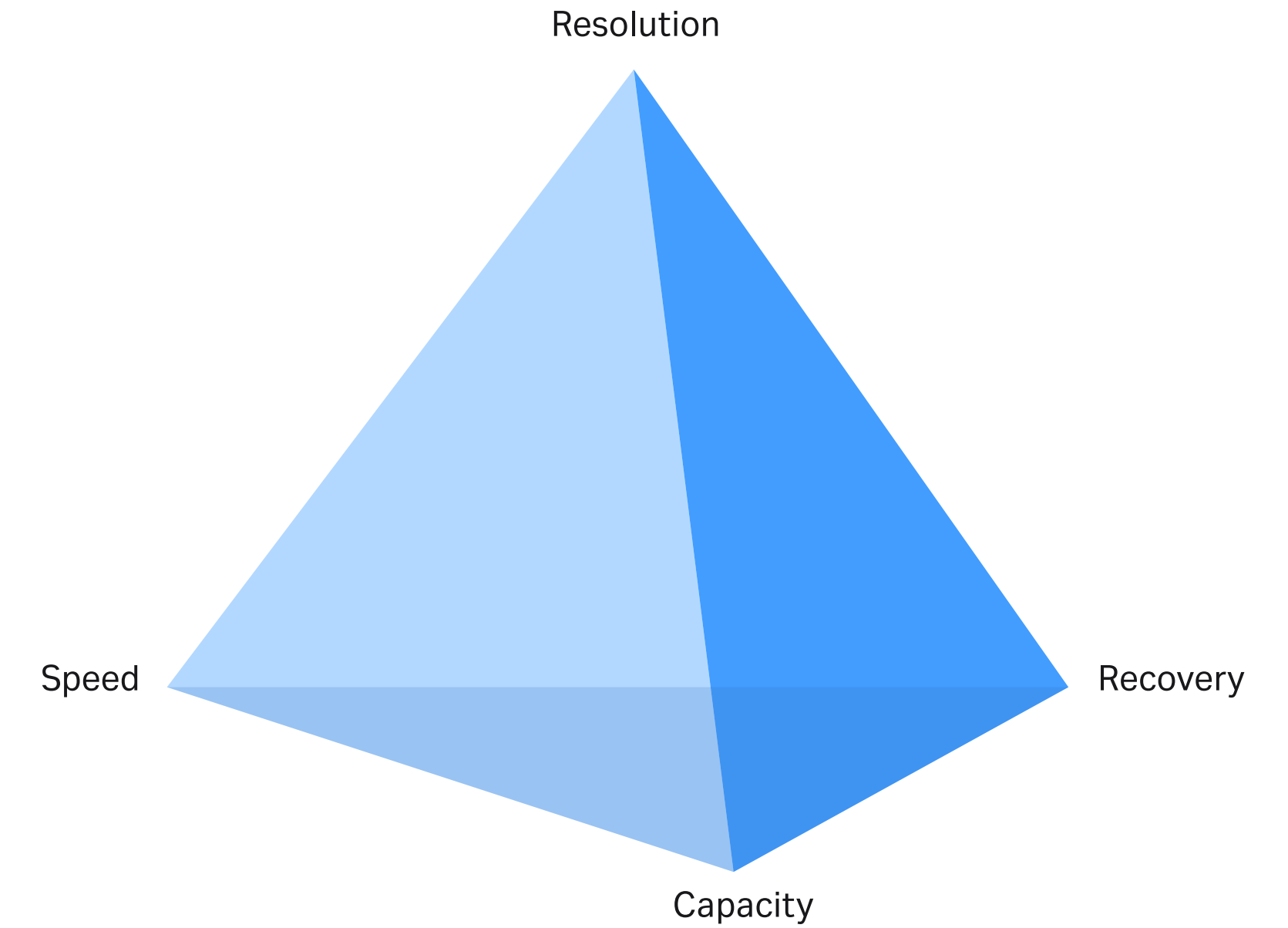
**Recovery** becomes increasingly important as the purification proceeds because of the increased value of the purified product. Recovery is influenced by destructive processes in the sample and by unfavorable conditions on the column.

**Resolution** is achieved by the selectivity of the technique and the efficiency and selectivity of the chromatography matrix in producing narrow peaks. In general, resolution is most difficult to achieve in the final stages of purification when impurities and target protein are likely to have very similar properties.

☞ Select a technique to meet the objectives for the purification step.

☞ Choose logical combinations of purification techniques based on the main benefits of the technique and the condition of the sample at the beginning or end of each step.


A guide to the suitability of each purification technique for the stages in CIPP is shown in Table 9.2.





**Fig 9.2.** Key performance parameters for protein purification. Each purification step should be optimized for one or two of the parameters.

**Table 9.2.** Suitability of purification techniques for CIPP

Method	Typical characteristics		Purification phase			Sample start conditions	Sample end conditions
	Resolution	Capacity	Capture	Intermediate	Polishing		
AC	+++ or ++	+++ or ++	+++	++	+	Various binding conditions	Specific elution conditions
SEC	++	+	+		+++	Most conditions acceptable, limited sample volume	Buffer exchange possible, diluted sample
IEX	+++	+++	+++	+++	+++	Low ionic strength, pH depends on protein and IEX type	High ionic strength or pH changed
HIC	+++	++	++	+++	+++	High ionic strength, addition of salt required	Low ionic strength
RPC	+++	++		+	++	Ion-pair reagents and organic modifiers might be required	Organic solvents (risk for loss of biological activity)

 Minimize sample handling between purification steps by combining techniques to avoid the need for sample conditioning. The product should be eluted from the first column in conditions suitable for the start conditions of the next column (see Table 9.2).

 Ammonium sulfate, often used for sample clarification and concentration (see Appendix 1), leaves the sample in a high salt environment. Consequently HIC, which requires high salt to enhance binding to the chromatography media, becomes the excellent choice as the capture step. The salt concentration and the total sample volume will be significantly reduced after elution from the HIC column. Dilution of the fractionated sample or rapid buffer exchange using a desalting column will prepare it for the next IEX or AC step.

 SEC is a nonbinding technique unaffected by buffer conditions, but with limited volume capacity. SEC is well-suited for use after any of the concentrating techniques (IEX, HIC, AC) since the target protein will be eluted in a reduced volume and the components from the buffer will not affect the size exclusion process.

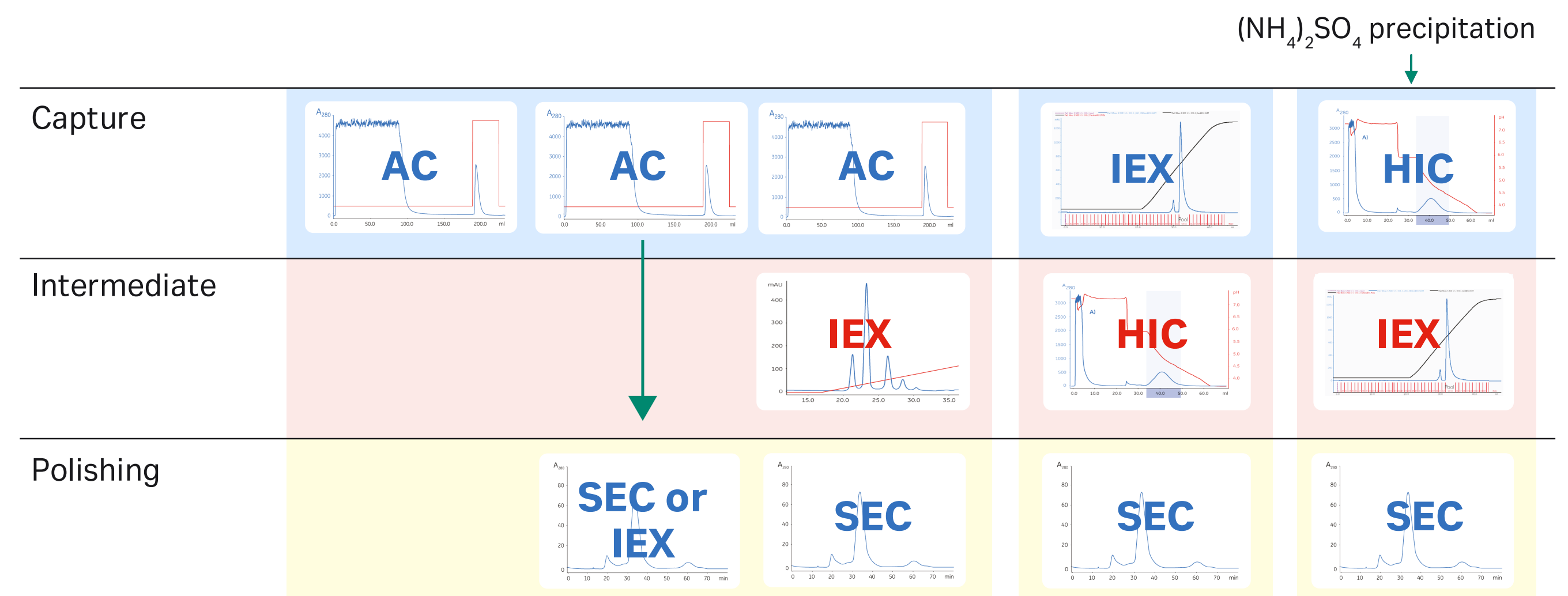
Selection of the final strategy will always depend upon specific sample properties and the required level of purification. Logical combinations of techniques are shown in Figure 9.3.

☞ For any capture step, select the technique showing the most effective binding to the target protein while binding as few of the contaminants as possible, that is, the technique with the highest selectivity and/or capacity for the target protein.

A sample is purified using a combination of techniques and alternative selectivities. For example, in an IEX-HIC-SEC strategy, the capture step selects according to differences in charge (IEX), the intermediate purification step according to differences in hydrophobicity (HIC), and the final polishing step according to differences in size (SEC).

☞ If nothing is known about the target protein, use IEX-HIC-SEC. This combination of techniques can be regarded as a standard protocol.

☞ Consider the use of both AIEX and CIEX to give different selectivities within the same purification strategy.



**Fig 9.3.** Examples of logical combinations of chromatography steps.



**10**

# **Handling inclusion bodies**

Recombinant proteins are most often expressed in the intracellular space, but expression can also be controlled so that the protein is secreted into the periplasmic space or out into the culture medium. While secretion is advantageous in terms of protein folding, solubility, and disulfide bonding, the yield is generally much higher when using intracellular expression.

However, recombinant protein accumulated intracellularly is frequently deposited in the form of inclusion bodies, insoluble aggregates of misfolded protein lacking biological activity. The recombinant protein is often the major component of the inclusion bodies. The preparation of inclusion bodies can therefore be a purification step of significant importance. The isolation of proteins from inclusion bodies, though, often leads to difficulties with refolding and usually does not give full recovery of biological activity. Table 10.1 summarizes the advantages and disadvantages of working with recombinant products expressed as inclusion bodies. Inclusion body formation frequently occurs when eukaryotic proteins are expressed in bacterial hosts.

**Table 10.1.** Advantages and disadvantages of inclusion bodies

<b>Advantages</b>	<b>Disadvantages</b>
High expression levels	Refolding is often cumbersome and optimal conditions cannot be predicted
Inclusion bodies can be isolated to high purity	
Inclusion bodies can offer protection from proteolytic enzymes	
Allows expression of toxic proteins	

If the protein is expressed as inclusion bodies, there are several options to consider: optimize as much as possible for soluble expression, accept the formation of inclusion bodies but develop strategies to solubilize and refold the protein, try another expression host, or modify the plasmid construct. Expression as inclusion bodies can allow expression of proteins that are toxic to the host cell. Refer to *Purifying Challenging Proteins: Principles and Methods*, 28909531 for further information on handling, isolating, and refolding inclusion bodies.

## Optimizing for soluble expression

The reasons for inclusion body formation are not well understood. However, it is well known that a reduced growth rate usually leads to more soluble expression and hence reduces the tendency to form inclusion bodies.

A few straightforward modifications to culture conditions, aimed at reducing the growth rate and/or the rate of expression, are thus worthwhile to consider for optimizing soluble expression. A drawback is that the overall yield of recombinant protein is also likely to decrease as a result.

A reduced growth rate can be achieved by lowering the growth temperature to between 20°C and 30°C.

For proteins that are expressed under the control of an inducible promoter, the rate of expression can also be reduced by altering the induction conditions:

- induce at lower cell densities ( $A_{600} = 0.5$ )
- induce for a shorter period of time
- induce using a lower concentration of the inducing agent (e.g., 0.1 mM IPTG)

Should these modifications prove insufficient, more comprehensive changes can be considered. These include the use of fusion tags, such as GST and maltose binding protein (MBP), which have been reported to enhance solubility (Reference: Esposito, D. and Chatterjee, D. K. Enhancement of soluble protein expression through the use of fusion tags. *Current Opinion Biotech*, **17**, 353–358 (2006). Other options include coexpression with chaperonins or other folding-machinery components, and the use of an alternative host organism. A comprehensive description of procedures that increase soluble expression is outside the scope of this handbook.

## Solubilizing inclusion bodies


If culture modifications do not significantly improve the yield of soluble tagged proteins, then common denaturants such as 4 to 6 M Gua-HCl, 4 to 8 M urea, detergents, alkaline pH (> 9), organic solvents, or N-laurylsarcosine can be used to solubilize inclusion bodies.

Success of affinity purification in the presence of denaturing agents will depend on the nature of the tagged protein. It is important to test the chosen denaturant with the target protein before introducing it into the solubilization strategy.

For each denaturant the success of solubilization will be affected by the presence and concentration of reducing agent, time, temperature, ionic strength, and the ratio of denaturant to protein. Refer to Table 10.2 for experimental starting points for solubilization of inclusion bodies. Solubilized proteins can often be purified at this stage by using a separation technique that is compatible with the presence of the denaturant. Purification and refolding can often be combined in the same purification step, for example, by chromatographic on-column refolding.

**Table 10.2.** Experimental starting points for solubilization of inclusion bodies


	<b>Buffer</b>	<b>Denaturant</b>	<b>Inclusion body conc. (mg/mL, wet weight)</b>	<b>Temp (°C)</b>	<b>Time</b>	<b>Reducing agent</b>
Start condition	50 mM Tris-HCl, pH 8.0	8 M urea	10–20	Ambient	60 min	–
Variation range	(Not critical)	6–8 M urea 6–8 M Gua-HCl		4–95	15 min–12 h	1–10 mM DTT or TCEP (if the protein contains disulfide bonds)

 Many alternative solubilization protocols have been published (e.g., REFOLD database). Options include the use of SDS (10%), N-laurylsarcosine, or other detergents and extremes of pH.



## Refolding of solubilized recombinant proteins

Following solubilization, proteins must be properly refolded to regain function. Denaturing agents must always be removed to allow refolding of the protein and formation of the correct intramolecular associations. Critical parameters during refolding include pH, presence of reducing reagents (often a mixture of reduced and oxidized forms of a weak reducing agent, e.g., glutathione, is used), the speed of denaturant removal, and the purity of the protein to be refolded. Table 10.3 compares conventional methods for refolding with on-column affinity purification and refolding.

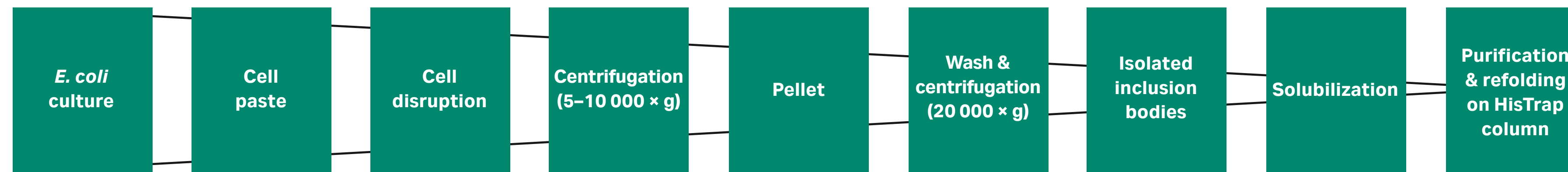
 Refolding usually requires extensive optimization. One should always consider other alternatives (as mentioned earlier), for example, optimizing expression parameters, making a new construct, or changing the expression host.

### On-column refolding

Using a histidine-tagged protein enables the use of a simple, but efficient, purification and on-column refolding procedure that produces soluble protein exhibiting the desired biological activity. The protocol shown in Figure 10.1 has been used successfully for several different histidine-tagged proteins.

The strong binding of histidine-tagged proteins to immobilized divalent metal ions is not disrupted by high concentrations of chaotropic agents (such as urea or Gua-HCl). Consequently, (histidine)<sub>6</sub>-tagged proteins can be solubilized by chaotropic extraction and bound to Ni Sepharose. Removal of contaminating proteins and refolding by exchange to nondenaturing buffer conditions can be performed before elution of the protein from the column.

Once refolded, the protein may be purified further by any other chromatography technique as for any native protein (see Chapter 8) if a higher degree of purity is required.



**Fig 10.1.** General scheme for the extraction, solubilization, and refolding of (histidine)<sub>6</sub>-tagged proteins produced as inclusion bodies in *E. coli* cells.

**Table 10.3.** Comparison of methods for protein refolding

Refolding techniques	Advantages/Disadvantages
Dialysis	Takes several days. Uses large volumes of buffer.
Dilution	Simple technique. May require very slow dilution by adding sample drop-by-drop. Gives extensive dilution, often several hundred-fold.
SEC	Separation of aggregated material from native protein. Aggregates formed on the column may be difficult to remove. High protein concentrations can often be used. Only small volumes can be processed per column. Slow.
On-column refolding	Fast and simple. No sample volume limitations. High sample concentrations can be used. Refolded material can be obtained at high concentration after elution. Success varies and is dependent on the protein.

## Analysis of correctly folded proteins


Table 10.4 summarizes various techniques used to assess whether proteins are correctly folded.

**Table 10.4.** Analysis of correctly folded proteins


Protein properties	Techniques
Protein function	Enzyme activity assay Binding activity
Size and molecular weight	SEC SEC with MALLS (Multi-Angle Laser Light Scattering) Native PAGE MS
S-S-bridges	Reversed phase chromatography MS
Tertiary structure	Intrinsic fluorescence NMR
Secondary structure	Circular dichroism Chromatographic behavior (e.g., HIC, RPC, or IEX)
Compactness of native state	Limited proteolysis combined with SDS-PAGE

## Application


### Purification and on-column refolding of an insoluble histidine-tagged protein from a 100 mL *E. coli* culture using HisTrap FF 1 mL with ÄKTAprime plus

 This procedure uses a HisTrap FF 1 mL column but also can be used with a HisTrap HP 1 mL or a HisTrap FF crude 1 mL column.

### Preparing the buffers


 Use high-purity water and chemicals, and pass all buffers through a 0.45 µm filter before use.

Resuspension buffer: 20 mM Tris-HCl, pH 8.0  
Isolation buffer: 2 M urea, 20 mM Tris-HCl, 0.5 M NaCl, 2% Tween-20, pH 8.0  
Binding buffer (port A1): 6 M Gua-HCl, 20 mM Tris-HCl, 0.5 M NaCl, 5 mM imidazole, 1 mM β-mercaptoethanol, pH 8.0  
Solubilization buffer: 6 M urea, 20 mM Tris-HCl, 0.5 M NaCl, (port A2) 5 mM imidazole, 1 mM β-mercaptoethanol, pH 8.0  
Elution buffer (port A3): 20 mM Tris-HCl, 0.5 M NaCl, 0.5 M imidazole, 1 mM β-mercaptoethanol, pH 8.0  
Refolding buffer (port B): 20 mM Tris-HCl, 0.5 M NaCl, 5 mM imidazole, 1 mM β-mercaptoethanol, pH 8.0  
Prepare at least 500 mL of each eluent.

 Alternative binding buffers: 5 to 40 mM imidazole can be included in the binding buffer to reduce nonspecific binding of non-histidine-tagged proteins. The concentration of imidazole is protein dependent, and if the protein of interest elutes or does not bind at a certain imidazole concentration, reduce the concentration.


## Disruption, wash, and isolation of inclusion bodies


1. Resuspend the cell paste from 100 mL culture in 4 mL resuspension buffer.
2. Disrupt cells with sonication on ice (e.g., 4 × 10 s).
3. Centrifuge at high speed for 10 min at 4°C.
4. Remove supernatant and resuspend pellet in 3 mL of cold isolation buffer. Sonicate as above.
5. Centrifuge at high speed for 10 min at 4°C.
6. Repeat steps 4 and 5.

 At this stage the pellet material can be washed once in buffer lacking urea and stored frozen for later processing.

## Solubilization and sample preparation


1. Resuspend pellet in 5 mL of binding buffer.
2. Stir for 30 to 60 min at room temperature.
3. Centrifuge for 15 min at high speed, 4°C.
4. Remove any remaining particles by passing sample through a 0.45 µm filter.

 The optimal concentration of β-mercaptoethanol (0 to 20 mM) must be determined experimentally for each individual protein.

 If it has not been prepared as above, adjust the sample to the composition of binding buffer by diluting in binding buffer or by buffer exchange using a desalting column (see Chapter 11), then pass the sample through a 0.45 µm filter.

## Preparing the system

 If a linear gradient formation for refolding and elution is chosen, the use of a chromatography system is essential.

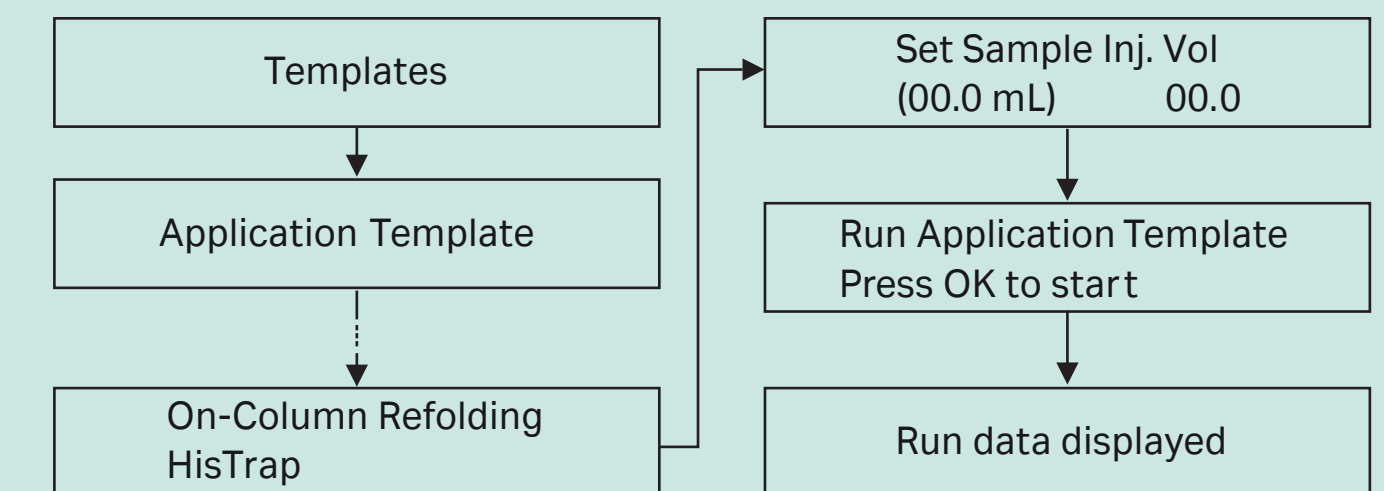
 This example uses ÄKTAprime plus. Once the system is prepared, the remaining steps (under *Selecting Application Template and starting the method*) will be performed automatically.

1. Place each inlet tubing from port A (8-port valve) in eluents as given above and the tubing from port B (2-port valve) in the elution buffer.
2. Place the three brown waste tubings in waste.
3. Connect the column between port 1 on the injection valve (7-port valve) and the UV flow cell.
4. Fill the fraction collector rack with 18 mm tubes (minimum 40) and position the white plate on the fractionation arm against the first tube.
5. Connect a sample loop large enough for your sample between port 2 and 6 on the injection valve. Use a syringe to manually fill the loop.

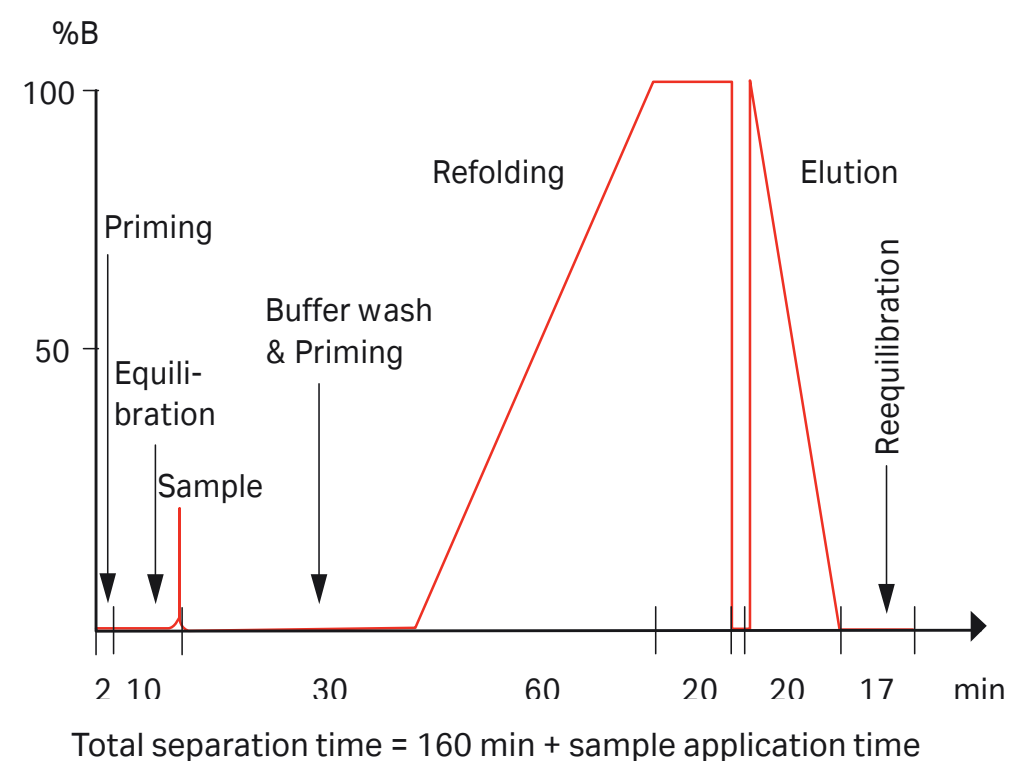
*Note: If a Superloop™ is needed, additional information is supplied in the instructions for Superloop.*

## Selecting Application Template and starting the method

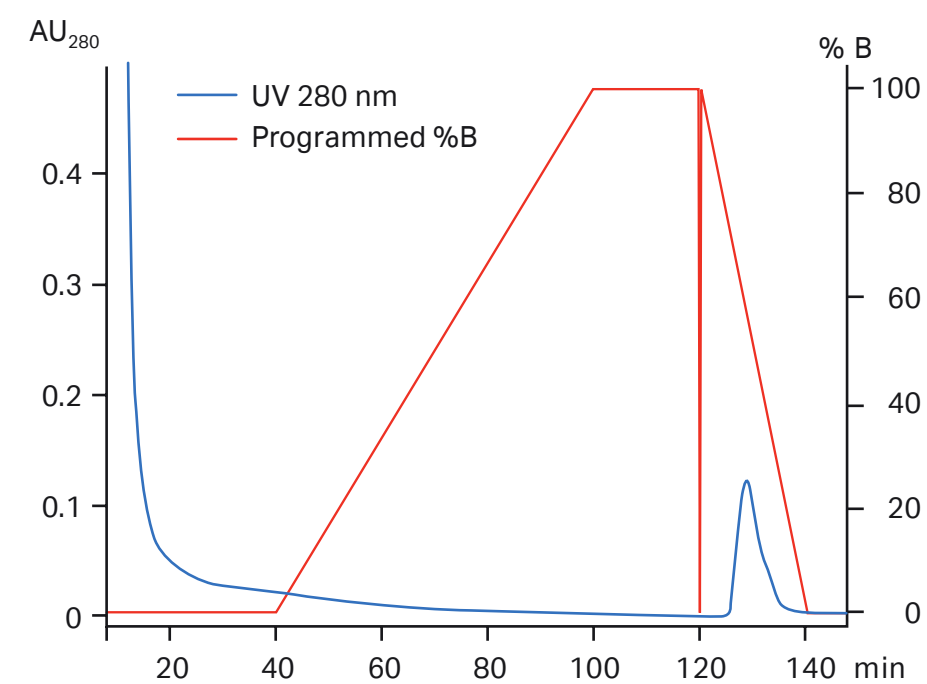
1. Check the communication to PrimeView. At the lower right corner of the screen the text **Controlled By: prime** should be displayed.
2. Use the arrow and OK buttons to move in the menu tree until you find **On-Column Refolding HisTrap**.
3. Enter the sample volume and press **OK** to start the template.







**Fig 10.2.** Theoretical gradient in on-column refolding HisTrap Application Template.



**Fig 10.3.** On-column refolding of a histidine-tagged protein.

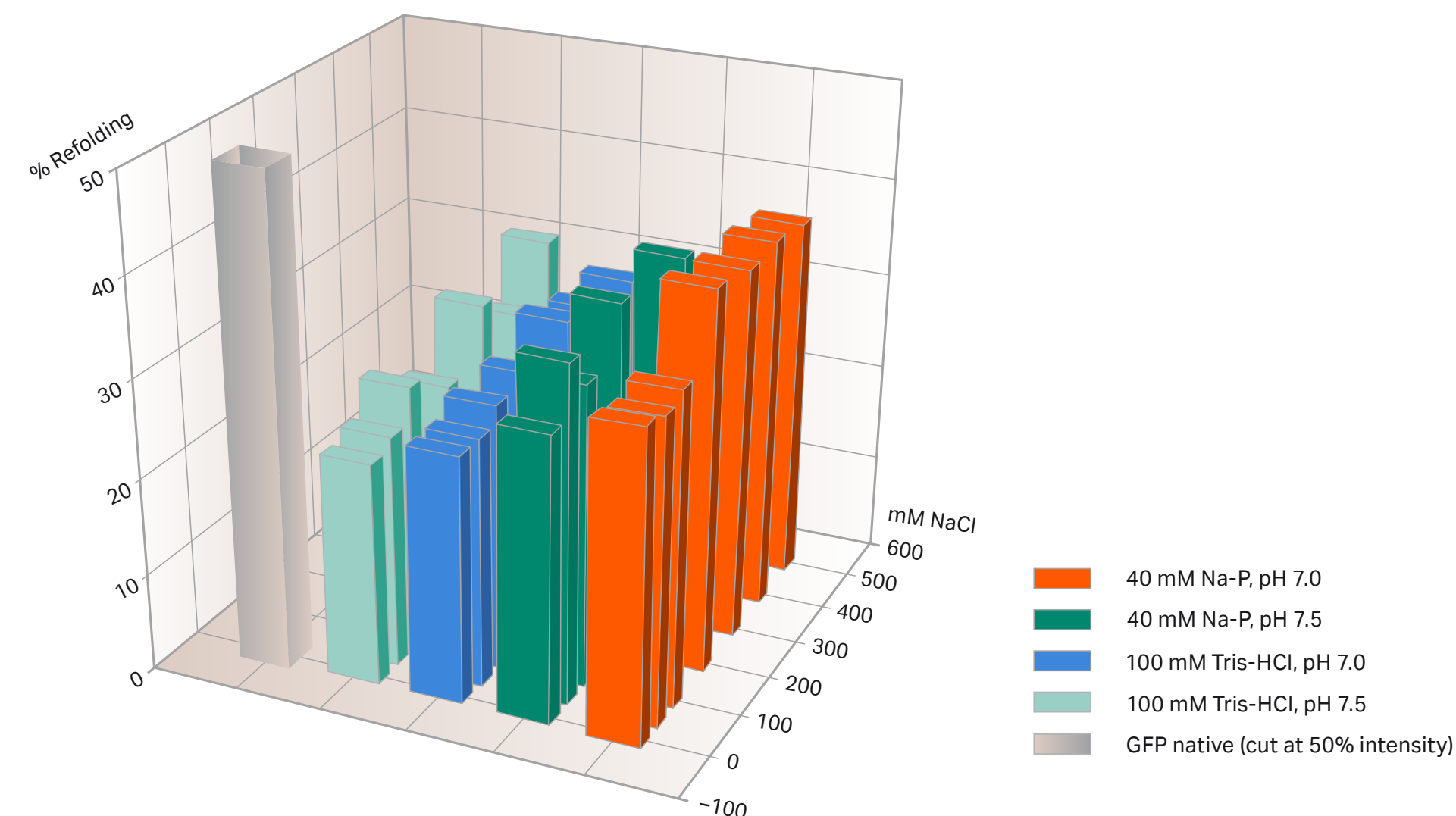
**Sample:** Clarified homogenate of *E. coli* expressing histidine-tagged protein  
**Column:** HisTrap FF 1 mL  
**Binding buffer (A1):** 6 M Gua-HCl, 20 mM Tris-HCl, 0.5 M NaCl, 5 mM imidazole, 1mM  $\beta$ -mercaptoethanol, pH 8.0  
**Solubilization buffer (port A2):** 6 M urea, 20 mM Tris-HCl, 0.5 M NaCl, 5 mM imidazole, 1mM  $\beta$ -mercaptoethanol, pH 8.0  
**Elution buffer (port A3):** 20 mM Tris-HCl, 0.5 M NaCl, 0.5 M imidazole, 1 mM  $\beta$ -mercaptoethanol, pH 8.0  
**Refolding buffer (port B):** 20 mM Tris-HCl, 0.5 M NaCl, 5 mM imidazole, 1 mM  $\beta$ -mercaptoethanol, pH 8.0

## Screening conditions for refolding using IMAC

MultiTrap 96-well plates are useful products for screening of IMAC refolding conditions (Table 10.5). In this example, solubilized, unfolded protein was dispensed in His MultiTrap FF wells. The proteins were incubated in various refolding buffers, and the extent of refolding was determined (Fig 10.4). Optimal buffers from similar screening experiments can be used for scale-up on-column refolding on HisTrap FF.

**Table 10.5.** Useful products for screening IMAC refolding conditions

Product	Description
His MultiTrap FF	96-well plate; 800 $\mu$ L wells filled with 50 $\mu$ L Ni Sepharose 6 Fast Flow
His MultiTrap HP	96-well plate; 800 $\mu$ L wells filled with 50 $\mu$ L Ni Sepharose High Performance






**Fig. 10.4.** Screening of IMAC refolding conditions for histidine-tagged GFP using His MultiTrap FF. This initial screen covered buffer substances, pH and salt concentrations. Data kindly provided by J. Buchner, M. Haslbeck and T. Dashivets, Munich Technical University, Germany.

11


# Desalting/buffer exchange and concentration

Desalting at laboratory scale is a well-proven, simple, and very fast method that will rapidly remove low molecular weight contaminants at the same time as transferring the sample into the desired buffer in a single step.

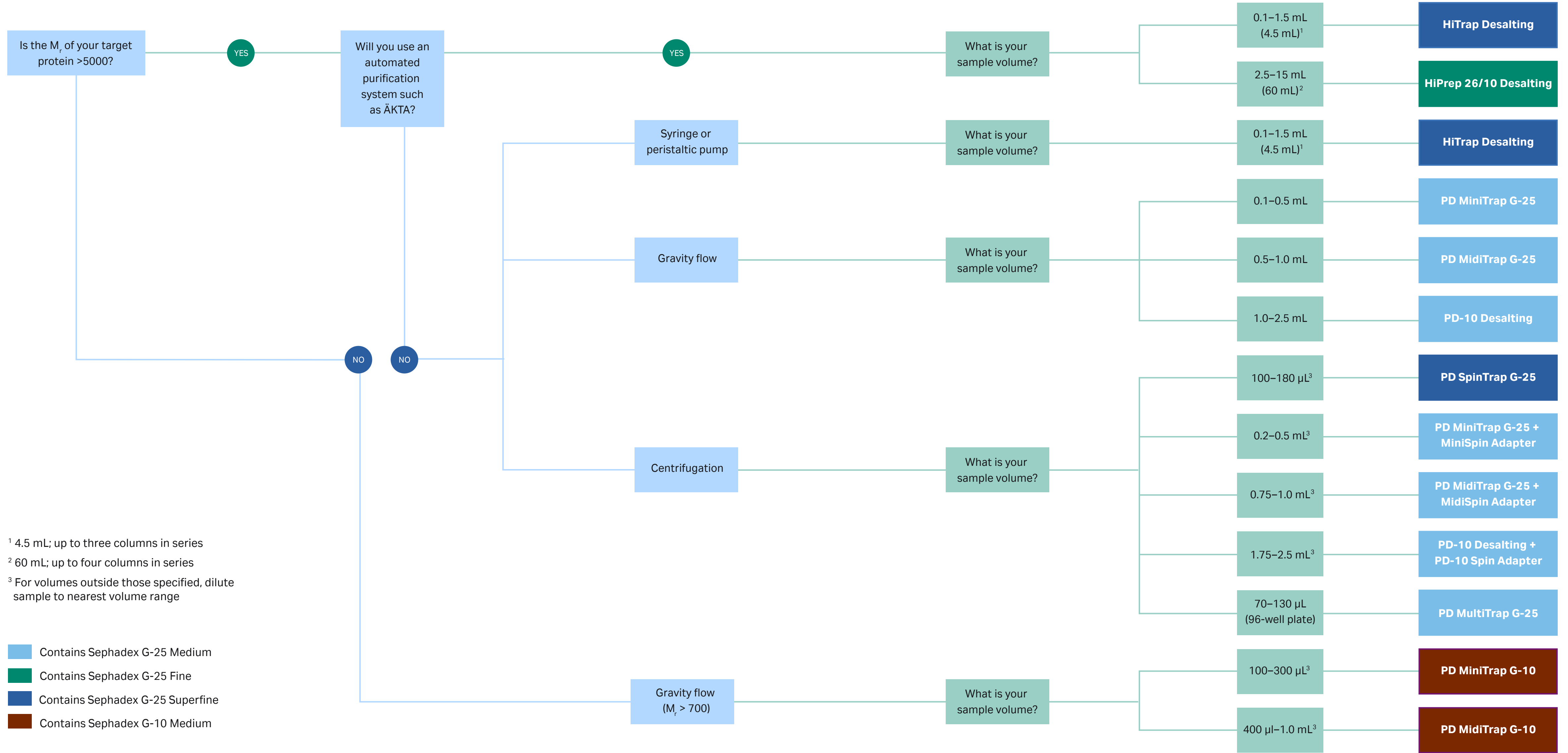
Cytiva offers a range of prepacked chromatography columns and 96-well filter plates that can be used manually, together with a chromatography system, or in high-throughput applications (Table 11.1). The majority of these products contain Sephadex G-25, an SEC medium that allows effective removal of low molecular weight substances from proteins with  $M_r > 5000$ . PD MiniTrap™ G-10 and PD MidiTrap™ G-10 columns contain Sephadex G-10. These prepacked, single-use gravity columns allow desalting/buffer exchange of smaller proteins with  $M_r > 700$ .

-  Use desalting/buffer exchange when needed, before purification, between purification steps, and/or after purification. These are very fast methods compared with dialysis, but remember that each extra step can reduce yield and that desalting dilutes the sample (centrifugation protocols do not dilute samples).
-  Use Sephadex G-25 products to remove salts and other low molecular weight compounds from proteins with  $M_r > 5000$  and Sephadex G-10 products for proteins (peptides) with  $M_r > 700$ .
-  Occasionally, purified fractions may have a concentration of target protein that is too low, and sample concentration is needed. Vivaspin sample concentrators, which perform gentle, nondenaturing membrane ultrafiltration, are suitable for this purpose. See later in this chapter for a discussion of Vivaspin products.

Desalting provides several advantages over dialysis. Dialysis is generally a slow technique that requires large volumes of buffer and carries the risk that material and target protein activity will be lost during handling. When desalting, sample volumes of up to 30% of the total volume of the desalting column can be processed. The high speed and capacity of the separation allows even relatively large sample volumes to be processed rapidly and efficiently in the laboratory. Sample concentration does not influence the separation as long as the concentration of proteins does not exceed approximately 70 mg/mL when using normal aqueous buffers, and provided that the target protein is stable and soluble at the concentration used. Use 100 mM ammonium acetate or 100 mM ammonium hydrogen carbonate if volatile buffers are required.

-  Consider whether the conditions of the sample can be adjusted simply by additions or dilution of the sample. For affinity chromatography (AC) or ion exchange chromatography (IEX), it may be sufficient to adjust the pH of the sample and, if necessary, the ionic strength of the sample. Before hydrophobic interaction chromatography (HIC) ammonium sulfate is normally added and the pH is adjusted.





**Fig 11.1.** Selection guide: Prepacked columns for desalting/buffer exchange.

**Table 11.1.** Selection table for desalting/buffer exchange columns

Columns and 96-well plates	Chromatography medium	Loaded volume (mL)*	Eluted volume (mL)	Dilution factor	Operation
PD SpinTrap G-25	Sephadex G-25 Superfine	0.10–0.18	0.10–0.18	No dilution	Centrifuge
PD MultiTrap G-25	Sephadex G-25 Medium	0.07–0.13 <sup>†</sup>	0.07–0.13	No dilution	Centrifuge
PD MiniTrap G-25	Sephadex G-25 Medium	0.1–0.5	0.1–0.5	No dilution	Centrifuge
		0.1–0.5	1.0	2–10	Gravity flow
PD MidiTrap G-25	Sephadex G-25 Medium	0.75–1.0	0.5–1.0	No dilution	Centrifuge
		0.5–1.0	1.5	1.5–3	Gravity flow
PD-10 Desalting columns	Sephadex G-25 Medium	1.75–2.5	1.0–2.5	No dilution	Centrifuge
		1.0–2.5	3.5	1.5–3.5	Gravity flow
PD MiniTrap G-10	Sephadex G-10 Medium	0.1–0.3	0.5	1.7–5	Gravity flow
PD MidiTrap G-10	Sephadex G-10 Medium	0.4–1.0	1.2	1.2–3	Gravity flow
HiTrap Desalting	Sephadex G-25 Superfine	0.25	1.0	4 (approx)	Syringe/pump/system
		0.5	1.5	3 (approx)	Syringe/pump/system
		1.0	2.0	2 (approx)	Syringe/pump/system
		1.5 (max.)	2.0	1.3 (approx)	Syringe/pump/system
2× HiTrap Desalting	Sephadex G-25 Superfine	3.0 (max.)	4.0–5.0	1.3–1.7	Syringe/pump/system
3× HiTrap Desalting	Sephadex G-25 Superfine	4.5 (max.)	6.0–7.0	1.3–1.7	Syringe/pump/system
HiPrep 26/10	Sephadex G-25 Fine	10	10–15	1.0–1.5	Pump/system
		15 (max.)	15–20	1.0–1.3	Pump/system
2× HiPrep 26/10	Sephadex G-25 Fine	30 (max.)	30–40	1.0–1.3	Pump/system
3× HiPrep 26/10	Sephadex G-25 Fine	45 (max.)	45–55	1.0–1.2	Pump/system
4× HiPrep 26/10	Sephadex G-25 Fine	60 (max.)	60–70	1.0–1.2	Pump/system

- Contains Sephadex G-25 Medium
- Contains Sephadex G-10 Medium
- Contains Sephadex G-25 Superfine
- Contains Sephadex G-25 Fine

\* For sample volumes less than 0.14 mL is recommended to apply a stacker volume of equilibration buffer to reach a total of 0.14 mL after the sample has fully absorbed.

† For sample volumes less than 0.10 mL it is recommended to apply a stacker volume of equilibration buffer to reach a total of 0.10 mL after the sample has fully absorbed.



## General considerations

### Small-scale desalting of samples

For sample volumes ranging from 0.1 to 2.5 mL, it is possible to run multiple samples in parallel with PD-10 Desalting, PD MidiTrap G-25, and PD MiniTrap G-25 columns. Two different protocols are available for these columns: one for manual use on the laboratory bench and one for use together with a standard centrifuge in combination with a Spin Adapter. For smaller proteins (peptides) ( $M_r > 700$ ), PD MiniTrap G-10 and PD MidiTrap G-10 columns may be used.

For smaller sample volumes, multiple samples can be run on PD SpinTrap G-25 spin columns together with a microcentrifuge or PD MultiTrap G-25 96-well plate using centrifugation for extraction (Fig 11.2 A-D). Although possible to perform, using PD MultiTrap G-25 with vacuum is not recommended.

### Desalting larger sample volumes using HiTrap and HiPrep columns

Connect up to three HiTrap Desalting columns in series to increase the sample volume capacity. For example, two columns allow a sample volume of 3 mL, and three columns allow a sample volume of 4.5 mL (Table 11.1).

Connect up to four HiPrep 26/10 Desalting columns in series to increase the sample volume capacity. For example, two columns allow a sample volume of 30 mL, and four columns allow a sample volume of 60 mL. Even with four columns in series, the sample can be processed in 20 to 30 min with no problems due to back pressure.

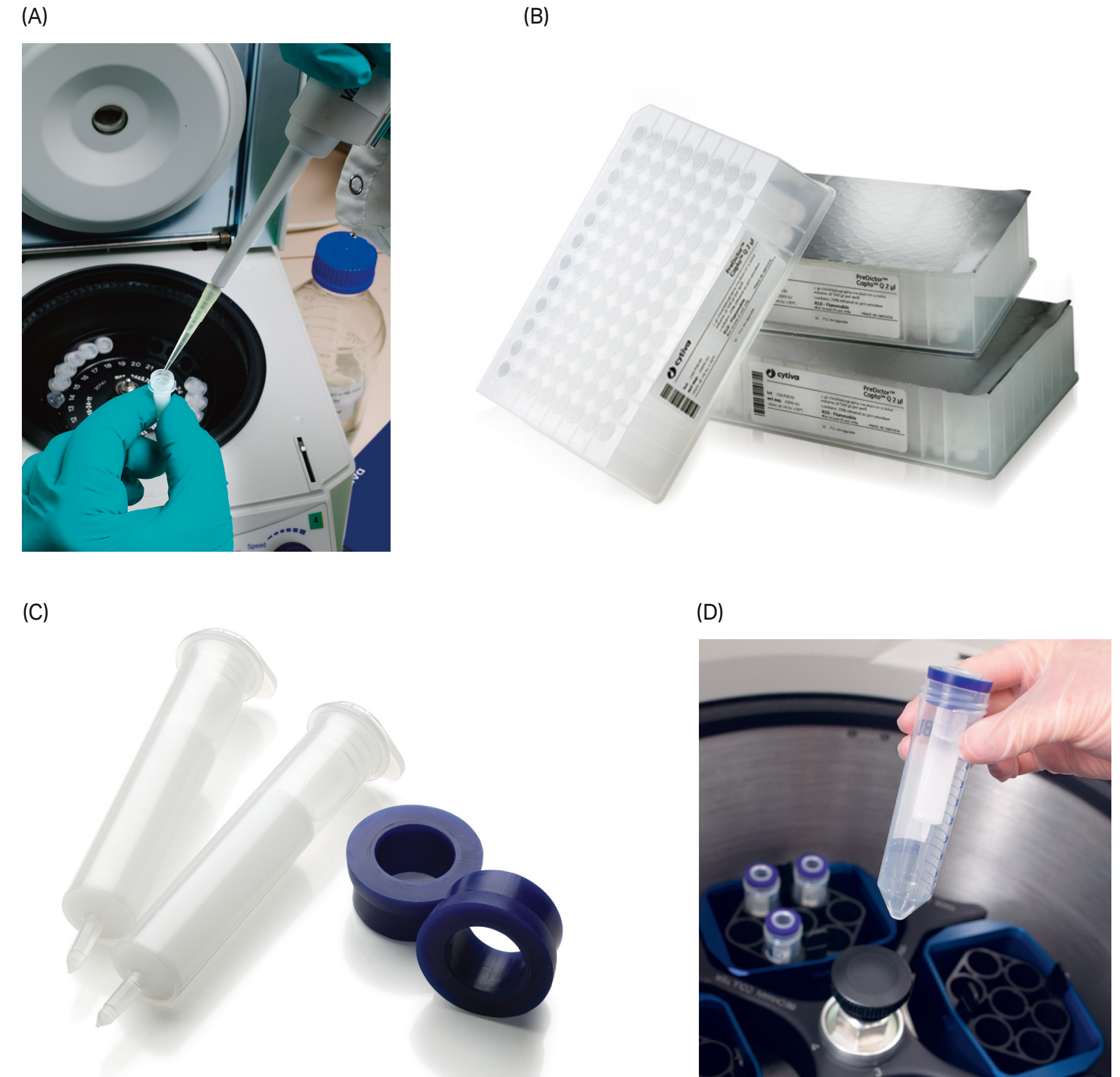
### Buffer preparation

All commonly used aqueous buffers can be used for desalting/buffer exchange. Often a buffer with 25 to 50 mM concentration of the buffering substance is sufficient. A salt concentration of at least 25 mM is recommended to prevent possible ionic interactions with the chromatography medium. Sodium chloride is often used for this purpose. At salt concentrations above 1 M, hydrophobic substances may be retarded or may bind to the chromatography medium. At even higher salt concentrations ( $> 1.5$  M ammonium sulfate), the column packing shrinks.

### Sample preparation

Sample concentration does not influence the separation as long as the viscosity does not differ by more than a factor of 1.5 from that of the buffer used. This corresponds to a maximum concentration of 70 mg/mL for proteins, when normal, aqueous buffers are used.

The sample should be fully solubilized. Centrifuge or filter (0.45  $\mu\text{m}$  filter) immediately before loading to remove particulate material if necessary.



**Fig 11.2.** (A) PD SpinTrap G-25 sample preparation. (B) PD MultiTrap G-25. (C and D) Spin Adapters are used together with PD-10 Desalting columns, PD MidiTrap G-25, and PD MiniTrap G-25 to enable use in a standard centrifuge.



## Buffer exchange

Protein solubility often depends on pH and/or ionic strength (salt concentration), and the exchange of buffer may therefore result in precipitation of the protein. Also, protein activity can be lost if the change of pH takes it outside of the range where the protein is active. Samples that have been obtained after purification will usually be free from particles, unless the purified protein or a contaminant has been aggregated.

The protocols in the following sections describe desalting and buffer exchange using different formats of prepacked columns.

## Small-scale desalting and buffer exchange with PD desalting columns

PD-10 Desalting columns, PD MidiTrap G-25, PD MiniTrap G-25, PD SpinTrap G-25, and PD MultiTrap G-25 columns and 96-well filter plates are prepacked with Sephadex G-25 for group separation of high ( $M_r > 5000$ ) from low molecular weight substances ( $M_r < 1000$ ) by desalting and buffer exchange. PD MiniTrap G-10 and PD MidiTrap G-10 columns contain Sephadex G-10. These prepacked, single-use gravity columns allow desalting/buffer exchange of smaller proteins with  $M_r > 700$ . This collection of columns and plates covers the sample volume range from 70  $\mu\text{L}$  to 2.5 mL and supports processing multiple samples in parallel.

### PD SpinTrap G-25

PD SpinTrap G-25 is a single-use spin column that is designed for rapid, highly reproducible desalting and buffer exchange of 100 to 180  $\mu\text{L}$  samples using a standard microcentrifuge (Fig 11.2 A and 11.3). The columns provide highly reproducible, parallel desalting/buffer exchange and cleanup of protein samples without sample dilution. The spin columns are prepacked with Sephadex G-25 Superfine, an SEC medium that allows effective removal of low molecular weight substances from biomolecules with  $M_r > 5000$ .

Each pack of PD SpinTrap G-25 contains prepacked columns and collection tubes for 50 preparations.




**Fig 11.3.** PD SpinTrap G-25 columns are single-use columns for rapid desalting and buffer exchange of biomolecules with  $M_r > 5000$ .

## Buffer

Equilibration buffer: Buffer of choice


## Desalting procedure

1. Suspend the chromatography medium by vortexing. Loosen screw cap lid and remove bottom closure using the plastic bottom cap removal tool.
2. Place the column in an appropriately sized collection tube and remove the storage solution by centrifugation for 1 min at  $800 \times g$ .
3. Equilibrate by adding 400  $\mu\text{L}$  of equilibration buffer and centrifuge for 1 min at  $800 \times g$ . Discard the flowthrough and replace the collection tube. Repeat this procedure four more times.

 To ensure optimal results, it is critical to equilibrate the spin column with a total of 2 mL of equilibration buffer to completely remove the storage solution.

4. Replace the used collection tube with a new clean collection tube for sample collection.
5. Apply 100 to 180  $\mu\text{L}$  of sample slowly to the middle of the prepacked column.
6. Elute by centrifugation at  $800 \times g$  for 2 min.

Recovery is dependent on type of protein or other biomolecule. Typically, recovery is in the range of 70% to 90%. Concentration of the sample (e.g., using a Vivaspin sample concentrator) can improve recovery. For sample volumes less than 140  $\mu\text{L}$  it is recommended to add equilibration buffer to reach a total volume of 140  $\mu\text{L}$  after the sample has fully absorbed into the column bed.

 For desalting larger sample volumes, use larger-scale PD cleanup and desalting products or HiTrap and HiPrep columns; see Table 11.1. For desalting of multiple samples, use PD MultiTrap G-25.

## PD MultiTrap G-25

PD MultiTrap G-25 96-well plates are designed for high-throughput desalting, buffer exchange, and cleanup of proteins, with high reproducibility well-to-well and plate-to-plate (Fig 11.4). Using the 96-well plates, multiple samples can be run conveniently and reproducibly in parallel (Fig 11.5). PD MultiTrap G-25 can be operated manually or in automated mode using a robotic system equipped with a centrifugation device to desalt or buffer exchange sample volumes ranging from 70 to 130  $\mu\text{L}$ . For sample volumes less than 100  $\mu\text{L}$  it is recommended to apply a stacker volume of equilibration buffer to reach a total of 100  $\mu\text{L}$  after the sample has fully absorbed. Elution can be performed by centrifugation. Although possible to perform, using PD MultiTrap G-25 with vacuum is not recommended due to reduced reproducibility compared with operation using centrifugation.

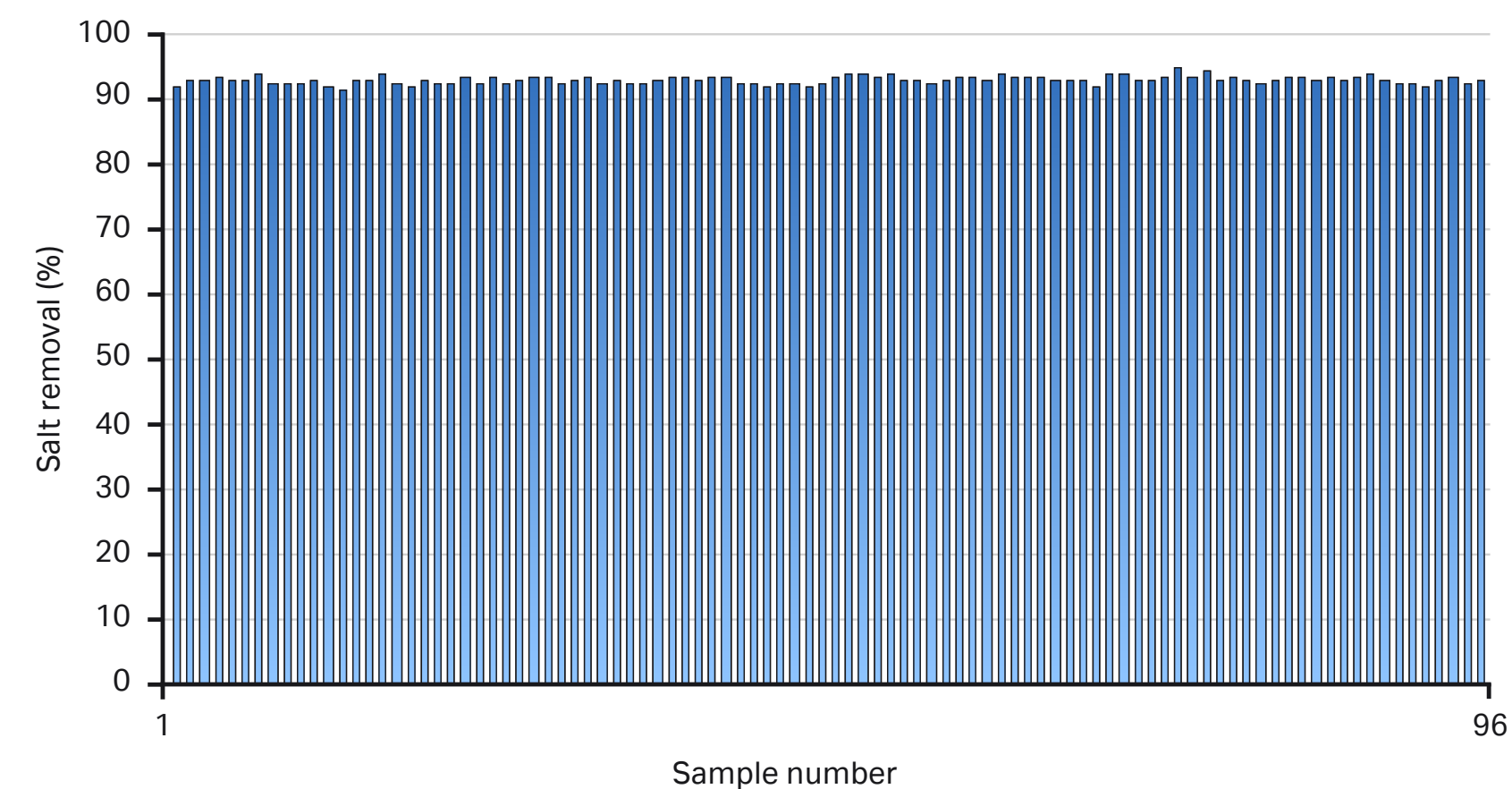
The wells are prepacked with Sephadex G-25 Medium, an SEC medium that allows effective removal of low molecular weight substances from biomolecules with  $M_r > 5000$ .

Each pack of PD MultiTrap G-25 contains four prepacked 96-well plates, allowing desalting or buffer exchange of up to 384 samples.

Convenient collection plates (five per pack) are available separately (see *Ordering information*).



96-well plate:	PD MultiTrap G-25
Sample:	1 mg/mL bovine serum albumin (BSA) in 1 M NaCl
Sample volume:	130 $\mu\text{L}$ in each well
Equilibration buffer:	Ultrapure water



**Fig 11.4.** PD MultiTrap G-25 96-well plates offer rapid, highly reproducible cleanup of biomolecules with  $M_r > 5000$ .

**Fig 11.5.** Removal of NaCl from BSA on a PD MultiTrap G-25 96-well plate showed highly reproducible results. The average desalting capacity was 93% and the well-to-well variation was 1% (relative standard deviation).




## Centrifugation protocol

### Buffer

Equilibration buffer: Buffer of choice


### Desalting procedure

1. Suspend the chromatography medium by gently shaking the plate upside down. Remove top and bottom seals and place plate on the collection plate.
2. Remove the storage solution by centrifugation for 1 min at  $800 \times g$ .
3. Equilibrate by adding 300  $\mu\text{L}$  of equilibration buffer and centrifuge for 1 min at  $800 \times g$ . Discard the flowthrough and replace the collection tube. Repeat this procedure four more times.

 To ensure optimal results, it is critical to equilibrate each well with a total of 1.5 mL of equilibration buffer to completely remove the storage solution.

4. Replace the used collection plate with a new, clean collection plate for sample collection.
5. Apply 70 to 130  $\mu\text{L}$  of sample to the middle of the prepacked wells.
6. Elute by centrifugation at  $800 \times g$  for 2 min.

Recovery is dependent on type of protein or other biomolecule. Typically, the recovery is in the range of 70% to 90%. Concentration of the sample (e.g., using a Vivaspin sample concentrator) can improve recovery. For sample volumes less than 100  $\mu\text{L}$  it is recommended to add equilibration buffer to reach a total volume of 100  $\mu\text{L}$  after the sample has fully absorbed into the column bed.

 For desalting larger sample volumes, use larger-scale PD cleanup and desalting products or HiTrap and HiPrep columns; see Table 11.1.

## PD MiniTrap G-25 and PD MidiTrap G-25

PD MiniTrap G-25 and PD MidiTrap G-25 are designed for convenient desalting and buffer exchange of 100 to 500  $\mu\text{L}$  (PD MiniTrap G-25) and 0.5 to 1.0 mL (PD MidiTrap G-25) volume of protein sample (Fig 11.6). The columns are prepacked with Sephadex G-25 Medium, an SEC medium that allows effective removal of low molecular weight substances from proteins with  $M_r > 5000$ . These columns provide an excellent alternative to PD SpinTrap G-25 columns because of the increased sample volume capacity.

For increased flexibility, the products have two alternative application protocols, using either gravity or centrifugation. The gravity protocol allows simple cleanup of multiple samples in parallel without the need for a purification system. With the centrifugation protocol, samples are run in a standard centrifuge with minimal dilution of the eluted sample.

Each pack of PD MiniTrap G-25 and PD MidiTrap G-25 contains 50 prepacked columns and four adapters that are required when using the centrifugation protocol.



**Fig 11.6.** PD MiniTrap G-25 prepacked columns for cleanup of proteins with  $M_r > 5000$  in sample volumes up to 500  $\mu\text{L}$  (PD MiniTrap G-25; left) and 1.0 mL (PD MidiTrap G-25; right).

## Gravity protocol

### Buffer

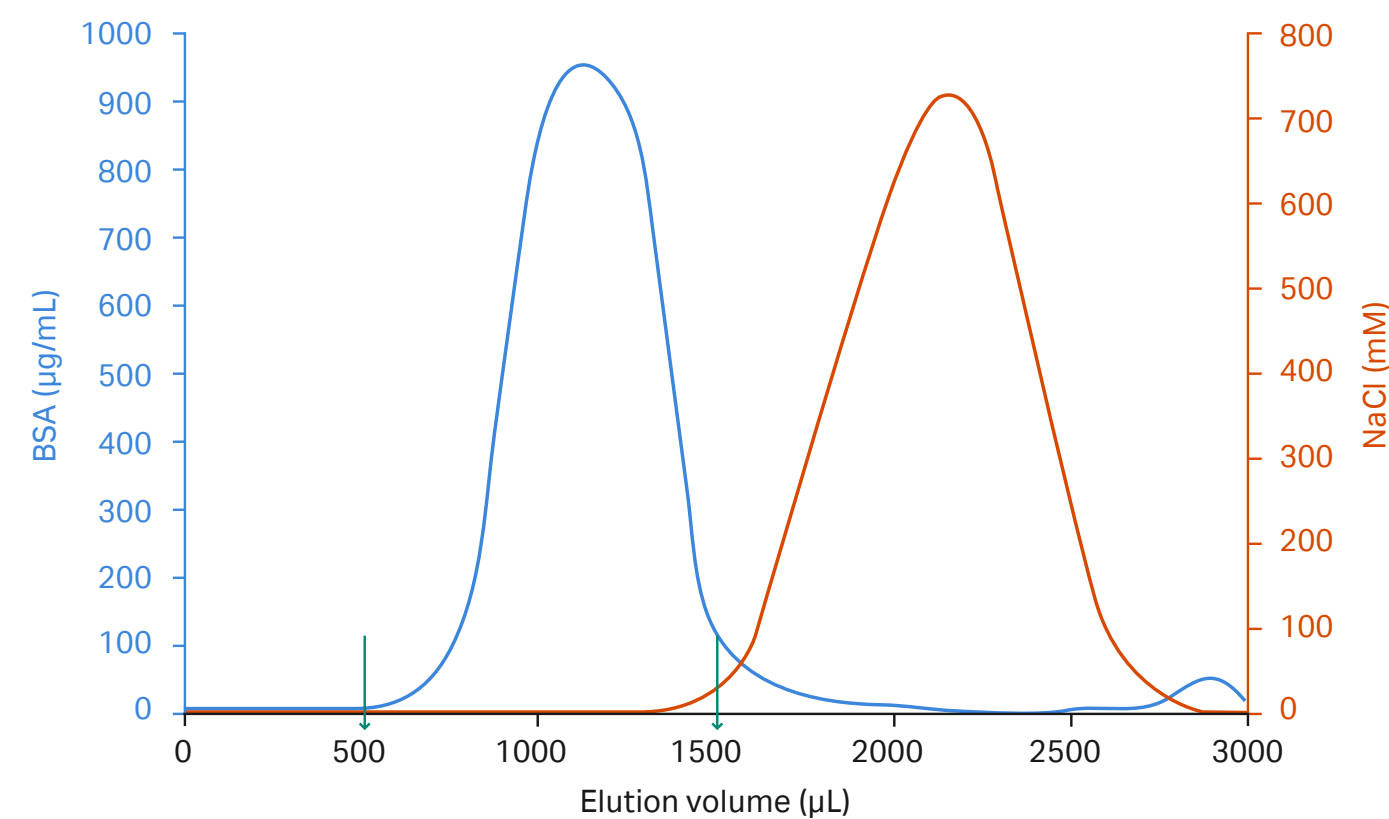
Equilibration buffer: Buffer of choice

### Desalting procedure

1. Remove the top cap and pour off the column storage solution. Remove the bottom cap.
2. Fill the column with equilibration buffer and allow the equilibration buffer to enter the packed bed completely. Repeat twice and discard the flowthrough.  
  
To ensure optimal results, it is critical to equilibrate the column with a total of 8 mL (PD MiniTrap G-25) or 15 mL (PD MidiTrap G-25) of equilibration buffer to completely remove the storage solution.
3. For PD MiniTrap G-25: Add 100 to 500  $\mu\text{L}$  of sample to the column. For sample volumes lower than 500  $\mu\text{L}$ , add equilibration buffer to adjust the volume up to 500  $\mu\text{L}$  *after the sample has entered the packed bed completely*. For PD MidiTrap G-25: Add 0.5 to 1.0 mL of sample to the column. For sample volumes lower than 1.0 mL, add equilibration buffer to adjust the volume up to 1.0 mL *after the sample has entered the packed bed completely*.
4. Allow the sample and equilibration buffer to enter the packed bed completely. Discard the flowthrough.
5. Place a test tube for sample collection under the column and elute with 1 mL (PD MiniTrap G-25) or 1.5 mL (PD MidiTrap G-25) buffer. Collect the desalted sample.

Recovery is dependent on type of protein. Typically, recovery is in the range of 70% to 90%. Concentration of the sample (e.g., using a Vivaspin sample concentrator) can improve recovery. Recovery and desalting capacity are higher when using gravity flow compared with centrifugation. A typical result for desalting of a protein with PD MiniTrap G-25 is shown in Figure 11.7.

Column: PD MiniTrap G-25  
 Sample: 1 mg/mL bovine serum albumin (BSA) in 1 M NaCl  
 Sample volume: 500  $\mu$ L  
 Equilibration buffer: Water (ultrapure)



**Fig 11.7.** Removal of NaCl from BSA using the gravity protocol. The protein recovery was 95%.

## Centrifugation protocol


### Buffer

Equilibration buffer: Buffer of choice

## Desalting procedure

1. Remove the top cap and pour off the column storage solution.
2. Remove the top filter using forceps. Remove the bottom cap.
3. Place the column into a 15 mL (PD MiniTrap G-25) or 50 mL (PD MidiTrap G-25) collection tube and connect the supplied column adapter to the top of the tube.
4. Fill the column with equilibration buffer and allow the equilibration buffer to enter the packed bed completely. Repeat and discard the flowthrough.
5. Fill the column with equilibration buffer again and centrifuge at  $1000 \times g$  for 2 min and discard the flowthrough.  
 To ensure optimal results, it is critical to equilibrate the column with a total of 8 mL (PD MiniTrap G-25) or 15 mL (PD MidiTrap G-25) of equilibration buffer (steps 4 and 5) to completely remove the storage solution.
6. For PD MiniTrap G-25: Add 200 to 500  $\mu$ L of sample slowly to the middle of the packed bed.  
 For PD MidiTrap G-25: Add 0.75 to 1.0 mL of sample slowly to the middle of the packed bed.
7. Place the column into a new 15 mL (PD MiniTrap G-25) or 50 mL (PD MidiTrap G-25) collection tube.
8. Elute by centrifugation  $1000 \times g$  for 2 min and collect the eluate.

Recovery is dependent on type of protein. Typically, recovery is in the range of 70% to 90%. Concentration of the sample (e.g., using a Vivaspin sample concentrator) can improve recovery. Recovery and desalting capacity are higher using gravity flow compared with centrifugation.

 For desalting larger sample volumes, use HiTrap and HiPrep columns; see Table 11.1.



## PD-10 Desalting columns

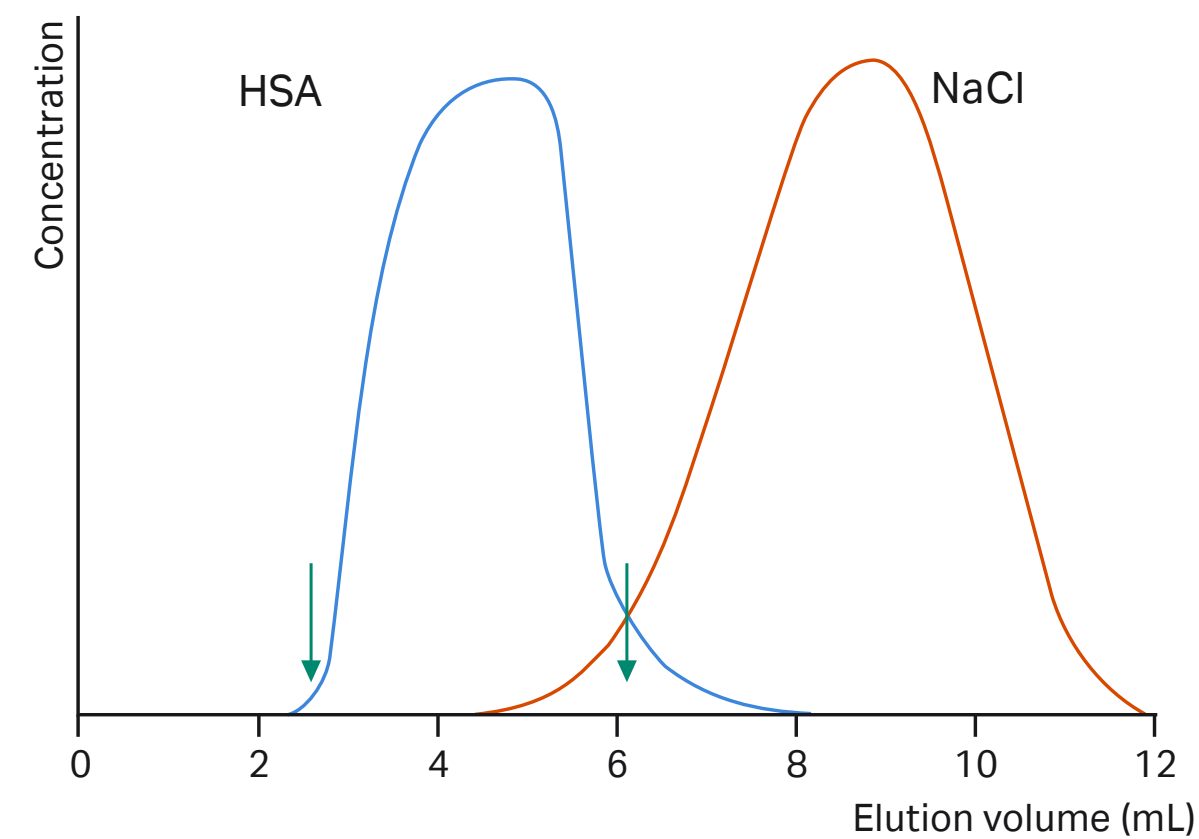
PD-10 Desalting columns are designed for convenient desalting and buffer exchange of 1.0 to 2.5 mL volume of protein sample. The columns are prepacked with Sephadex G-25 Medium, an SEC medium that allows effective removal of low molecular weight substances from proteins with  $M_r > 5000$ . These columns provide an excellent alternative to PD MidiTrap G-25 columns because of the increased sample volume capacity.

For increased flexibility, the product has two alternative application protocols, using either gravity or centrifugation. The gravity protocol allows simple cleanup of multiple samples in parallel without the need for a purification system. Using the centrifugation protocol, samples are run in a standard centrifuge with minimal dilution of the eluted sample.

Each pack of PD-10 Desalting columns contains 30 prepacked columns. To simplify the use of PD-10 Desalting columns with the gravity protocol, LabMate PD-10 Buffer Reservoir may be used (see *Ordering information*). Using the buffer reservoir, wash and equilibration buffers can be applied in one step.

A typical separation is shown in Figure 11.8.

*Column:* PD-10 Desalting column  
*Sample:* Human serum albumin (HSA), 25 mg in 2.5 mL of 0.5 M NaCl  
*Equilibration:* Distilled water



**Fig 11.8.** Removal of NaCl from albumin solution. A PD-10 Desalting column was equilibrated with distilled water. A total of 23.8 mg of albumin was recovered in 3.5 mL of eluent corresponding to a yield of 95.3% (between arrows).

## Gravity protocol

### Buffer

Equilibration buffer: Buffer of choice

### Desalting procedure

1. Cut off bottom tip, remove top cap, and pour off excess liquid.
2. If available, mount the LabMate Buffer Reservoir on top of the PD-10 Desalting column and place the columns in the PD-10 Desalting LabMate.
3. Equilibrate the column with approximately 25 mL of buffer. Discard the flowthrough (use the plastic tray to collect flowthrough).

To ensure optimal results, it is critical to equilibrate the column with a total of 25 mL of equilibration buffer to completely remove the storage solution.

4. Add sample of a total volume of 2.5 mL. If the sample is less than 2.5 mL, add buffer until the total volume of 2.5 mL is achieved. Discard the flowthrough.
5. Elute with 3.5 mL of buffer and collect the flowthrough.

Recovery is dependent on type of protein. Typically, recovery is in the range of 70% to 90%. Concentration of the sample (e.g., using a Vivaspin sample concentrator) can improve recovery. Recovery and desalting capacity are higher using gravity flow compared with centrifugation.

 For desalting larger sample volumes, use HiTrap and HiPrep columns; see Table 11.1.

## Centrifugation protocol

### Buffer

Equilibration buffer: Buffer of choice


### Desalting procedure

1. Remove the top cap and pour off the column storage solution.
2. Remove the top filter using forceps. Remove the bottom cap.
3. Place the PD-10 Desalting column into a 50 mL collection tube and connect the supplied column adapter to the top of the tube.
4. Fill the column with equilibration buffer and allow the equilibration buffer to enter the packed bed completely. Repeat three times, discarding the flowthrough each time.
5. Fill the column with equilibration buffer again and centrifuge at  $1000 \times g$  for 2 min and discard the flowthrough.

To ensure optimal results, it is critical to equilibrate the column with a total of 25 mL of equilibration buffer (steps 4 and 5) to completely remove the storage solution.

6. Add 1.75 to 2.5 mL of sample slowly to the middle of the packed bed.
7. Place the PD-10 Desalting column into a new 50 mL collection tube.
8. Elute by centrifugation  $1000 \times g$  for 2 min and collect the eluate.

Recovery is dependent on type of protein. Typically, recovery is in the range of 70% to 90%. Concentration of the sample (e.g., using a Vivaspin sample concentrator) can improve recovery. Recovery and desalting capacity are higher using gravity flow compared with centrifugation.

 For desalting larger sample volumes, use HiTrap and HiPrep columns; see Table 11.1.

### PD MiniTrap G-10 and PD MidiTrap G-10

PD MiniTrap G-10 and PD MidiTrap G-10 are designed for convenient desalting and buffer exchange of 100 to 300  $\mu\text{L}$  (PD MiniTrap G-10) or 0.4 to 1.0 mL (PD MidiTrap G-10) volume of protein sample (Fig 11.9). The columns are prepacked with Sephadex G-10 Medium, an SEC medium that allows effective removal of low molecular weight substances from proteins with  $M_r > 700$ . Each pack of PD MiniTrap G-10 and PD MidiTrap G-10 contains 50 prepacked columns.



**Fig 11.9.** PD MidiTrap G-10 (left) and PD MiniTrap G-10 (right) columns are prepacked with Sephadex G-10.



## Gravity protocol

### Buffer

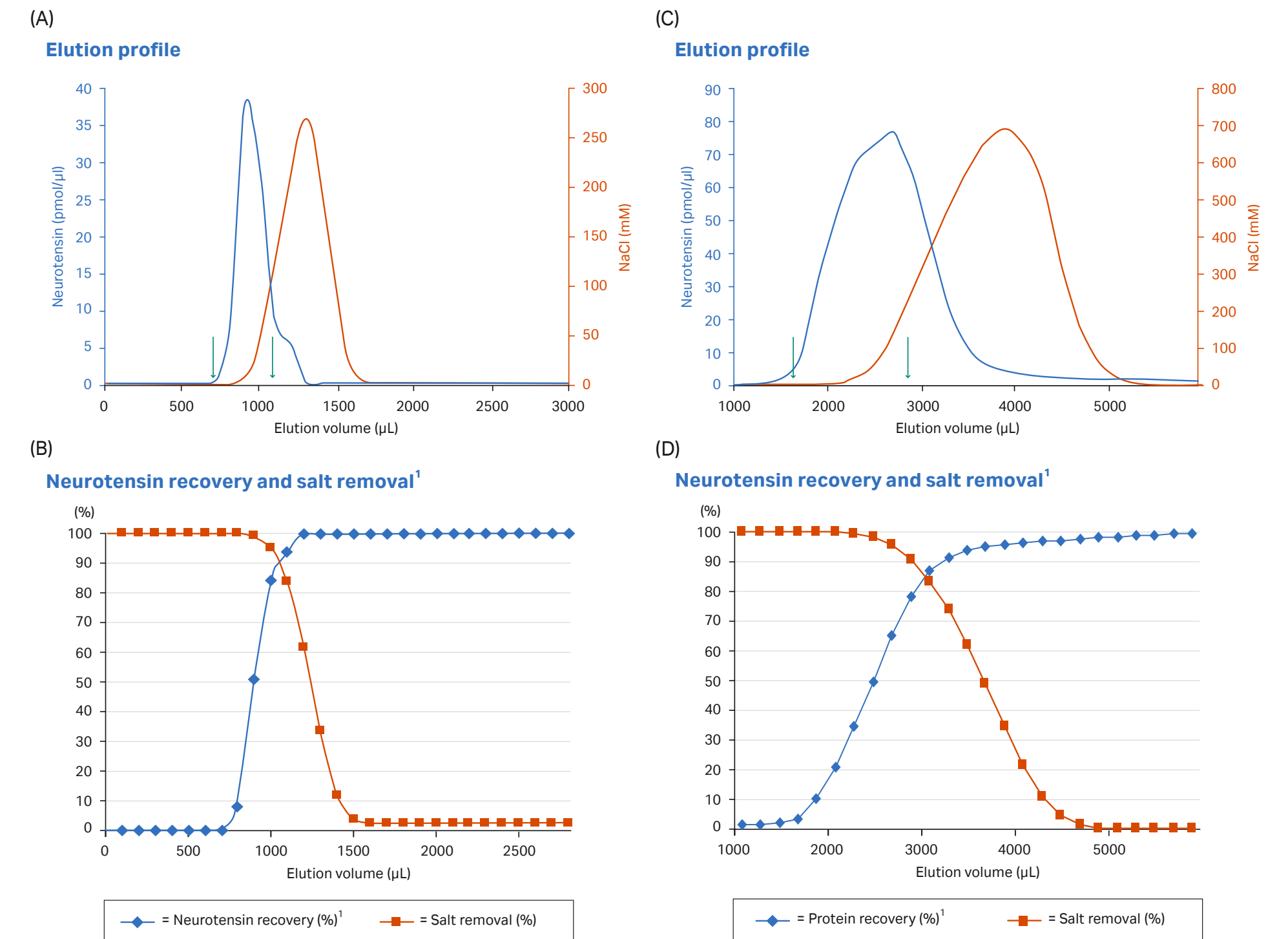
Equilibration buffer: Buffer of choice

### Desalting procedure

1. Resuspend the medium by shaking the column. Allow the medium to settle. Remove the top and bottom caps, and allow the storage solution to flow out.
2. Fill the column with equilibration buffer and allow the equilibration buffer to enter the packed bed completely. Repeat twice and discard the flowthrough.  
To ensure optimal results, it is critical to equilibrate the column with 8 mL (PD MiniTrap G-10) or 16 mL (PD MidiTrap G-10) of equilibration buffer to completely remove the storage solution.
3. For PD MiniTrap G-10: Add a maximum of 300  $\mu\text{L}$  of sample to the column. Add equilibration buffer to adjust the volume up to 700  $\mu\text{L}$  *after the sample has entered the packed bed completely*.  
For PD MidiTrap G-10: Add a maximum of 1.0 mL of sample to the column. Add equilibration buffer to adjust the volume up to 1.7 mL *after the sample has entered the packed bed completely*.
4. Allow the sample and equilibration buffer to enter the packed bed completely. Discard the flowthrough.
5. Place a test tube for sample collection under the column and elute with 0.5 mL (PD MiniTrap G-10) or 1.2 mL (PD MidiTrap G-10) of buffer. Collect the desalted sample.

Sample: 100 pmol/ $\mu\text{L}$  neurotensin in 1 M NaCl  
Sample volume: 100  $\mu\text{L}$   
Equilibration buffer: Milli-Q™ water

Sample: 100 pmol/ $\mu\text{L}$  neurotensin in 1 M NaCl  
Sample volume: 1000  $\mu\text{L}$   
Equilibration buffer: Milli-Q water



**Fig 11.10.** Removal of NaCl from a neurotensin (a 13 amino acid neuropeptide) solution. The neurotensin recovery was 81% and the desalting capacity was 84% (between arrows) for the PD MiniTrap G-10 (A and B). For the PD MidiTrap G-10 (C and D) neurotensin recovery was 79% and desalting capacity was 91% (between arrows). The recovery was calculated by measuring the absorbance at 215 nm, and the desalting capacity was measured by conductivity. Graphs B and D show neurotensin recovery and salt removal versus the total elution volume on the column for PD MiniTrap G-10 and PD MidiTrap G-10, respectively.

## HiTrap Desalting columns

HiTrap Desalting is a 5 mL column (Fig 11.11) packed with the SEC medium Sephadex G-25 Superfine, which is based on cross-linked dextran beads. The fractionation range for globular proteins is between  $M_r$  1000 and 5000, with an exclusion limit of approximately  $M_r$  5000. This ensures group separations of proteins/peptides larger than  $M_r$  5000 from molecules with a molecular weight less than  $M_r$  1000.

HiTrap Desalting can be used with aqueous solutions in the pH range 2 to 13. The prepacked medium is stable in all commonly used buffers, solutions of urea (8 M), Gua-HCl (6 M), and all nonionic and ionic detergents. Lower alcohols (methanol, ethanol, propanol) can be used in the buffer or the sample, but we recommend that the concentration be kept below 25% v/v. Prolonged exposure (hours) to pH below 2 or above 13, or to oxidizing agents, should be avoided.

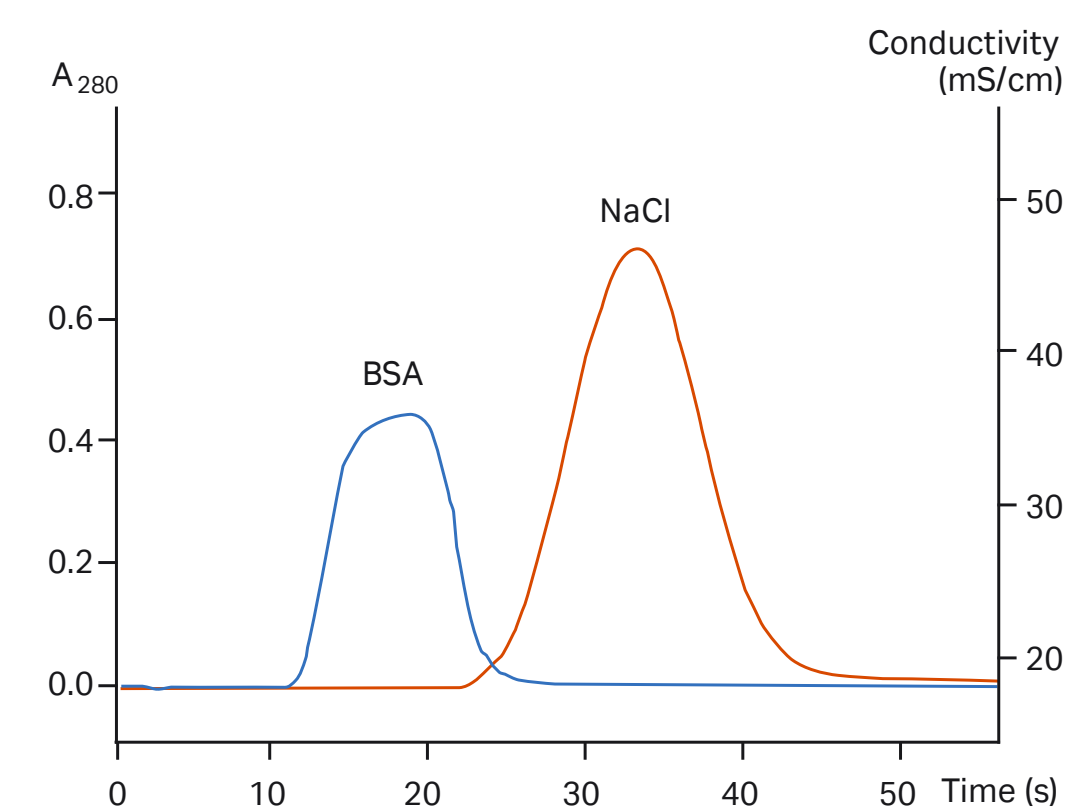
The recommended range of sample volumes is 0.1 to 1.5 mL when complete removal of low molecular weight components is desired. The separation is not affected by the flow rate, in the range of 1 to 10 mL/min. The maximum recommended flow rate is 15 mL/min. Separations are easily performed with a syringe, pump, or chromatography system. Up to three columns can be connected in series, allowing larger sample volumes to be handled. To avoid cross-contamination, use the column only with the same type of sample.

Figure 11.12 shows a typical desalting and buffer exchange separation achieved using HiTrap Desalting and monitored by following changes in UV absorption and conductivity.



**Fig 11.11.** HiTrap Desalting column allows efficient, easy-to-perform group separations with a syringe, pump, or chromatography system.

*Column:* HiTrap Desalting  
*Sample:* 2 mg/mL BSA in 50 mM sodium phosphate, 500 mM NaCl, pH 7.0  
*Sample volume:* 1.4 mL  
*Buffer:* 50 mM sodium phosphate, 150 mM NaCl, pH 7.0  
*Flow rate:* 10 mL/min  
*Detection:* UV (280 nm, 5 mm cell) and conductivity



**Fig 11.12.** Highly efficient desalting in 30 s using HiTrap Desalting.

## Buffer

Equilibration buffer: Buffer of choice

## Column equilibration

1. Fill the syringe or pump tubing with buffer. Remove the stopper. To avoid introducing air into the column, connect the column "drop to drop" to either the syringe (via the connector) or to the pump tubing.
2. Remove the snap-off end at the column outlet.
3. Wash the column with 25 mL of buffer at 5 mL/min to completely remove the storage buffer, which contains 20% ethanol<sup>1</sup>. If air is trapped in the column, wash with degassed buffer until the air disappears. Air introduced into the column by accident during sample application does not influence the separation.


<sup>1</sup> 5 mL/min corresponds to approximately 120 drops/min when using a HiTrap 5 mL column.


## Manual desalting using a syringe

1. To operate the column with a syringe, connect the syringe to the column using the supplied connector.
2. Equilibrate the column; see above, *Column equilibration*.
3. Apply the sample using a 2 to 5 mL syringe at a flow rate between 1 and 10 mL/min<sup>1</sup>. Discard the liquid eluted from the column. If the sample volume is less than 1.5 mL, change to buffer and proceed with the injection until a total of 1.5 mL has been eluted. Discard the eluted liquid.
4. Elute the protein with the appropriate volume selected from Table 11.2. Collect the desalted protein.

<sup>1</sup> 5 mL/min corresponds to approximately 120 drops/min when using a HiTrap 5 mL column.



 The maximum recommended sample volume when using one HiTrap Desalting 5 mL column is 1.5 mL. See Table 11.2 for information on application of smaller sample volumes.

 The void volume of the column is 1.5 mL. High molecular weight components elute between 1.5 and 4.5 mL, depending on the sample volume. Low molecular weight components start to elute after 3.5 mL.

Certain types of molecules, such as small heterocyclic or homocyclic aromatic compounds (purines, pyrimidines, dyes) can interact with Sephadex and are therefore eluted later than expected. Larger sample volumes can be used in these cases, but the separation has to be optimized for each type of contaminating compound.

### Desalting using a pump

1. Equilibrate the column: see *Column equilibration* on the previous page.
2. Apply up to 1.5 mL of sample. Monitor the effluent from the column with a UV monitor and/or a conductivity monitor. Keep the flow rate in range 1 to 10 mL/min. Collect fractions.
3. Elute the column with approximately 10 mL of buffer before applying the next sample. Collect fractions.

## Scaling up desalting from HiTrap to HiPrep Desalting

For separation of sample volumes larger than 1.5 mL, or to increase the resolution between high and low molecular weight components, up to three HiTrap Desalting columns can easily be connected in series. For syringe operations, the volumes suggested in Table 11.2 should be increased proportionally and the recommended flow rate maintained.

The dilution of the sample is dependent on the sample volume and the number of columns used in series. Lower dilution factors than those proposed in Table 11.2 can be obtained, but the elution volumes have to be optimized for each combination of sample volume and number of columns in series. The back pressure for each column is approximately 0.25 bar at 10 mL/min.

HiPrep 26/10 Desalting is packed with Sephadex G-25 Fine. It provides group separation of high ( $M_r > 5000$ ) from low molecular weight substances ( $M_r < 1000$ ), allowing reliable and reproducible desalting and buffer exchange with sample sizes of 15 mL per column. Two to four columns can be used in series (Table 11.1) for sample volumes of 30 to 60 mL.

**Table 11.2.** Recommended sample and elution volumes using HiTrap Desalting with a syringe, with examples of typical yields and remaining salt in the desalted sample

Sample load (mL)	Add buffer (mL)	Elute and collect (mL)	Yield (%)	Remaining salt (%)	Dilution factor
0.25	1.25	1.0	> 95	0.0	4.0
0.50	1.0	1.5	> 95	< 0.1	3.0
1.00	0.5	2.0	> 95	< 0.2	2.0
1.50	0.0	2.0	> 95	< 0.2	1.3

## Protein sample concentration

Vivaspin sample concentrators are designed for fast, nondenaturing concentration of biological samples by membrane ultrafiltration. Up to 30-fold concentration of the sample can be achieved with recovery of the target molecule typically exceeding 95%. The entire process is performed in a single tube with an upper compartment containing sample and lower compartment separated by a semipermeable membrane with a molecular weight cutoff (MWCO) selected by the user. Centrifugation is applied to force solvent through the membrane, leaving a more concentrated sample in the upper chamber.

Vivaspin sample concentrators can be used with sample volumes from 100  $\mu$ L to 20 mL, with a range of MCWO values from  $M_r$  3000 to 100 000. All products are available with MCWO values of 3000, 5000, 10 000, 30 000, 50 000, and 100 000 (see Table 11.3).

1. Select the most appropriate membrane cut-off for your sample. For maximum recovery select a MWCO at least 50% smaller than the molecular size of the species of interest.
2. Fill concentrator with up to the maximum volumes shown in Appendix 12, Table A12.1. (Ensure lid is fully seated.)
3. Insert the assembled concentrator into centrifuge.  
*Note: If using a fixed angle rotor, angle concentrator so that the printed window faces upward/outward.*
4. Set centrifugation speed as recommended in Appendix 12, Table A12.2, taking care not to exceed the maximum g-force indicated.
5. Set centrifugation time (concentration time) after consulting Appendix 12, Table A12.3 to Table A12.6 for typical recoveries for various combinations of proteins, Vivaspin products, and filters.
6. Concentrate samples by using centrifugation speed and time set in steps 4 and 5.
7. Remove assembly and recover sample from the bottom of the concentrate pocket with a pipette. The filtrate tube can be sealed for storage.



**Fig 11.13.** Vivaspin sample concentrators provide up to 30-fold concentration of the sample with recovery of the target molecule typically exceeding 95%.

**Table 11.3.** Vivaspin columns and sample volume ranges

Product	Sample volume range
Vivaspin 500	100 to 500 $\mu$ L
Vivaspin 2	400 $\mu$ L to 2 mL
Vivaspin 6	2 to 6 mL
Vivaspin 20	5 to 20 mL

**12**

# Appendix



## Appendix 1

# Characteristics of Ni Sepharose, Ni Sepharose excel, TALON Superflow, and uncharged IMAC Sepharose products

## Ni Sepharose products

Ni Sepharose High Performance is recommended for high-resolution purification of histidine-tagged proteins, providing sharp peaks and concentrated eluate. Ni Sepharose 6 Fast Flow is excellent for scaling up and batch purifications. Ni Sepharose excel is designed for capture and purification of histidine-tagged proteins secreted into eukaryotic cell culture supernatants. Two magnetic bead formats are also available: His Mag Sepharose Ni and His Mag Sepharose excel.

Table A1.1 summarizes key characteristics of bulk Ni Sepharose High Performance and Ni Sepharose 6 Fast Flow chromatography media, and Table A1.2 lists the stability of these media under various conditions. Tables A1.3 to A1.11 summarize the characteristics of these same media as prepacked columns, prepacked 96-well plates, and magnetic beads. For more information, refer to Chapter 3.

**Table A1.1.** Characteristics of Ni Sepharose High Performance and Ni Sepharose 6 Fast Flow

Characteristics	Ni Sepharose High Performance	Ni Sepharose 6 Fast Flow
Matrix	Highly cross-linked 6% agarose, precharged with Ni <sup>2+</sup>	Highly cross-linked 6% agarose, precharged with Ni <sup>2+</sup>
Metal ion capacity	Approx. 15 μmol Ni <sup>2+</sup> /mL medium	Approx. 15 μmol Ni <sup>2+</sup> /mL medium
Average particle size	34 μm	90 μm
Dynamic binding capacity <sup>1</sup>	At least 40 mg (histidine) <sub>6</sub> -tagged protein/mL medium	Approx. 40 mg (histidine) <sub>6</sub> -tagged protein/mL medium
Recommended flow velocity <sup>2</sup>	< 150 cm/h	50 – 400 cm/h
Compatibility during use	Stable in all commonly used buffers, reducing agents, denaturing agents, and detergents. See Table A1.2 for more information.	Stable in all commonly used buffers, reducing agents, denaturing agents, and detergents. See Table A1.2 for more information.
Chemical stability <sup>3</sup>	For 1 wk at 40°C: 0.01 M HCl, 0.1 M NaOH For 12 h: 1 M NaOH, 70% acetic acid 30 min tested: 30% 2-propanol 1 h tested: 2% SDS	For 1 wk at 40°C: 0.01 M HCl, 0.1 M NaOH For 12 h: 1 M NaOH, 70% acetic acid 30 min tested: 30% 2-propanol 1 h tested: 2% SDS
pH stability <sup>3</sup>	Short term (< 2 h) 2–14 Long term (< 1 wk) 3–12	Short term (< 2 h) 2–14 Long term (< 1 wk) 3–12
Storage	20% ethanol	20% ethanol
Storage temperature	4°C to 30°C	4°C to 30°C

<sup>1</sup> Dynamic binding capacity conditions:

*Sample:* 1 mg/mL (histidine)<sub>6</sub>-tagged pure protein (M<sub>r</sub> 43 000) in binding buffer or (histidine)<sub>6</sub>-tagged protein (M<sub>r</sub> 28 000) bound from *E. coli* extract. Capacity determined at 10% breakthrough.

*Column volume:* 0.25 mL or 1 mL

*Flow rate:* 0.25 mL/min or 1 mL/min, respectively

*Binding buffer:* 20 mM sodium phosphate, 0.5 M NaCl, 5 mM imidazole, pH 7.4

*Elution buffer:* 20 mM sodium phosphate, 0.5 M NaCl, 500 mM imidazole, pH 7.4

Note: Dynamic binding capacity is protein dependent.

<sup>2</sup> H<sub>2</sub>O at room temperature.

<sup>3</sup> Ni<sup>2+</sup>-stripped medium.

**Table A1.2.** Compatibility guide: Ni Sepharose High Performance, Ni Sepharose 6 Fast Flow, and His Mag Sepharose Ni are stable toward these compounds at least at the concentrations given

Compound	Concentration
Reducing agents <sup>1</sup>	5 mM DTE
	5 mM DTT
	20 mM β-mercaptoethanol
	5 mM TCEP (Tris[carboxyethyl] phosphine)
	10 mM reduced glutathione
Denaturing agents	8 M urea <sup>2</sup>
	6 M Gua-HCl <sup>2</sup>
Detergents	2% Tween 20 (nonionic)
	2% NP-40 (nonionic)
	2% cholate (anionic)
	1% CHAPS (zwitterionic)
Other additives	500 mM imidazole
	20% ethanol
	50% glycerol
	100 mM Na <sub>2</sub> SO <sub>4</sub>
	1.5 M NaCl
	1 mM EDTA <sup>3</sup>
Buffers	60 mM citrate <sup>2</sup>
	50 mM sodium phosphate, pH 7.4
	100 mM Tris-HCl, pH 7.4
	100 mM Tris-acetate, pH 7.4
	100 mM HEPES, pH 7.4
100 mM MOPS, pH 7.4	
100 mM sodium acetate, pH 4 <sup>2</sup>	

<sup>1</sup> Before performing runs with sample/buffers containing reducing reagents, a blank run with binding and elution buffers excluding reducing agents is recommended (see, for example, Table 3.2).

<sup>2</sup> Tested for 1 wk at 40°C.

<sup>3</sup> The strong chelator EDTA has been used successfully in some cases, at 1 mM. Generally, chelating agents should be used with caution (and only in the sample, not in the buffer). Any metal-ion stripping may be counteracted by adding a small excess of MgCl<sub>2</sub> before centrifugation/filtration of the sample. Note that stripping effects may vary with the applied sample volume.

**Table A1.3.** Characteristics of His MultiTrap HP and His MultiTrap FF

Chromatography media	His MultiTrap HP: Ni Sepharose High Performance His MultiTrap FF: Ni Sepharose 6 Fast Flow; see Table A1.1 for details
Filter plate size <sup>1</sup>	127.8 × 85.5 × 30.6 mm
Filter plate material	Polypropylene and polyethylene
Binding capacity <sup>2</sup>	His MultiTrap HP: Up to 1 mg histidine-tagged protein/well His MultiTrap FF: Up to 0.8 mg histidine-tagged protein/well
Reproducibility between wells	+/- 10%
Volume packed medium/well	50 μL
Number of wells	96
Well volume	800 μL
Max. sample loading volume	600 μL
pH stability <sup>3</sup>	2–14 (short term), 3–12 (long term)
Storage	20% ethanol
Storage temperature	4°C to 30°C

<sup>1</sup> According to ANSI/SBS 1-2004, 3-2004, and 4-2004 standards (ANSI = American National Standards Institute and SBS = Society for Biomolecular Screening).

<sup>2</sup> Protein binding capacity is protein dependent.

<sup>3</sup> Ni<sup>2+</sup>-stripped medium.

**Table A1.4.** Characteristics of His SpinTrap

Chromatography medium	Ni Sepharose High Performance; see Table A1.1 for details
Average particle size	34 μm
Bed volume	100 μL
Column material	Polypropylene barrel and polyethylene frits
Protein binding capacity <sup>1</sup>	Approx. 0.75 mg histidine-tagged protein/column
Compatibility during use	Stable in all commonly used buffers, reducing agents, denaturants, and detergents. See Table A1.2 for more information.
Storage	0.15% Kathon™ CG
Storage temperature	4°C to 30°C

<sup>1</sup> Protein binding capacity is protein dependent.

**Table A1.5.** Characteristics of HisTrap HP and HisTrap FF

Chromatography media	HisTrap HP: Ni Sepharose High Performance HisTrap FF: Ni Sepharose 6 Fast Flow; see Table A1.1 for details
Column volume	1 mL and 5 mL
Column dimensions	0.7 × 2.5 cm (1 mL); 1.6 × 2.5 cm (5 mL)
Dynamic binding capacity <sup>1</sup>	HisTrap HP: At least 40 mg histidine-tagged protein/mL medium HisTrap FF: Approx. 40 mg histidine-tagged protein/mL medium
Recommended flow rate	1 mL/min (1 mL); 5 mL/min (5 mL)
Max. flow rate <sup>2</sup>	4 mL/min (1 mL); 20 mL/min (5 mL)
Max. pressure <sup>2</sup>	0.3 MPa, 3 bar
pH stability <sup>3</sup>	2–14 (short term), 3–12 (long term)
Compatibility	Stable in all commonly used buffers, reducing agents, denaturants, and detergents. See Table A1.2 for more information.
Chemical stability <sup>3</sup>	For 1 wk at 40°C: 0.01 M HCl, 0.1 M NaOH For 12 h: 1 M NaOH, 70% acetic acid 30 min tested: 30% 2-propanol 1 h tested: 2% SDS
Storage	20% ethanol
Storage temperature	4°C to 30°C

<sup>1</sup> Dynamic binding capacity conditions:

*Sample:* 1 mg/mL (histidine)<sub>6</sub>-tagged pure protein (M<sub>r</sub> 43 000) in binding buffer or (histidine)<sub>6</sub>-tagged protein (M<sub>r</sub> 28 000) bound from *E. coli* extract. Capacity determined at 10% breakthrough.

*Column volume:* 0.25 mL or 1 mL

*Flow rate:* 0.25 mL/min or 1 mL/min, respectively

*Binding buffer:* 20 mM sodium phosphate, 0.5 M NaCl, 5 mM imidazole, pH 7.4

*Elution buffer:* 20 mM sodium phosphate, 0.5 M NaCl, 500 mM imidazole, pH 7.4

Note: Dynamic binding capacity is protein dependent.

<sup>2</sup> H<sub>2</sub>O at room temperature.

<sup>3</sup> Ni<sup>2+</sup>-stripped medium.

**Table A1.6.** Characteristics of HisTrap FF crude

Chromatography medium	Ni Sepharose 6 Fast Flow; see Table A1.1 for details
Average particle size	90 µm
Column volume	1 mL and 5 mL
Column dimensions	0.7 × 2.5 cm (1 mL); 1.6 × 2.5 cm (5 mL)
Dynamic binding capacity <sup>1</sup>	Approx. 40 mg histidine-tagged protein/mL medium
Recommended flow rate <sup>2</sup>	1 mL/min (1 mL); 5 mL/min (5 mL)
Max. pressure <sup>2</sup>	3 bar (0.3 MPa, 42 psi)
Compatibility during use	Stable in all commonly used buffers, reducing agents, denaturing agents, and detergents. See Table A1.2 for more information.
Chemical stability <sup>3</sup>	For 1 wk at 40°C: 0.01 M HCl, 0.1 M NaOH For 12 h: 1 M NaOH, 70% acetic acid 30 min tested: 30% 2-propanol 1 h tested: 2% SDS
pH stability <sup>3</sup>	2–14 (short term), 3–12 (long term)
Storage	20% ethanol
Storage temperature	4°C to 30°C

<sup>1</sup> Dynamic binding capacity conditions:

*Sample:* 1 mg/mL (histidine)<sub>6</sub>-tagged pure protein (M<sub>r</sub> 43 000) in binding buffer or (histidine)<sub>6</sub>-tagged protein (M<sub>r</sub> 28 000) bound from *E. coli* extract. Capacity determined at 10% breakthrough.

*Column volume:* 0.25 mL or 1 mL

*Flow rate:* 0.25 mL/min or 1 mL/min, respectively

*Binding buffer:* 20 mM sodium phosphate, 0.5 M NaCl, 5 mM imidazole, pH 7.4

*Elution buffer:* 20 mM sodium phosphate, 0.5 M NaCl, 500 mM imidazole, pH 7.4

Note: Dynamic binding capacity is protein dependent.

<sup>2</sup> H<sub>2</sub>O at room temperature.

<sup>3</sup> Ni<sup>2+</sup>-stripped medium.

**Table A1.7.** Characteristics and contents of HisTrap FF crude Kit

Contents of kit	3 × 1 mL HisTrap FF crude columns <sup>1</sup> 2 × 50 mL phosphate buffer, 8× stock, pH 7.4 50 mL 2 M imidazole, pH 7.4 1 syringe, 5 mL Connectors Instructions
-----------------	--

<sup>1</sup> See Table A1.6 for the characteristics of HisTrap FF crude columns.

**Table A1.8.** Characteristics of His GraviTrap

Chromatography medium	Ni Sepharose 6 Fast Flow; see Table A1.1 for details
Average particle size	90 µm
Bed volume	1 mL
Column material	Polypropylene barrel, polyethylene frits
Protein binding capacity <sup>1</sup>	Approx. 40 mg histidine-tagged protein/column
Compatibility during use	Stable in all commonly used buffers, reducing agents, denaturing agents and detergents. See Table A1.2 for more information.
Chemical stability <sup>2</sup>	For 1 wk at 40°C: 0.01 M HCl, 0.1 M NaOH For 12 h: 1 M NaOH, 70% acetic acid 30 min tested: 30% 2-propanol 1 h tested: 2% SDS
Storage	20% ethanol
Storage temperature	4°C to 30°C

<sup>1</sup> Protein binding capacity is protein dependent.

<sup>2</sup> Ni<sup>2+</sup>-stripped medium.

**Table A1.9.** Characteristics of HiScreen Ni FF

Medium	Ni Sepharose 6 Fast Flow; see Table A1.1 for details
Matrix	Highly cross-linked 6% agarose
Particle size, d <sub>50v</sub> <sup>1</sup>	90 µm
Dynamic binding capacity <sup>2</sup>	Approx. 40 mg (histidine) <sub>6</sub> -tagged protein/mL medium
Metal ion capacity	Approx. 15 µmol Ni <sup>2+</sup> /mL medium
Recommended flow velocity <sup>3</sup>	30 to 300 cm/h
Maximum flow velocity <sup>3</sup>	450 cm/h
Maximum pressure over the packed bed during operation, Δp <sup>4</sup>	0.15 MPa, 1.5 bar, 22 psi
HiScreen column hardware pressure limit	0.5 MPa, 5 bar, 73 psi
pH stability <sup>5</sup> (for medium without metal ion)	
- short term (at least 2 h)	2–14
- long term (≤ 1 wk)	3–12

**Table A1.9.** Characteristics of HiScreen Ni FF (*cont.*)

Compatibility during use	Stable in all commonly used buffers, reducing agents, denaturants, and detergents. See Table A1.2 for more information.
Chemical stability (for medium without metal ion)	12 h tested: 1 M NaOH, 70% acetic acid 1 h tested: 2% SDS 30 min tested: 30% 2-propanol
Avoid in buffers	Chelating agents, e.g., EDTA <sup>6</sup> , EGTA, citrate
Storage	4°C to 30°C in 20% ethanol

<sup>1</sup> d<sub>50v</sub> is the average particle size of the cumulative volume distribution.

<sup>2</sup> Dynamic binding capacity conditions:

*Samples:* 1 mg/mL (histidine)<sub>6</sub>-tagged pure protein (M<sub>r</sub> 43 000) in binding buffer (QB, 10% determination) or (histidine)<sub>6</sub>-tagged protein (M<sub>r</sub> 28 000) bound from *E. coli* extract.

*Column volumes:* 0.25 or 1 mL

*Flow rates:* 0.25 or 1 mL/min, respectively

*Binding buffer:* 20 mM sodium phosphate, 500 mM NaCl, 5 mM imidazole, pH 7.4

*Elution buffer:* 20 mM sodium phosphate, 500 mM NaCl, 500 mM imidazole, pH 7.4

Note: Dynamic binding capacity is protein dependent.

<sup>3</sup> H<sub>2</sub>O at room temperature.

<sup>4</sup> Many chromatography systems are equipped with pressure gauges to measure the pressure at a particular point in the system, usually just after the pumps. The pressure measured here is the sum of the pre-column pressure, the pressure drop over the medium bed, and the post-column pressure. It is always higher than the pressure drop over the bed alone. We recommend keeping the pressure drop over the bed below 1.5 bar. Setting the upper limit of your pressure gauge to 1.5 bar will ensure the pump shuts down before the medium is overpressured. If necessary, post-column pressure of up to 3.5 bar can be added to the limit without exceeding the column hardware limit. To determine post-column pressure, proceed as follows:

To avoid breaking the column, the post-column pressure must never exceed 3.5 bar.

1. Connect a piece of tubing in place of the column.
2. Run the pump at the maximum flow you intend to use for chromatography. Use a buffer with the same viscosity as you intend to use for chromatography. Note the back pressure as total pressure.
3. Disconnect the tubing and run at the same flow rate used in step 2. Note this back pressure as pre-column pressure.
4. Calculate the post-column pressure as total pressure minus pre-column pressure. If the post-column pressure is higher than 3.5 bar, take steps to reduce it (shorten tubing, clear clogged tubing, or change flow restrictors), and perform steps 1 to 4 again until the post-column pressure is below 3.5 bar. When the post-column pressure is satisfactory, add the post-column pressure to 1.5 bar and set this as the upper pressure limit on the chromatography system.

<sup>5</sup> Short term pH: pH interval where the medium can be subjected to cleaning- or sanitization-in-place without significant change in function.

Long term pH: pH interval where the medium can be operated without significant change in function.

<sup>6</sup> The strong chelator EDTA has been used successfully in some cases at 1 mM. Generally, chelating agents should be used with caution (and only in the sample, not in the buffer). Any metal-ion stripping may be counteracted by adding a small excess of MgCl<sub>2</sub> before centrifugation/filtration of the sample. Note that stripping effects may vary with the applied sample volume.



**Table A1.10.** Characteristics of HisPrep FF 16/10

Chromatography medium	Ni Sepharose 6 Fast Flow; see Table A1.1 for details
Column volume	20 mL
Column dimensions	1.6 × 10 cm
Dynamic binding capacity <sup>1</sup>	Approx. 40 mg histidine-tagged protein/mL medium
Recommended flow rate <sup>2</sup>	2–10 mL/min (60–300 cm/h)
Max. flow rate <sup>2</sup>	10 mL/min (300 cm/h)
Max. pressure over the packed bed during operation <sup>2</sup>	1.5 bar (0.15 MPa, 22 psi)
Column hardware pressure limit	5 bar (0.5 MPa, 73 psi)
Compatibility during use	Stable in all commonly used buffers, reducing agents, denaturing agents and detergents. See Table A1.2 for more information.
Chemical stability <sup>3</sup>	For 1 wk at 40°C: 0.01 M HCl, 0.1 M NaOH For 12 h: 1 M NaOH, 70% acetic acid 30 min tested: 30% 2-propanol 1 h tested: 2% SDS
Storage	20% ethanol
Storage temperature	4°C to 30°C

<sup>1</sup> Dynamic binding capacity conditions:

*Sample:* 1 mg/mL (histidine)<sub>6</sub>-tagged pure protein (M<sub>r</sub> 43 000) in binding buffer or (histidine)<sub>6</sub>-tagged protein (M<sub>r</sub> 28 000) bound from *E. coli* extract. Capacity determined at 10% breakthrough.

*Column volume:* 0.25 mL or 1 mL

*Flow rate:* 0.25 mL/min or 1 mL/min, respectively

*Binding buffer:* 20 mM sodium phosphate, 0.5 M NaCl, 5 mM imidazole, pH 7.4

*Elution buffer:* 20 mM sodium phosphate, 0.5 M NaCl, 500 mM imidazole, pH 7.4

Note: Dynamic binding capacity is protein dependent.

<sup>2</sup> H<sub>2</sub>O at room temperature.

<sup>3</sup> Ni<sup>2+</sup>-stripped medium.

**Table A1.11.** Characteristics of His Mag Sepharose Ni

Matrix	Highly cross-linked spherical agarose (Sepharose) including magnetite
Metal ion capacity	Approx. 21 μmol Ni <sup>2+</sup> /mL medium
Binding capacity <sup>1</sup>	Approx. 50 mg histidine-tagged protein/mL sedimented medium (~500 μg/purification run)
Particle size	37 to 100 μm
Working temperature	Room temperature and 4°C
Compatibility during use	Stable in all commonly used buffers, reducing agents, denaturants such as 6 M Gua-HCl and 8 M urea, and a range of other additives. See Table A1.2 for further information.
Storage solution	20% ethanol, 5% medium slurry
Storage temperature	Room temperature

<sup>1</sup> The capacity was determined using 5 mM imidazole in sample and binding buffer. Note that binding capacity is sample dependent.


# Stripping, recharging, and cleaning of Ni Sepharose products


## Stripping and recharging

Ni Sepharose High Performance and Ni Sepharose 6 Fast Flow do not have to be stripped and recharged between each purification if the same protein is to be purified. It may be sufficient to strip and recharge it after approximately two to five purifications, depending on the specific sample, sample pretreatment, sample volume, etc.


Stripping buffer: 20 mM sodium phosphate, 500 mM NaCl, 50 mM EDTA, pH 7.4

1. Strip the chromatography medium by washing with at least 5 to 10 column volumes of stripping buffer.
2. Wash with at least 5 to 10 column volumes of binding buffer; see Chapter 3.
3. Immediately wash with 5 to 10 column volumes of distilled water.
4. Recharge the water-washed column by loading 0.5 column volumes of 0.1 M NiSO<sub>4</sub> in distilled water onto the column.
5. Wash with 5 column volumes of distilled water, and 5 column volumes of binding buffer (to adjust pH) before storage in 20% ethanol. Salts of other metals, chlorides, or sulfates may also be used.

 It is important to wash with binding buffer as the last step to obtain the correct pH before storage.

 Washing with buffer before applying the metal ion solution may cause unwanted precipitation.

## Cleaning in place

 When an increase in back pressure is seen, the chromatography medium should be cleaned. Before cleaning, strip off metal ions using the recommended procedure described above. The stripped medium can be cleaned by the following methods:

### To remove ionically bound protein:


1. Wash with several column volumes of 1.5 M NaCl.
2. Immediately wash with approximately 10 column volumes of distilled water.

### To remove precipitated proteins, hydrophobically bound proteins, and lipoproteins:

1. Wash the column with 1 M NaOH, contact time usually 1 to 2 h (12 h or more for endotoxin removal).
2. Immediately wash with approximately 10 column volumes of binding buffer, followed by 5 to 10 column volumes of distilled water.

### To remove hydrophobically bound proteins, lipoproteins, and lipids:

1. Wash with 5 to 10 column volumes of 30% isopropanol for about 15 to 20 min.
2. Immediately wash with approximately 10 column volumes of distilled water.
- 2a. Alternatively, wash with 2 column volumes of detergent in a basic or acidic solution. Use, for example, 0.1 to 0.5% nonionic detergent in 0.1 M acetic acid, contact time 1 to 2 h. After treatment, always remove residual detergent by washing with at least 5 column volumes of 70% ethanol. Then wash with approximately 10 column volumes of distilled water.

 Reversed flow may improve the efficiency of the cleaning-in-place procedure. After cleaning, store in 20% ethanol (wash with 5 column volumes) or recharge with Ni<sup>2+</sup> prior to storage in ethanol.

## Ni Sepharose excel/His Mag Sepharose excel products

Ni Sepharose excel and His Mag Sepharose excel are designed for capture and purification of histidine-tagged proteins secreted into eukaryotic cell culture supernatants. Nickel ions are very strongly bound to both chromatography media, enabling direct loading of large sample volumes without removing agents that normally would cause metal ion stripping. His Mag Sepharose excel is magnetic beads designed for simple and efficient purification and screening. Ni Sepharose excel is available for all scales of work from convenient, prepacked HisTrap excel columns to bulk quantities.

Table A1.12 summarizes key characteristics of both media, and Table A1.13 lists the stability of Ni Sepharose excel under various conditions. Table A1.14 summarizes the characteristics of Ni Sepharose excel prepacked as a HisTrap excel column. For more information, refer to Chapter 3.

**Table A1.12.** Characteristics of His Mag Sepharose excel and Ni Sepharose excel

Product	His Mag Sepharose excel	Ni Sepharose excel
Matrix	Highly cross-linked spherical agarose including magnetite	Highly cross-linked spherical agarose
Precharged ion	Nickel	Nickel
Average particle size	63 $\mu\text{m}$	90 $\mu\text{m}$
Binding capacity <sup>1</sup>	At least 10 mg (histidine) <sub>6</sub> -tagged protein/mL sedimented medium	At least 10 mg (histidine) <sub>6</sub> -tagged protein/mL sedimented medium
Maximum flow velocity <sup>2,3</sup>	N/A	600 cm/h
pH stability <sup>4</sup>	Working range: 3 to 12 Cleaning in place: N/A	Working range: 3 to 12 Cleaning in place: 2 to 14
Storage	4°C to 30°C in 20% ethanol	4°C to 30°C in 20% ethanol

<sup>1</sup> Binding capacity is sample dependent.

<sup>2</sup> H<sub>2</sub>O at room temperature.

<sup>3</sup> Optimal flow velocity during binding is sample dependent. During column wash and elution, a flow velocity of 150 cm/h is recommended.

<sup>4</sup> Working range: pH interval where the medium can be operated without significant change in function. Cleaning in place: pH interval where the medium can be subjected to cleaning in place without significant change in function.

**Table A1.13.** Chemical stability<sup>1</sup> of Ni Sepharose excel

Substance	Duration of test
0.01 M HCl and 0.01 M NaOH	1 wk
10 mM EDTA, 1 M NaOH, 5 mM DTT, 5 mM TCEP, 20 mM $\beta$ -mercaptoethanol, and 6 M Gua-HCl	24 h
500 mM imidazole and 100 mM EDTA	2 h
30% 2-propanol	20 min

<sup>1</sup> Chemical stability was tested by incubating the medium in the listed solutions at room temperature, and thereafter measuring either the nickel leakage or the protein binding capacity.



**Table A1.14.** Main characteristics of HisTrap excel

Column	HisTrap excel
Medium	Ni Sepharose excel
Column volumes	1 mL and 5 mL
Column dimensions	0.7 × 2.5 cm (1 mL column) 1.6 × 2.5 cm (5 mL column)
Recommended flow rates <sup>1,2</sup>	1 to 4 mL/min (1 mL column) 5 to 20 mL/min (5 mL column)
Maximum flow rates <sup>1</sup>	4 mL/min (1 mL column) 20 mL/min (5 mL column)
Column hardware pressure limit	5 bar (0.5 MPa)

<sup>1</sup> H<sub>2</sub>O at room temperature. Maximum flow rate will be lower when using buffers or samples with high viscosity or when performing purification at low temperature.

<sup>2</sup> Optimal flow rate during binding is sample dependent. During column wash and elution, a flow rate of 1 mL/min and 5 mL/min is recommended for 1 mL and 5 mL columns, respectively.

Note: The maximum pressure the packed bed can withstand depends on the chromatography medium characteristics and sample/liquid viscosity. The value measured on the chromatography system used also depends on the tubing used to connect the column.

## Cleaning of Ni Sepharose excel products

The ligand is precharged with exceptionally strongly bound nickel ions. The nickel ions remain bound even after 24 h of incubation in 10 mM EDTA. **No nickel ion recharging is required after use.**

### Cleaning in place

 When an increase in back pressure is seen, the column should be cleaned. Different methods for cleaning-in-place (CIP) are described below.

 Do not exceed a flow velocity of 150 cm/h during CIP.

### To remove ionically bound proteins:

1. Wash with several column volumes of 1.5 M NaCl.
2. Wash with approximately 10 column volumes of distilled water or binding buffer; (20 mM sodium phosphate, 0.5 M NaCl, pH 7.4).

### To remove precipitated proteins, hydrophobically bound proteins, and lipoproteins:

1. Wash the column with 1 M NaOH, contact time usually 1 to 2 h (12 to 24 h for endotoxin removal).
2. Wash with approximately 10 column volumes of binding buffer.

### To remove hydrophobically bound proteins, lipoproteins, and lipids:

1. Wash with 5 to 10 column volumes of 30% isopropanol for about 15 to 20 min.
2. Wash with approximately 10 column volumes of distilled water or equilibration buffer.
- 2.a. Alternatively, wash with 2 column volumes of detergent in a basic or acidic solution. Use, for example, 0.1 to 0.5% nonionic detergent in 0.1 M acetic acid, contact time 1 to 2 h. Then remove residual detergent by washing with at least 5 column volumes of 70% ethanol. Last, wash with approximately 10 column volumes of equilibration buffer.

## TALON Superflow products

TALON Superflow is a cobalt-based immobilized metal ion affinity chromatography medium (IMAC) offering enhanced selectivity for histidine-tagged proteins compared with nickel-charged chromatography media. TALON Superflow is available for all scales of work from 96-well plates to convenient, prepacked columns to bulk quantities, enabling different throughput and scales from screening in low microgram scale to milligram preparative purification of histidine-tagged proteins.

Table A1.15 summarizes key characteristics of bulk TALON Superflow medium, and Table A1.16 lists the stability of the medium under various conditions. Tables A1.17 to A1.18 summarize the characteristics of these same media as prepacked columns and as prepacked 96-well plates. For more information, refer to Chapter 3.

**Table A1.15.** Characteristics of TALON Superflow

Matrix	Cross-linked agarose, 6%
Precharged ion	Cobalt
Particle size distribution	60 $\mu\text{m}$ to 160 $\mu\text{m}$
Binding capacity <sup>1</sup>	Up to 20 mg histidine-tagged protein/mL medium
Maximum flow velocity <sup>2</sup>	2000 cm/h
pH stability <sup>3,4</sup>	
Short term (2 h)	2 to 14
Long term (1 wk)	3 to 12
Storage	20% ethanol at 4°C to 8°C
Compatibility during use	Stable in all commonly used buffers, denaturants, and detergents (see Table A1.16)

<sup>1</sup> The binding capacity for individual proteins may vary.

<sup>2</sup> H<sub>2</sub>O in a 0.75 × 10 cm (i.d. × H) column.

<sup>3</sup> Co<sup>2+</sup>-stripped medium.

<sup>4</sup> Below pH 4, metal ions will be stripped off the medium, and therefore neutral to slightly alkaline pH (pH 7 to 8) is recommended.

**Table A1.16.** Compatible reagents for TALON Superflow<sup>1,2</sup>

Reagent	Acceptable concentration
β-Mercaptoethanol <sup>3</sup>	10 mM (with caution)
CHAPS, SDS, sarcosyl <sup>4</sup>	1% (with caution)
Ethanol <sup>5</sup>	30%
Ethylene glycol	30%
HEPES	50 mM
Glycerol	20%
Gua-HCl	6 M
Imidazole <sup>6</sup>	≤ 500 mM at pH 7.0 to 8.0, for elution
KCl	500 mM
MES	20 mM
MOPS	50 mM
NaCl	1.0 M
NP-40	1%
Tris <sup>7</sup>	50 mM
Tween-20	< 1%
Urea	8 M

<sup>1</sup> Data provided by Clontech Laboratories, Inc.

<sup>2</sup> EDTA and other chelators, such as EGTA, will strip Co<sup>2+</sup> ions from the medium; EDTA may be used, but must be removed prior to sample application. Strong reducing agents should also be avoided (e.g., DTT, DTE, and TCEP) because they interfere with Co<sup>2+</sup> ions binding to the medium.

<sup>3</sup> Use TALON Superflow immediately after equilibrating with buffers containing β-mercaptoethanol, otherwise the medium will change color. Do not store the medium in buffers containing β-mercaptoethanol.

<sup>4</sup> Ionic detergents like CHAPS, SDS, and sarcosyl are compatible up to 1%. However, due to their charged nature, you should anticipate interference with binding.

<sup>5</sup> Ethanol may precipitate proteins, causing low yields and column clogging.

<sup>6</sup> Imidazole at concentrations higher than 5 to 10 mM may cause lower yields of histidine-tagged proteins because it competes with the histidine side chains (imidazole groups) for binding to the immobilized metal ions.

<sup>7</sup> Tris coordinates weakly with metal ions, causing a decrease in capacity.

**Table A1.17.** Characteristics of His GraviTrap TALON, His SpinTrap TALON, and His MultiTrap TALON

Column and 96-well plate material	Polypropylene barrel and plate, polyethylene frits
Protein binding capacity <sup>1</sup>	
His GraviTrap TALON	Up to 15 mg histidine-tagged protein/column
His SpinTrap TALON	Up to 1 mg histidine-tagged protein/column
His MultiTrap TALON	Up to 1 mg histidine-tagged protein/well
Bed volume in columns/wells	
His GraviTrap TALON	1 mL/column
His SpinTrap TALON	100 μL/column
His MultiTrap TALON	50 μL/well (500 μL of 10% slurry)
Total volume in columns/wells	
His GraviTrap TALON	13.5 mL
His SpinTrap TALON	1000 μL
His MultiTrap TALON	800 μL
Reproducibility, His MultiTrap TALON, column-to-column, plate-to-plate, and well-to-well	±10%
Filter plate size of His MultiTrap TALON	127.8 × 85.5 × 30.6 mm according to ANSI/SBS 1-2004, 3-2004 and 4-2004 standards
Number of wells	96
Avoid in buffers	Chelating agents, e.g. EDTA, EGTA, citrate and DTT, DTE, and TCEP

<sup>1</sup> The binding capacity for individual proteins may vary.

**Table A1.18.** Characteristics of HiTrap TALON crude

Column volume	1 mL and 5 mL
Column dimensions, i.d. × H	0.7 × 2.5 cm (1 mL column) 1.6 × 2.5 cm (5 mL column)
Recommended flow rate <sup>1</sup>	1 mL/min (1 mL column) 5 mL/min (5 mL column)
Maximum flow rate <sup>1</sup>	4 mL/min (1 mL column) 20 mL/min (5 mL column)
Column hardware pressure limit <sup>2</sup>	0.5 MPa, 5 bar
Chromatography medium	TALON Superflow (see Table A1.15)

<sup>1</sup> H<sub>2</sub>O at room temperature.

<sup>2</sup> The pressure over the packed bed varies depending on a range of parameters such as the characteristics of the chromatography medium and the column tubing used.



## Stripping, recharging, and cleaning of TALON Superflow products

TALON Superflow and HiTrap TALON crude do not have to be stripped and recharged between each purification if the same protein is to be purified. It may be sufficient to strip and recharge it after approximately two to five purifications, depending on the specific sample, sample pretreatment, sample volume, etc.

Purification of histidine-tagged proteins using imidazole gradients will cause TALON Superflow to take on a dark purplish color. Washing the medium with 5 to 10 bed/column volumes of 20 mM MES Buffer (pH 5.0) will restore the normal pink color and bring the absorbance at 280 nm back to the original baseline level. After equilibrating with binding buffer (50 mM sodium phosphate, 300 mM NaCl, pH 7.4), the medium/column is ready for reuse.

### Stripping and recharging

Stripping buffer: 200 mM EDTA, pH 7.0

1. Strip the TALON Superflow/HiTrap TALON crude of cobalt ions by washing with 10 bed/column volumes of stripping buffer.
2. Wash excess EDTA from the medium with an additional 10 bed/column volumes of distilled water.
3. Charge the chromatography medium with 10 bed/column volumes of 50 mM  $\text{CoCl}_2$  solution.
4. Wash with 7 bed/column volumes of distilled water followed by 3 bed/column volumes of 300 mM NaCl and by 3 bed/column volumes of distilled water to remove excess cobalt metal ions.
5. Equilibrate with 10 bed/column volumes of binding buffer.



It is important to wash with binding buffer as the last step to obtain the correct pH before storage.

## Uncharged IMAC Sepharose products

IMAC Sepharose High Performance is recommended for high-resolution purifications, providing sharp peaks and concentrated eluate. IMAC Sepharose 6 Fast Flow is excellent for scaling up.

Table A1.19 summarizes key characteristics of IMAC Sepharose media, and Table A1.20 lists the stability of the media under various conditions. Tables A1.21 to A1.23 summarize the characteristics of the media as prepacked columns. For more information, refer to Chapter 3.

**Table A1.19.** Characteristics of IMAC Sepharose High Performance and IMAC Sepharose 6 Fast Flow

Characteristics	IMAC Sepharose High Performance	IMAC Sepharose 6 Fast Flow
Matrix	Highly cross-linked 6% spherical agarose	Highly cross-linked 6% spherical agarose
Metal ion capacity	Approx. 15 $\mu\text{mol Ni}^{2+}/\text{mL}$ medium	Approx. 15 $\mu\text{mol Ni}^{2+}/\text{mL}$ medium
Average particle size	34 $\mu\text{m}$	90 $\mu\text{m}$
Dynamic binding capacity <sup>1</sup>	At least 40 mg (histidine) <sub>6</sub> -tagged protein/mL medium ( $\text{Ni}^{2+}$ -charged)	Histidine-tagged protein: Approx. 40 mg (histidine) <sub>6</sub> -tagged protein/mL medium ( $\text{Ni}^{2+}$ -charged) Untagged protein: Approx. 25 mg/mL medium ( $\text{Cu}^{2+}$ -charged); approx. 15 mg/mL medium ( $\text{Zn}^{2+}$ or $\text{Ni}^{2+}$ -charged).
Recommended flow velocity <sup>2</sup>	< 150 cm/h	150 cm/h
Compatibility during use	Stable in all commonly used buffers, reducing agents, denaturing agents, and detergents. See Table A1.20 for more information.	Stable in all commonly used buffers, reducing agents, denaturing agents, and detergents. See Table A1.20 for more information.
Chemical stability <sup>3</sup>	For 1 wk at 40°C: 0.01 M HCl, 0.1 M NaOH For 12 h: 1 M NaOH, 70% acetic acid 1 h tested: 2% SDS 30 min tested: 30% 2-propanol	For 1 wk at 40°C: 0.01 M HCl, 0.1 M NaOH For 12 h: 1 M NaOH, 70% acetic acid 1 h tested: 2% SDS 30 min tested: 30% 2-propanol
pH stability <sup>3</sup>	Short term (< 2 h): 2–14 Long term (< 1 wk): 3–12	Short term (< 2 h): 2–14 Long term (< 1 wk): 3–12
Storage	20% ethanol	20% ethanol
Storage temperature	4°C to 30°C	4°C to 30°C

<sup>1</sup> Conditions for determining dynamic binding capacity:

**Samples:** (Histidine)<sub>6</sub>-tagged proteins: Capacity data were obtained for a protein ( $M_r$  28 000) bound from an *E. coli* extract, and a pure protein ( $M_r$  43 000) applied at 1 mg/mL in binding buffer; capacity at 10% breakthrough. Untagged protein (IMAC Sepharose 6 Fast Flow only): Capacities determined at 10% breakthrough for human apotransferrin applied at 1 mg/mL in binding buffer.

**Column volume:** 0.25 mL or 1 mL

**Flow rate:** 0.25 mL/min or 1 mL/min, respectively

**Binding buffer:** 20 mM sodium phosphate, 0.5 M NaCl, 5 mM imidazole (1 mM for untagged protein, IMAC Sepharose 6 Fast Flow only), pH 7.4

**Elution buffer:** 20 mM sodium phosphate, 0.5 M NaCl, 500 mM imidazole (50 mM for untagged protein, IMAC Sepharose 6 Fast Flow only), pH 7.4

Note: Dynamic binding capacity is metal ion and protein dependent.

<sup>2</sup> H<sub>2</sub>O at room temperature.

<sup>3</sup> Uncharged medium only. See Table A1.20 for more information.

**Table A1.20.** Compatibility guide: IMAC Sepharose High Performance and IMAC Sepharose 6 Fast Flow are stable toward these compounds at least at the concentrations given

Compound	Concentration
Reducing agents <sup>1</sup>	5 mM DTE
	5 mM DTT
	20 mM β-mercaptoethanol
	5 mM TCEP
	10 mM reduced glutathione
Denaturing agents	8 M urea <sup>2</sup>
	6 M Gua-HCl <sup>2</sup>
Detergents	2% Tween 20 (nonionic)
	2% NP-40 (nonionic)
	2% cholate (anionic)
	1% CHAPS (zwitterionic)
Other additives	500 mM imidazole
	20% ethanol
	50% glycerol
	100 mM Na <sub>2</sub> SO <sub>4</sub>
	1.5 M NaCl
	1 mM EDTA <sup>3</sup>
Buffers	60 mM citrate <sup>2</sup>
	50 mM sodium phosphate, pH 7.4
	100 mM Tris-HCl, pH 7.4
	100 mM Tris-acetate, pH 7.4
	100 mM HEPES, pH 7.4
100 mM MOPS, pH 7.4	
100 mM sodium acetate, pH 4 <sup>2</sup>	

<sup>1</sup> Before performing runs with sample/buffers containing reducing reagents, a blank run with binding and elution buffers excluding reducing agents is recommended (see, for example, *Blank run in Purification using IMAC Sepharose High Performance*, Chapter 3).

<sup>2</sup> Tested for 1 wk at 40°C.

<sup>3</sup> The strong chelator EDTA has been used successfully in some cases, at 1 mM. Generally, chelating agents should be used with caution (and only in the sample, not the buffer). Any metal-ion stripping may be counteracted by adding a small excess of MgCl<sub>2</sub> before centrifugation/filtration of the sample. Note that stripping effects may vary with the applied sample volume.

**Table A1.21.** Characteristics of HiTrap IMAC HP and HiTrap IMAC FF

Chromatography media	HiTrap IMAC HP: IMAC Sepharose High Performance HiTrap IMAC FF: IMAC Sepharose 6 Fast Flow
Column volume	1 mL or 5 mL
Dynamic binding capacity <sup>1</sup>	At least 40 mg histidine-tagged protein/mL medium when charged with Ni <sup>2+</sup> . For untagged proteins, HiTrap FF can bind approx. 25 mg/mL medium charged with Cu <sup>2+</sup> or approx. 15 mg/mL medium charged with Zn <sup>2+</sup> or Ni <sup>2+</sup> .
Column dimensions	0.7 × 2.5 cm (1 mL); 1.6 × 2.5 cm (5 mL)
Recommended flow rate	1 mL/min (1 mL); 5 mL/min (5 mL)
Max flow rate <sup>2</sup>	4 mL/min (1 mL); 20 mL/min (5 mL)
Max. back pressure <sup>2</sup>	0.3 MPa, 3 bar
pH stability <sup>3</sup>	2–14 (short term), 3–12 (long term)
Compatibility during use	Stable in all commonly used buffers, reducing agents, denaturants, and detergents. See Table A1.20 for more information.
Chemical stability <sup>3</sup>	For 1 wk at 40°C: 0.01 M HCl, 0.1 M NaOH For 12 h: 1 M NaOH, 70% acetic acid 30 min tested: 30% 2-propanol 1 h tested: 2% SDS
Storage	20% ethanol
Storage temperature	4°C to 30°C

<sup>1</sup> Conditions for determining dynamic binding capacity:

*Samples:* (Histidine)<sub>6</sub>-tagged proteins: Capacity data were obtained for a protein (M<sub>r</sub> 28 000) bound from an *E. coli* extract, and a pure protein (M<sub>r</sub> 43 000) applied at 1 mg/mL in binding buffer; capacity at 10% breakthrough. Untagged protein (IMAC Sepharose 6 Fast Flow only): Capacities determined at 10% breakthrough for human apotransferrin applied at 1 mg/mL in binding buffer.

*Column volume:* 0.25 mL or 1 mL

*Flow rate:* 0.25 mL/min or 1 mL/min, respectively

*Binding buffer:* 20 mM sodium phosphate, 0.5 M NaCl, 5 mM imidazole (1 mM for untagged protein, IMAC Sepharose 6 Fast Flow only), pH 7.4

*Elution buffer:* 20 mM sodium phosphate, 0.5 M NaCl, 500 mM imidazole (50 mM for untagged protein, IMAC Sepharose 6 Fast Flow only), pH 7.4.

Note: Dynamic binding capacity is metal ion and protein dependent.

<sup>2</sup> H<sub>2</sub>O at room temperature.

<sup>3</sup> Uncharged medium only. See Table A1.20 for more information.

**Table A1.22.** Characteristics of HiScreen IMAC FF

Medium	IMAC Sepharose 6 Fast Flow
Matrix	Highly cross-linked 6% agarose
Particle size, d <sub>50v</sub> <sup>1</sup>	90 μm
Dynamic binding capacity <sup>2</sup>	Approx. 40 mg (histidine) <sub>6</sub> -tagged protein/mL medium Untagged protein: Approx. 25 mg/mL medium (Cu <sup>2+</sup> charged), or approx. 15 mg/mL medium (Zn <sup>2+</sup> or Ni <sup>2+</sup> charged).
Metal ion capacity	Approx. 15 μmol Ni <sup>2+</sup> /mL medium
Recommended fluid velocity <sup>3</sup>	30 to 300 cm/h
Maximum fluid velocity <sup>3</sup>	600 cm/h
Maximum pressure over the packed bed during operation, Δp <sup>4</sup>	0.15 MPa, 1.5 bar, 22 psi
HiScreen column hardware pressure limit	0.5 MPa, 5 bar, 73 psi
pH stability <sup>5</sup> (for medium without metal ion)	
- short term (at least 2 h)	2–14
- long term (≤ 1 week)	3–12
Compatibility during use	See Table A1.20
Chemical stability ( <i>for medium without metal ion</i> )	Tested for 12 h: 1 M NaOH, 70% acetic acid Tested for 1 h: 2% SDS Tested for 30 min: 30% 2-propanol
Avoid in buffers	Chelating agents, e.g., EDTA, EGTA, citrate <sup>6</sup>
Storage	4°C to 30°C in 20% ethanol

<sup>1</sup> d<sub>50v</sub> is the average particle size of the cumulative volume distribution.

<sup>2</sup> Dynamic binding capacity conditions:

*Samples:* 1 mg/mL (histidine)<sub>6</sub>-tagged pure protein (M<sub>r</sub> 43 000) in binding buffer (QB, 10% determination) or (histidine)<sub>6</sub>-tagged protein (M<sub>r</sub> 28 000) bound from *E. coli* extract.

*Column volumes:* 0.25 or 1 mL

*Flow rates:* 0.25 or 1 mL/min, respectively

*Binding buffer:* 20 mM sodium phosphate, 500 mM NaCl, 5 mM imidazole, pH 7.4

*Elution buffer:* 20 mM sodium phosphate, 500 mM NaCl, 500 mM imidazole, pH 7.4

Note: Dynamic binding capacity is protein dependent.

<sup>3</sup> H<sub>2</sub>O at room temperature.

<sup>4</sup> Many chromatography systems are equipped with pressure gauges to measure the pressure at a particular point in the system, usually just after the pumps. The pressure measured here is the sum of the pre-column pressure, the pressure drop over the medium bed, and the post-column pressure. It is always higher than the pressure drop over the bed alone. We recommend keeping the pressure drop over the bed below 1.5 bar. Setting the upper limit of your pressure gauge to 1.5 bar will ensure the pump shuts down before the medium is overpressured. If necessary, post-column pressure of up to 3.5 bar can be added to the limit without exceeding the column hardware limit. To determine post-column pressure, proceed as follows:

To avoid breaking the column, the post-column pressure must never exceed 3.5 bar.

1. Connect a piece of tubing in place of the column.
2. Run the pump at the maximum flow you intend to use for chromatography. Use a buffer with the same viscosity as you intend to use for chromatography. *Note the back pressure as total pressure.*
3. Disconnect the tubing and run at the same flow rate used in step 2. *Note this back pressure as pre-column pressure.*
4. Calculate the post-column pressure as total pressure minus pre-column pressure. If the post-column pressure is higher than 3.5 bar, take steps to reduce it (shorten tubing, clear clogged tubing, or change flow restrictors), and perform steps 1 to 4 again until the post-column pressure is below 3.5 bar. When the post-column pressure is satisfactory, add the post-column pressure to 1.5 bar and set this as the upper pressure limit on the chromatography system.

<sup>5</sup> Short term pH: pH interval where the medium can be subjected to cleaning- or sanitization-in-place without significant change in function. Long term pH: pH interval where the medium can be operated without significant change in function.

<sup>6</sup> The strong chelator EDTA has been used successfully in some cases at 1 mM. Generally, chelating agents should be used with caution (and only in the sample, not in the buffer). Any metal-ion stripping may be counteracted by adding a small excess of MgCl<sub>2</sub> before centrifugation/filtration of the sample. Note that stripping effects may vary with the applied sample volume.



**Table A1.23.** Characteristics of HiPrep IMAC FF 16/10

Chromatography medium	IMAC Sepharose 6 Fast Flow
Column volume	20 mL
Column dimensions	1.6 × 10 cm
Dynamic binding capacity <sup>1</sup>	Approx. 40 mg histidine-tagged protein/mL medium when charged with Ni <sup>2+</sup> . For untagged proteins, HiTrap FF binds approx. 25 mg/mL medium charged with Cu <sup>2+</sup> or approx. 15 mg/mL medium charged with Zn <sup>2+</sup> or Ni <sup>2+</sup> .
Recommended flow rate <sup>2</sup>	2–10 mL/min (60–300 cm/h)
Max. flow rate <sup>2</sup>	10 mL/min (300 cm/h)
Max. pressure over the packed bed during operation <sup>2</sup>	0.15 MPa, 1.5 bar
Column hardware pressure limit	0.5 MPa, 5 bar
Compatibility during use	Stable in all commonly used buffers, reducing agents, denaturants, and detergents. See Table A1.20 for more information.
Chemical stability <sup>3</sup>	Tested for 1 wk at 40°C: 0.01 M HCl, 0.1 M NaOH Tested for 12 h: 1 M NaOH, 70% acetic acid Tested for 1 h: 2% SDS Tested for 30 min: 30% 2-propanol
Storage	20% ethanol
Storage temperature	4°C to 30°C

<sup>1</sup> Conditions for determining dynamic binding capacity:

**Samples:** (Histidine)<sub>6</sub>-tagged proteins: Capacity data were obtained for a protein (M<sub>r</sub> 28 000) bound from an *E. coli* extract, and a pure protein (M<sub>r</sub> 43 000) applied at 1 mg/mL in binding buffer; capacity at 10% breakthrough. Untagged protein: Capacities determined at 10% breakthrough for human apotransferrin applied at 1 mg/mL in binding buffer.

**Column volume:** 0.25 or 1 mL

**Flow rate:** 0.25 or 1 mL/min, respectively

**Binding buffer:** 20 mM sodium phosphate, 500 mM NaCl, 5 mM imidazole, (1 mM for untagged protein) pH 7.4

**Elution buffer:** 20 mM sodium phosphate, 500 mM NaCl, 500 mM imidazole, (50 mM for untagged protein) pH 7.4

Note: Dynamic binding capacity is metal ion and protein dependent.

<sup>2</sup> H<sub>2</sub>O at room temperature.

<sup>3</sup> Uncharged medium only. See Table A1.20 for more information.

## Stripping, recharging, and cleaning of IMAC Sepharose products

IMAC Sepharose High Performance and IMAC Sepharose 6 Fast Flow do not have to be stripped and recharged between each purification if the same protein is to be purified. It may be sufficient to strip and recharge medium after approximately two to five purifications, depending on the specific sample, sample pretreatment, sample volume, etc.

### Stripping and recharging

Stripping buffer: 20 mM sodium phosphate, 500 mM NaCl, 50 mM EDTA, pH 7.4

1. Strip the chromatography medium by washing with at least 5 to 10 column volumes of stripping buffer.
2. Wash with at least 5 to 10 column volumes of binding buffer; see *Blank run* in *Purification using IMAC Sepharose High Performance*, Chapter 3.
3. Immediately wash with 5 to 10 column volumes of distilled water.
4. Prepare a 0.1 M solution of the chosen metal ion in distilled water. Salts of chlorides, sulfates, etc., can be used: e.g., 0.1 M CuSO<sub>4</sub> or 0.1 M NiSO<sub>4</sub>.
5. Recharge the water-washed column by loading at least 0.5 column volume of 0.1 M metal ion/salt solution.
6. Wash with 5 column volumes of distilled water, and 5 column volumes of binding buffer (to adjust pH) before storing column in 20% ethanol.




It is important to wash with binding buffer as the last step to obtain the correct pH before storage.



Washing with buffer before applying the metal ion solution may cause unwanted precipitation.

### Cleaning in place

 When an increase in back pressure is seen, the chromatography medium should be cleaned. Before cleaning, strip off metal ions using the recommended procedure described above. The **stripped** medium can be cleaned by the following methods:

#### To remove ionically bound protein:

1. Wash with several column volumes of 1.5 to 2.0 M NaCl.
2. Immediately wash with approximately 3 to 10 column volumes of distilled water.

#### To remove precipitated proteins, hydrophobically bound proteins, and lipoproteins:

1. Wash the column with 1 M NaOH, contact time usually 1 to 2 h (12 h or more for endotoxin removal).
2. Immediately wash with approximately 10 column volumes of binding buffer, followed by 5 to 10 column volumes of distilled water.

#### To remove hydrophobically bound proteins, lipoproteins, and lipids:

1. Wash with 5 to 10 column volumes of 30% isopropanol for about 15 to 20 min.
2. Immediately wash with approximately 10 column volumes of distilled water.  
2a. Alternatively, wash with 2 column volumes of detergent in a basic or acidic solution. Use, for example, 0.1 to 0.5% nonionic detergent in 0.1 M acetic acid, contact time 1 to 2 h. After treatment, always remove residual detergent by washing with at least 5 column volumes of 70% ethanol. Then wash with approximately 10 column volumes of distilled water.

Reversed flow may improve the efficiency of the cleaning-in-place procedure. After cleaning, store column in 20% ethanol (wash with 5 column volumes) or recharge with metal ions prior to storing in ethanol.

## Appendix 2

### Characteristics of Glutathione Sepharose products

Glutathione Sepharose High Performance is recommended for high-resolution purification of GST-tagged proteins, providing sharp peaks and concentrated eluent. Glutathione Sepharose Fast Flow is excellent for scaling up. Glutathione Sepharose 4B has high capacity and is recommended for packing small columns and other formats including batch purifications.

Table A2.1 summarizes key characteristics of these three Glutathione Sepharose chromatography media, and Tables A2.2 to A2.6 summarize the characteristics of the same media preppacked in columns and as 96-well plates. For more information, refer to Chapter 5.

**Table A2.1.** Characteristics of Glutathione Sepharose High Performance, Glutathione Sepharose 4 Fast Flow, and Glutathione Sepharose 4B

Characteristics	Glutathione Sepharose High Performance	Glutathione Sepharose 4 Fast Flow	Glutathione Sepharose 4B
Matrix	Highly cross-linked 6% agarose	Highly cross-linked 4% agarose	4% agarose
Average particle size	34 $\mu\text{m}$	90 $\mu\text{m}$	90 $\mu\text{m}$
Ligand concentration	1.5–3.5 mg glutathione/mL medium (based on Gly)	120–320 $\mu\text{mol}$ glutathione/mL medium	200–400 $\mu\text{mol}$ glutathione/g washed and dried medium
Binding capacity <sup>1</sup>	> 7 mg recombinant glutathione S-transferase/mL medium	> 10 mg recombinant glutathione S-transferase/mL medium	> 25 mg horse liver GST/mL medium
Recommended flow velocity <sup>2</sup>	< 150 cm/h	50–300 cm/h	< 75 cm/h
Chemical stability	Stable to all commonly used aqueous buffers, e.g., 1 M acetate, pH 4.0 and 6 M Gua-HCl for 1 h at room temperature	Stable to all commonly used aqueous buffers, e.g., 1 M acetate, pH 4.0, and 6 M Gua-HCl for 1 h at room temperature	Stable to all commonly used aqueous buffers. Exposure to 0.1 M NaOH, 70% ethanol, or 6 M Gua-HCl for 2 h at room temperature or to 1% (w/v) SDS for 14 d causes no significant loss of activity.
pH stability	3–12	3–12	4–13
Storage temperature	4°C to 30°C	4°C to 30°C	4°C to 8°C
Storage buffer	20% ethanol	20% ethanol	20% ethanol

<sup>1</sup> The binding of GST-tagged proteins depends on size, conformation, and concentration of the protein in the sample loaded. Binding of GST to glutathione is also flow dependent, and lower flow rates often increase the binding capacity. This is important during sample loading. Protein characteristics, pH, and temperature, but also the media used may affect the binding capacity.

<sup>2</sup> H<sub>2</sub>O at room temperature.



**Table A2.2.** Characteristics of GST MultiTrap 4B

Chromatography media	GST MultiTrap 4B: Glutathione Sepharose 4B
Filter plate size <sup>1</sup>	127.8 × 85.5 × 30.6 mm
Filter plate material	Polypropylene and polyethylene
Binding capacity	GST MultiTrap 4B: Up to 0.5 mg GST-tagged protein/well
Reproducibility between wells <sup>2</sup>	+/- 10%
Volume packed medium/well	50 µL (500 µL of 10% slurry)
Number of wells	96
Centrifugation speed:	Depends on sample pretreatment and sample properties
recommended	100–500 × g
maximum	700 × g
Vacuum pressure:	Depends on sample pretreatment and sample properties
recommended	-0.1 to -0.3 bar
maximum	-0.5 bar
pH stability	Glutathione Sepharose 4B: 4–13
Storage	20% ethanol
Storage temperature	4°C to 8°C

<sup>1</sup> According to ANSI/SBS 1-2004, 3-2004, and 4-2004 standards (ANSI = American National Standards Institute and SBS = Society for Biomolecular Screening).

<sup>2</sup> The amount of eluted target proteins/well does not differ more than +/- 10% from the average amount/well for the entire filter plate.

**Table A2.3.** Characteristics of prepacked GSTrap HP, GSTrap FF, and GSTrap 4B columns

Characteristics	GSTrap HP	GSTrap FF	GSTrap 4B
Chromatography media	Glutathione Sepharose High Performance	Glutathione Sepharose 4 Fast Flow	Glutathione Sepharose 4B
Average particle size	34 µm	90 µm	90 µm
Dynamic binding capacity <sup>1,2</sup>	Approx. 7 mg rGST/mL medium	Approx. 10 mg rGST/mL medium	Approx. 25 mg horse liver GST/mL medium
Max. back-pressure <sup>3</sup>	0.3 MPa, 3 bar	0.3 MPa, 3 bar	0.3 MPa, 3 bar
Recommended flow rate <sup>3</sup>	Sample loading: 0.2–1 mL/min (1 mL) and 1–5 mL (5 mL). Washing and elution: 1–2 mL/min (1 mL) and 5–10 mL/min (5 mL).	Sample loading: 0.2–1 mL/min (1 mL) and 1–5 mL (5 mL). Washing and elution: 1–2 mL/min (1 mL) and 5–10 mL/min (5 mL).	Sample loading: 0.2–1 mL/min (1 mL) and 0.5–5 mL/min (5 mL). Washing and elution: 1 mL/min (1 mL) and 5 mL/min (5 mL).
Chemical stability	Stable to all commonly used aqueous buffers, e.g., 1 M acetate, pH 4.0 and 6 M Gua-HCl for 1 h at room temperature	Stable to all commonly used aqueous buffers, e.g., 1 M acetate, pH 6.0, and 6 M Gua-HCl for 1 h at room temperature	Stable to all commonly used aqueous buffers. Exposure to 0.1 M NaOH, 70% ethanol, or 6 M Gua-HCl for 2 h at room temperature or to 1% (w/v) SDS for 14 d causes no significant loss of activity.
pH stability	3–12	3–12	4–13
Storage temperature	4°C to 30°C	4°C to 30°C	4°C to 8°C
Storage buffer	20% ethanol	20% ethanol	20% ethanol

The column dimensions are identical for all three GSTrap columns (0.7 × 2.5 cm for the 1 mL column and 1.6 × 2.5 cm for the 5 mL column). Column volumes are 1 mL and 5 mL.

<sup>1</sup> The binding of GST-tagged proteins depends on size, conformation, and concentration of the protein in the sample loaded. Binding of GST to glutathione is also flow dependent, and lower flow rates often increase the binding capacity. This is important during sample loading. Protein characteristics, pH, and temperature, but also the chromatography medium used may affect the binding capacity.

<sup>2</sup> Dynamic binding capacity conditions (60% breakthrough):  
*Sample:* 1 mg/mL pure GST-tagged protein in binding buffer  
*Column volume:* 0.4 mL  
*Flow rate:* 0.2 mL/min (60 cm/h)  
*Binding buffer:* 10 mM sodium phosphate, 140 mM NaCl, 2.7 mM KCl, pH 7.4  
*Elution buffer:* 50 mM Tris-HCl, 10 mM reduced glutathione, pH 8.0

<sup>3</sup> H<sub>2</sub>O at room temperature.

**Table A2.4.** Characteristics of GSTPrep FF 16/10

Chromatography medium	Glutathione Sepharose 4 Fast Flow
Column volume	20 mL
Column dimensions	1.6 × 10 cm
Dynamic binding capacity <sup>1,2</sup>	Approx. 200 mg rGST/column
Recommended flow rate <sup>3</sup>	1–10 mL/min (30–300 cm/h)
Max. flow rate <sup>3</sup>	10 mL/min (300 cm/h)
Max. pressure over the packed bed during operation <sup>3</sup>	1.5 bar (0.15 MPa, 22 psi)
Column hardware pressure limit	5 bar (0.5 MPa, 73 psi)
Storage	20% ethanol
Storage temperature	4°C to 30°C

<sup>1</sup> The binding of GST-tagged proteins depends on size, conformation, and concentration of the protein in the sample loaded. Binding of GST to glutathione is also flow dependent, and lower flow rates often increase the binding capacity. This is important during sample loading. Protein characteristics, pH, and temperature, but also the chromatography medium used may affect the binding capacity.

<sup>2</sup> Dynamic binding capacity conditions (60% breakthrough):  
*Sample:* 1 mg/mL pure GST-tagged protein in binding buffer  
*Column volume:* 0.4 mL  
*Flow rate:* 0.2 mL/min (60 cm/h)  
*Binding buffer:* 10 mM sodium phosphate, 140 mM NaCl, 2.7 mM KCl, pH 7.4  
*Elution buffer:* 50 mM Tris-HCl, 10 mM reduced glutathione, pH 8.0

<sup>3</sup> H<sub>2</sub>O at room temperature.

**Table A2.5.** Characteristics of GST GraviTrap preppacked columns

Column material frits	Polypropylene barrel, polyethylene
Column volume	13 mL
Medium	Glutathione Sepharose 4B
Average bead size	45–165 $\mu\text{m}$
Ligand	Glutathione and 10-carbon linker arm
Ligand concentration	7–15 $\mu\text{mol}$ glutathione/mL medium
Protein binding capacity <sup>1</sup>	Approx. 50 mg horse liver GST/column
Bed volume	2 mL
Compatibility during use	All commonly used aqueous buffers
Chemical stability	No significant loss of the capacity is detected when Glutathione Sepharose 4B is exposed to 0.1 M citrate (pH 4.0), 0.1 M NaOH, 70% ethanol, or 6 M Gua-HCl <sup>2</sup> for 2 h at room temperature. No significant loss of binding capacity is observed after exposure to 1% SDS for 14 d.
Storage solution	20% ethanol
pH stability	4–13
Storage temperature	4°C to 30°C

Note: It is not recommended to autoclave the columns.

<sup>1</sup> Binding capacity is protein dependent. The binding of GST-tagged proteins depends on size, conformation, and concentration of the protein in the sample. Binding of GST to glutathione is also flow dependent, and lower flow rates often increase the binding capacity. This is important during sample loading. Protein characteristics, pH, and temperature may also affect the binding capacity.

<sup>2</sup> Exposing the sample to 6 M Gua-HCl will denature the GST-tag. It is therefore important to remove all Gua-HCl before use.

**Table A2.6.** Characteristics of GST SpinTrap columns

Column material	Polypropylene barrel, polyethylene frits
Column volume	900 $\mu\text{L}$
Medium	Glutathione Sepharose 4B
Average bead size	90 $\mu\text{m}$
Ligand	Glutathione and 10-carbon linker arm
Ligand concentration	7–15 $\mu\text{mol}$ glutathione/mL medium
Protein binding capacity <sup>1</sup>	Approx. 500 $\mu\text{g}$ horse liver GST/column
Bed volume	50 $\mu\text{L}$
Compatibility during use	All commonly used aqueous buffers
Chemical stability	No significant loss of the capacity is detected when Glutathione Sepharose 4B is exposed to 0.1 M citrate (pH 4.0), 0.1 M NaOH, 70% ethanol or 6 M Gua-HCl <sup>2</sup> for 2 h at room temperature. No significant loss of binding capacity is observed after exposure to 1% SDS for 14 d.
Storage solution	PBS and 0.05% Kathon CG/ICP Biocide
pH stability	4–13
Storage temperature	Room temperature

<sup>1</sup> Binding capacity is protein dependent. The binding of GST-tagged proteins depends on size, conformation, and concentration of the protein in the sample loaded. Binding of GST to glutathione is also flow dependent, and lower flow rates often increase the binding capacity. This is important during sample loading. Protein characteristics, pH, and temperature may also affect the binding capacity.

<sup>2</sup> Exposing the sample to 6 M Gua-HCl will denature the GST-tag. It is therefore important to remove all Gua-HCl before use.

## Appendix 3

### Characteristics of Dextrin Sepharose High Performance products

This robust, high-resolution chromatography medium is based on the 34 µm Sepharose High Performance matrix. Due to the small size of the beads, the MBP-tagged protein is eluted in a narrow peak, minimizing the need for further concentration steps. Purification is performed under physiological conditions, and mild elution using maltose preserves the activity of the target protein. These mild conditions may even allow purification of intact protein complexes. Dextrin Sepharose High Performance tolerates all commonly used aqueous buffers and is easily regenerated using 0.5 M sodium hydroxide (see later in this appendix).

Table A3.1 summarizes key characteristics of Dextrin Sepharose High Performance. Table A3.2 summarizes the characteristics of this chromatography medium in prepacked columns.

Details on regeneration of the medium and columns follow.

**Table A3.1.** Characteristics of Dextrin Sepharose High Performance

Matrix	Rigid, highly cross-linked 6% agarose
Average particle size	34 µm
Ligand	Dextrin
Dynamic binding capacity <sup>1</sup>	Approx. 7 mg MBP2*-paramyosin-δ-Sal/mL medium (M <sub>r</sub> ~70 000, multimer in solution) Approx. 16 mg MBP2*-β-galactosidase/mL medium (M <sub>r</sub> ~158 000, multimer in solution)
Recommended flow velocity <sup>2</sup>	≤ 150 cm/h
Maximum flow velocity <sup>2</sup>	< 300 cm/h
Maximum back pressure <sup>2</sup>	0.3 MPa, 3 bar
Chemical stability <sup>3</sup>	Stable in all commonly used aqueous buffers, 0.5 M NaOH (regeneration and cleaning)
pH stability, working range	> 7
short-term	2 to 13
Storage	2°C to 8°C in 20% ethanol

<sup>1</sup> Binding capacity is protein dependent.

<sup>2</sup> H<sub>2</sub>O at room temperature.

<sup>3</sup> The presence of reducing agents, e.g., 5 mM DTT, may decrease yield. Higher ionic strength does not decrease affinity because MBP binds to dextrin primarily by hydrogen binding. Agents that interfere with hydrogen binding, such as urea and Gua-HCl, are not recommended. The presence of 10% glycerol may decrease the yield, and 0.1% SDS completely eliminates the binding.



**Table A3.2.** Characteristics of MBPTrap HP

Chromatography medium	Dextrin Sepharose High Performance
Average particle size	34 µm
Dynamic binding capacity <sup>1</sup>	Approx. 7 mg MBP2*-paramyosin δ-Sal/mL medium (M <sub>r</sub> ~70 000, multimer in solution) Approx. 16 mg MBP2*-β galactosidase/mL medium (M <sub>r</sub> ~158 000, multimer in solution)
Column volume	1 mL or 5 mL
Column dimensions	0.7 × 2.5 cm (1 mL) 1.6 × 2.5 cm (5 mL)
Recommended flow rates	1 and 5 mL/min for 1 and 5 mL columns, respectively
Maximum flow rates	4 and 20 mL/min for 1 and 5 mL columns, respectively
Maximum back pressure <sup>2</sup>	0.3 MPa, 3 bar
Chemical stability <sup>3</sup>	Stable in all commonly used aqueous buffers
pH stability, working range	> 7
short-term	2–13
Storage	2°C to 8°C in 20% ethanol

<sup>1</sup> Binding capacity is protein dependent.


<sup>2</sup> H<sub>2</sub>O at room temperature.

<sup>3</sup> The presence of reducing agents, e.g., 5 mM DTT, may decrease yield. Higher ionic strength does not decrease affinity because MBP binds to dextrin primarily by hydrogen binding. Agents that interfere with hydrogen binding, such as urea and Gua-HCl, are not recommended. The presence of 10% glycerol may decrease the yield, and 0.1% SDS completely eliminates the binding.

## Cleaning of Dextrin Sepharose products

After purification, the medium should be regenerated as follows:

1. Regenerate the column with 3 column volumes of distilled water followed by 3 column volumes of 0.5 M NaOH and 3 column volumes of distilled water. For bulk Dextrin Sepharose HP medium, use a flow velocity of 75 to 150 cm/h. For MBPTrap columns, use 0.5 to 1.0 mL/min for the 1 mL columns or 2.5 to 5.0 mL/min for the 5 mL columns for NaOH, and 1 mL/min or 5 mL/min, respectively, for distilled water.
2. Re-equilibrate the column with 5 column volumes of binding buffer (20 mM Tris-HCl, 200 mM NaCl, 1 mM EDTA, pH 7.4) before starting the next purification.

 An alternative to the above regeneration is to replace 0.5 M NaOH with 0.1% SDS. Do not regenerate with 0.1% SDS in a cold-room since the SDS may precipitate.

 If P-1 pump is used, a maximum flow rate of 1 to 3 mL/min can be run on a MBPTrap HP 1 mL column.

## Appendix 4

### Characteristics of StrepTactin Sepharose High Performance products

This robust, high-resolution chromatography medium is based on the 34 µm Sepharose High Performance matrix. Due to the small size of the beads, *Strep*-tag II protein is eluted in a narrow peak, minimizing the need for further concentration steps.

Purification is performed under physiological conditions, and mild elution using desthiobiotin preserves the activity of the target protein. The mild conditions even allow purification of intact protein complexes.

Tables A4.1 summarizes key characteristics of StrepTactin Sepharose High Performance, Table A4.2 lists the compatibility of the chromatography medium with various additives, and Table A4.3 summarizes the characteristics of this medium in prepacked columns.

Details on regeneration of the medium and columns follow.

**Table A4.1.** Characteristics of StrepTactin Sepharose High Performance

Matrix	Rigid, highly cross-linked agarose
Average particle size	34 µm
Ligand	StrepTactin
Ligand concentration	Approx. 5 mg/mL medium
Dynamic binding capacity <sup>1</sup>	Approx. 6 mg <i>Strep</i> -tag II protein/mL medium
Max. flow velocity <sup>2</sup>	300 cm/h
Recommended flow velocity <sup>2</sup>	≤ 150 cm/h
Maximum back pressure <sup>2</sup>	0.3 MPa, 3 bar
Chemical stability	Stable in all commonly used buffers, 0.5 M NaOH (regeneration and cleaning), reducing agents and detergents (see Table A4.2)
pH, working range	> pH 7.0
Storage	2°C to 8°C in 20% ethanol

<sup>1</sup> Dynamic binding capacity (DBC) is defined as mg protein applied per mL chromatography medium at the point where the concentration of protein in the column effluent reaches a value of 10% of the concentration in the sample. DBC was tested here with GAPDH-*Strep*-tag II M<sub>r</sub> 37 400. Binding capacity is protein dependent.

<sup>2</sup> H<sub>2</sub>O at room temperature.

**Table A4.2.** Compatibility of StrepTactin Sepharose High Performance with different additives<sup>1</sup>

Additive <sup>2</sup>	Concentration
<b>Reduction agents</b>	
DTT	50 mM
β-mercaptoethanol	50 mM
<b>Non-ionic detergents</b>	
C8E4, Octyltetraoxyethylene	max. 0.88%
C10E5, Decylpentaoxyethylene	0.12%
C10E6	0.03%
C12E8	0.005%
C12E9, Dodecyl nonaoxyethylene (Thesit)	0.023%
Decyl-β-D-maltoside	0.35%
N-dodecyl-β-D-maltoside	0.007%
N-nonyl-β-D-glucopyranoside	0.2%
N-octyl-β-D-glucopyranoside	2.34%
Tween 20	2%
<b>Ionic detergents</b>	
N-lauryl-sarcosine	2%
8-HESO;N-octyl-2-hydroxy-ethylsulfoxide	1.32%
SDS	0.1%
<b>Zwitterionic detergents</b>	
CHAPS	0.1%
DDAO	0.034%
LDAO	0.13%

Others	
Ammonium sulfate	2 M
CaCl <sub>2</sub>	max. 1 M
EDTA	50 mM
Guanidine	max. 1 M
Glycerol	max. 25% <sup>3</sup>
Imidazole	500 mM <sup>4</sup>
MgCl <sub>2</sub>	1 M
Urea	max. 1 M
NaCl	5 M

<sup>1</sup> Data kindly provided by IBA GmbH, Germany, the manufacturer and IP owner of the *Strep-Tactin* ligand.

<sup>2</sup> The additives have been successfully tested for purifying GADPH-Strep-tag II with concentrations up to those listed. Higher concentrations may, however, be possible for reagents not marked with "max." Since binding depends on the sterical accessibility of *Strep*-tag II in the context of the particular protein, the possible concentration may deviate from the given value for other proteins.

<sup>3</sup> Yield may decrease.

<sup>4</sup> 500 mM imidazole in sample tested by Cytiva.

**Table A4.3.** Characteristics of StrepTrap HP

Chromatography medium	StrepTactin Sepharose High Performance
Average particle size	34 μm
Ligand concentration	Approx. 5 mg/mL medium
Dynamic binding capacity <sup>1</sup>	Approx. 6 mg <i>Strep</i> -tag II protein/mL medium
Column volume	1 mL or 5 mL
Column dimensions	0.7 × 2.5 cm (1 mL) 1.6 × 2.5 cm (5 mL)
Recommended flow rates	1 and 5 mL/min for 1 and 5 mL columns, respectively
Maximum flow rates	4 and 20 mL/min for 1 and 5 mL columns, respectively
Maximum back pressure <sup>2</sup>	0.3 MPa, 3 bar
Chemical stability	Stable in all commonly used buffers, reducing agents, and detergents (see Table A4.2)
pH, working range	> pH 7.0
Storage	2°C to 8°C in 20% ethanol

<sup>1</sup> Binding capacity is protein to protein dependent. Dynamic binding capacity (DBC) was tested here with GADPH-*Strep*-tag II, M<sub>r</sub> 37 400.


<sup>2</sup> H<sub>2</sub>O at room temperature.



## Regeneration and cleaning of StrepTactin Sepharose High Performance


Recommended flow velocity is 75 - 150 cm/h.


1. Regenerate and clean the column with 3 column volumes of distilled water followed by 3 column volumes of 0.5 M NaOH and 3 column volumes of distilled water.
2. Re-equilibrate the column with 5 column volumes of binding buffer (100 mM Tris-HCl, 150 mM NaCl, 1 mM EDTA, pH 8 or PBS [20 mM sodium phosphate, 280 mM NaCl, 6 mM potassium chloride], pH 7.4) before starting the next purification.

 An alternative to the above regeneration/re-equilibration is 15 column volumes of 1 mM HABA (2-[4'-hydroxy-benzeneazo] benzoic acid) in binding buffer followed by 30 column volumes of binding buffer. The displacement is detected by the change in color of the medium in the column from yellow to red. This color change is due to the accumulation of HABA/StrepTactin complexes. The HABA is washed away with the binding buffer.

## Regeneration and cleaning of StrepTrap HP 1 mL and 5 mL

1. Regenerate the column with 3 column volumes of distilled water followed by 3 column volumes of 0.5 M NaOH and 3 column volumes of distilled water. Use a flow rate of 0.5 to 1 mL/min or 2.5 to 5 mL/min for 1 mL and 5 mL columns, respectively, with NaOH, and 1 mL/min or 5 mL/min, respectively, for distilled water.
2. Re-equilibrate the column with 5 column volumes of binding buffer before starting the next purification.

 An alternative to the above regeneration/re-equilibration is 15 column volumes of 1 mM HABA (2-[4'-hydroxy-benzeneazo] benzoic acid) in binding buffer followed by 30 column volumes of binding buffer. Use a flow rate of 2 mL/min or 10 mL/min for 1 mL and 5 mL columns, respectively. The displacement is detected by the change in color of the medium in the column from yellow to red. This color change is due to the accumulation of HABA/StrepTactin complexes. The HABA is washed away with the binding buffer.

 If P-1 pump is used, a maximum flow rate of 1 to 3 mL/min can be run on a HiTrap 1 mL column packed with Sepharose High Performance.

## Appendix 5


### Precipitation and resolubilization


Specific sample preparation steps may be required if the crude sample is known to contain contaminants such as lipids, lipoproteins, or phenol red that may build up on a column or if certain gross impurities, such as bulk protein, should be removed before any chromatographic step.

### Fractional precipitation

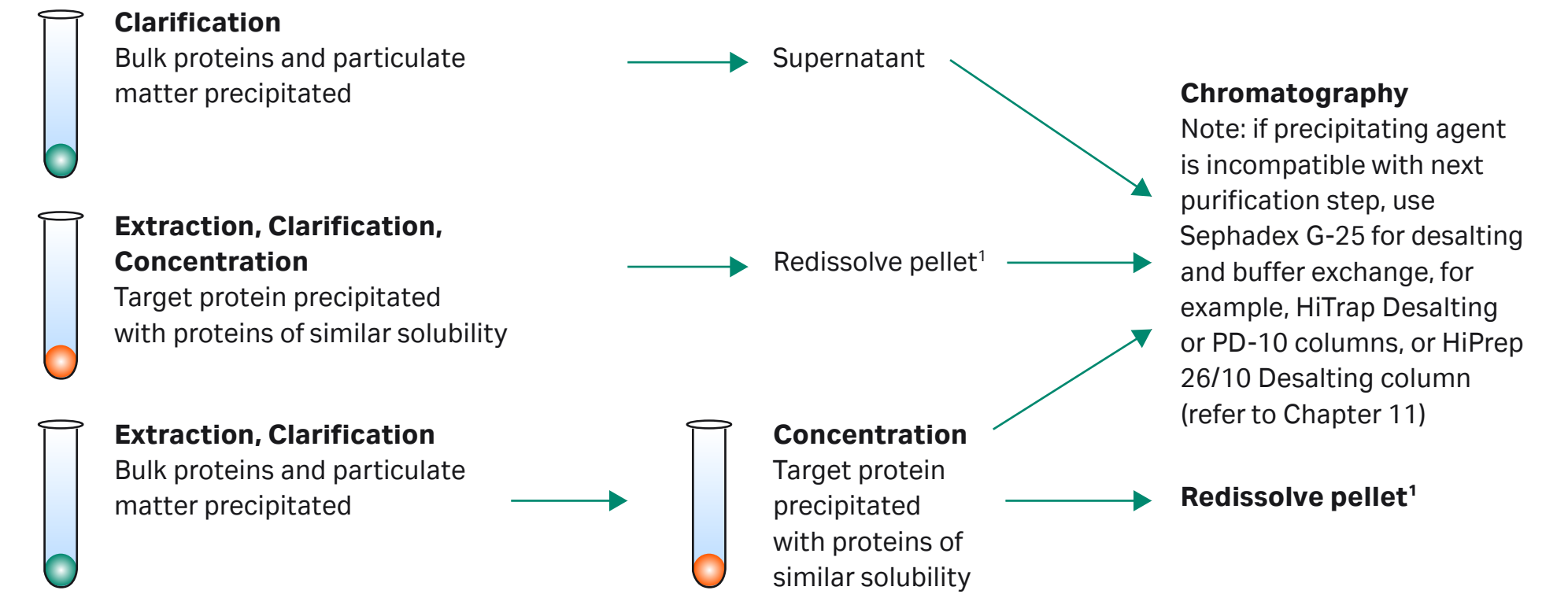
Fractional precipitation is occasionally used at laboratory scale to remove gross impurities but is generally not required in purification of affinity-tagged proteins. In some cases, though, precipitation can be useful as a combined protein concentration and purification step.

Precipitation techniques separate fractions by the principle of differential solubility. For example, because protein species differ in their degree of hydrophobicity, increased salt concentrations can enhance hydrophobic interactions between the proteins and cause precipitation. Fractional precipitation can be applied to remove gross impurities in three different ways, as shown in Figure A5.1.

 Precipitation techniques may be affected by temperature, pH, and sample concentration. These parameters must be controlled to ensure reproducible results.

 Most precipitation techniques are not suitable for large-scale preparation.

Examples of precipitation agents are reviewed in Table A5.1. The most common precipitation method using ammonium sulfate is described in more detail starting on the next page.



<sup>1</sup> Remember: not all proteins are easy to redissolve, yield can be reduced

**Fig A5.1.** Three ways to use precipitation.

**Table A5.1.** Examples of precipitation techniques

Precipitation agent	Typical conditions for use	Sample type	Comment
Ammonium sulfate	As described below.	> 1 mg/mL proteins, especially immunoglobulins.	Stabilizes proteins, no denaturation; supernatant can go directly to HIC. Helps to reduce lipid content.
Dextran sulfate	Add 0.04 mL of 10% dextran sulfate and 1 mL of 1 M CaCl <sub>2</sub> per mL of sample, mix 15 min, centrifuge at 10 000 × g, discard pellet.	Samples with high levels of lipoprotein, e.g., ascites.	Precipitates lipoprotein.
Polyvinylpyrrolidone	Add 3% (w/v), stir 4 h, centrifuge at 17 000 × g, discard pellet.	Samples with high levels of lipoprotein, e.g., ascites.	Alternative to dextran sulfate.
Polyethylene glycol (PEG, M <sub>r</sub> > 4000)	Up to 20% (w/v)	Plasma proteins.	No denaturation, supernatant goes directly to IEX or AC, complete removal may be difficult. Stabilizes proteins.
Acetone (cold)	Up to 80% (v/v) at 0°C. Collect pellet after centrifugation at full speed in a microcentrifuge.		May denature protein irreversibly. Useful for peptide precipitation or concentration of sample for electrophoresis.
Polyethyleneimine	0.1% (w/v)		Precipitates aggregated nucleoproteins.
Protamine sulfate	1% (w/v)		Precipitates aggregated nucleoproteins.
Streptomycin sulfate	1% (w/v)		Precipitates nucleic acids.
Caprylic acid	(X/15) g where X = volume of sample.	Antibody concentration should be > 1 mg/mL.	Precipitates bulk of proteins from sera or ascites, leaving immunoglobulins in solution.

Details taken from: *Scopes R.K., Protein Purification, Principles and Practice, Springer, (1994), J.C. Janson and L. Rydén, Protein Purification, Principles, High Resolution Methods and Applications, 2nd ed. Wiley Inc, (1998).*

## Ammonium sulfate precipitation

Ammonium sulfate precipitation is frequently used for initial sample concentration and cleanup. As the concentration of the salt is increased, proteins will begin to “salt out.” Different proteins salt out at different concentrations, a process that can be taken advantage of to remove contaminating proteins from the crude extract. The salt concentration needs to be optimized to remove contaminants and not the desired protein. An additional step with increased salt concentration should then precipitate the target protein. If the target protein cannot be safely precipitated and redissolved, only the first step should be employed. HIC is often an excellent next purification step, as the sample already contains a high salt concentration and can be applied directly to the HIC column with little or no additional preparation. The elevated salt level enhances the interaction between the hydrophobic components of the sample and the chromatography medium.




### Solutions needed for precipitation:


Saturated ammonium sulfate solution (add 100 g ammonium sulfate to 100 mL distilled water, stir to dissolve).

1 M Tris-HCl, pH 8.0.

Buffer for first purification step.


 Some proteins may be damaged by ammonium sulfate. Take care when adding crystalline ammonium sulfate: high local concentrations may cause contamination of the precipitate with unwanted proteins.

 It may be practical to use HIC as a second step after an initial ammonium sulfate precipitation.

 For routine, reproducible purification, precipitation with ammonium sulfate should be avoided in favor of chromatography.

 In general, precipitation is rarely effective for protein concentrations below 1 mg/mL.

1. Filter (0.45  $\mu\text{m}$ ) or centrifuge the sample (10 000  $\times$  g at 4°C).
2. Add 1 part 1 M Tris-HCl, pH 8.0 to 10 parts sample volume to maintain pH.
3. Stir gently. Add ammonium sulfate solution, drop by drop. Add up to 50% saturation. Stir for 1 h.

 The % saturation can be adjusted either to precipitate a target molecule or to precipitate contaminants. Depending on the material being precipitated, target or contaminants, either the pellet or the supernatant will need to be retained from step 5. Whether step 6 is required also depends on this. The remainder of this protocol assumes that the target protein is being precipitated.

4. Centrifuge 20 min at 10 000  $\times$  g.
5. Remove supernatant. Wash the pellet twice by resuspension in an equal volume of ammonium sulfate solution of the same concentration (i.e., a solution that will not redissolve the precipitated protein or cause further precipitation). Centrifuge again.
6. Dissolve pellet in a small volume of the buffer to be used for the next step.
7. Ammonium sulfate is removed during clarification/buffer exchange steps with Sephadex G-25, using desalting columns (see Chapter 11).

The quantity of ammonium sulfate required to reach a given degree of saturation varies according to temperature. Table A5.2 shows the quantities required at 20°C.

**Table A5.2.** Quantities of ammonium sulfate required to reach given degrees of saturation at 20°C


	Final percent saturation to be obtained																
	20	25	30	35	40	45	50	55	60	65	70	75	80	85	90	95	100
Starting percent saturation	Amount of ammonium sulfate to add (grams) per liter of solution at 20°C																
0	113	144	176	208	242	277	314	351	390	430	472	516	561	608	657	708	761
5	85	115	146	179	212	246	282	319	358	397	439	481	526	572	621	671	723
10	57	86	117	149	182	216	251	287	325	364	405	447	491	537	584	634	685
15	28	58	88	119	151	185	219	255	293	331	371	413	456	501	548	596	647
20	0	29	59	89	121	154	188	223	260	298	337	378	421	465	511	559	609
25		0	29	60	91	123	157	191	228	265	304	344	386	429	475	522	571
30			0	30	61	92	125	160	195	232	270	309	351	393	438	485	533
35				0	30	62	94	128	163	199	236	275	316	358	402	447	495
40					0	31	63	96	130	166	202	241	281	322	365	410	457
45						0	31	64	98	132	169	206	245	286	329	373	419
50							0	32	65	99	135	172	210	250	292	335	381
55								0	33	66	101	138	175	215	256	298	343
60									0	33	67	103	140	179	219	261	305
65										0	34	69	105	143	183	224	267
70											0	34	70	107	146	186	228
75												0	35	72	110	149	190
80													0	36	73	112	152
85														0	37	75	114
90															0	37	76
95																0	38



## Appendix 6

### Column packing and preparation

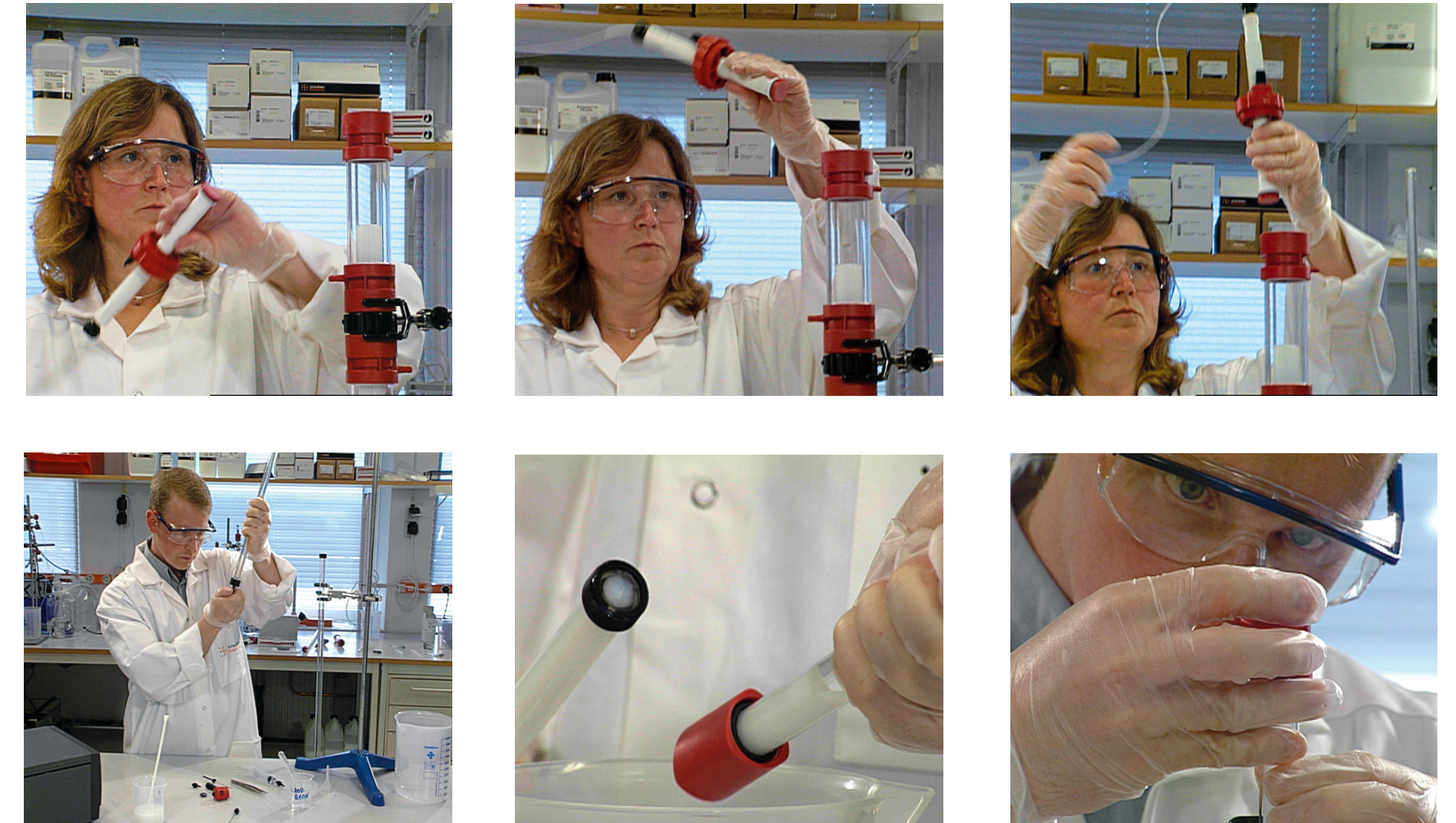
Prepacked columns from Cytiva will ensure reproducible results and the highest performance.

 Use small prepacked columns for chromatography media scouting and method optimization and to increase efficiency in method development.

Efficient column packing is essential for AC separation, especially when using gradient elution. A poorly packed column gives rise to poor and uneven flow, band broadening, and loss of resolution. If column packing is required, the following guidelines will apply at all scales of operation:

- With a high binding capacity medium, use short, wide columns (typically 5 to 15 cm bed height) for rapid purification, even at low flow velocity
- The amount of AC medium required will depend on the binding capacity of the medium and the amount of sample. Binding capacities for each medium are given in this handbook and supplied with the product instructions. Estimate the amount of medium required to bind the sample of interest and use five times this amount to pack the column. The amount of medium required can be reduced if resolution is satisfactory
- Once separation parameters have been determined, scale up a purification by increasing the diameter of the column to increase column volume. Avoid increasing the length of the column, if possible, as this will alter separation conditions

AC media can be packed in either Tricorn, XK, or HiScale columns available from Cytiva (Fig A6.1).




**Fig A6.1.** Column packing in progress.




1. Equilibrate all materials to the temperature at which the separation will be performed.
2. Eliminate air by flushing column end pieces with the recommended buffer. Ensure no air is trapped under the column net. Close column outlet leaving 1 to 2 cm of buffer in the column.
3. Gently resuspend the medium.

Note that AC media from Cytiva are supplied ready to use. Decanting of fines that could clog the column is unnecessary.


 Avoid using magnetic stirrers since they can damage the chromatography matrix.

4. Estimate the amount of slurry (resuspended medium) required on the basis of the recommendations supplied in the instruction manual.
5. Pour the required volume of slurry into the column. Pouring down a glass rod held against the wall of the column will minimize the introduction of air bubbles.
6. Immediately fill the column with buffer.
7. Mount the column top piece/adaptor and connect to a pump.
8. Open the column outlet and set the pump to the desired flow rate (for example, 15 mL/min in an XK 16/20 column).


 When slurry volume is greater than the total volume of the column, connect a second glass column to act as a reservoir (see *Ordering information* for details). This ensures that the slurry has a constant diameter during packing, minimizing turbulence and improving column packing conditions.


 If the recommended flow rate cannot be obtained, use the maximum flow rate the pump can deliver.

9. Maintain the packing flow rate for at least 3 CV after a constant bed height is obtained. Mark the bed height on the column.

 Do not exceed 70% of the packing flow rate during any purification.

10. Stop the pump and close the column outlet. If a second column has been used: Remove the top piece and carefully fill the rest of the column with buffer to form an upward meniscus at the top. Insert the adaptor into the column at an angle, ensuring that no air is trapped under the net.
11. Slide the adaptor slowly down the column (the outlet of the adaptor should be open) until the mark is reached. Lock the adaptor in position.
12. Connect the column to the pump and begin equilibration. Reposition the adaptor if necessary.

 The medium must be thoroughly washed to remove the storage solution, usually 20% ethanol. Residual ethanol can interfere with subsequent procedures.

 Many chromatography media equilibrated with sterile phosphate-buffered saline containing an antimicrobial agent may be stored at 4°C for up to 1 mo, but always follow the specific storage instructions supplied with the product.

## Column packing and efficiency

Column efficiency is expressed as the number of theoretical plates per meter chromatography bed (N) or as H (height equivalent to a theoretical plate, HETP), which is the bed length (L) divided by the plate number. Column efficiency is related to the band broadening that can occur on a column and can be calculated from the expression:

$$N = 5.54 \times \left( \frac{V_R}{W_h} \right)^2$$

$V_R$  = volume eluted from the start of sample application to the peak maximum

$W_h$  = peak width measured as the width of the recorded peak at half of the peak height

H is calculated from the expression:

$$H = \frac{L}{N}$$

L = height of packed bed.

☞ Measurements of  $V_R$  and  $W_h$  can be made in distance (mm) or volume (mL) but both parameters must be expressed in the same unit.

Column performance should be checked at regular intervals by injecting acetone to determine column efficiency (N) and peak symmetry (asymmetry factor,  $A_s$ ). Since the observed value for N depends on experimental factors such as flow rate and sample loading, comparisons must be made under identical conditions. In AC, efficiency is measured under isocratic conditions by injecting acetone (which does not interact with the medium) and measuring the eluted peak as shown in Figure A6.2.

As a general rule, a good H value is about two to three times the average particle diameter of the medium being packed. For a 90  $\mu\text{m}$  particle, this means an H value of 0.018 to 0.027 cm.

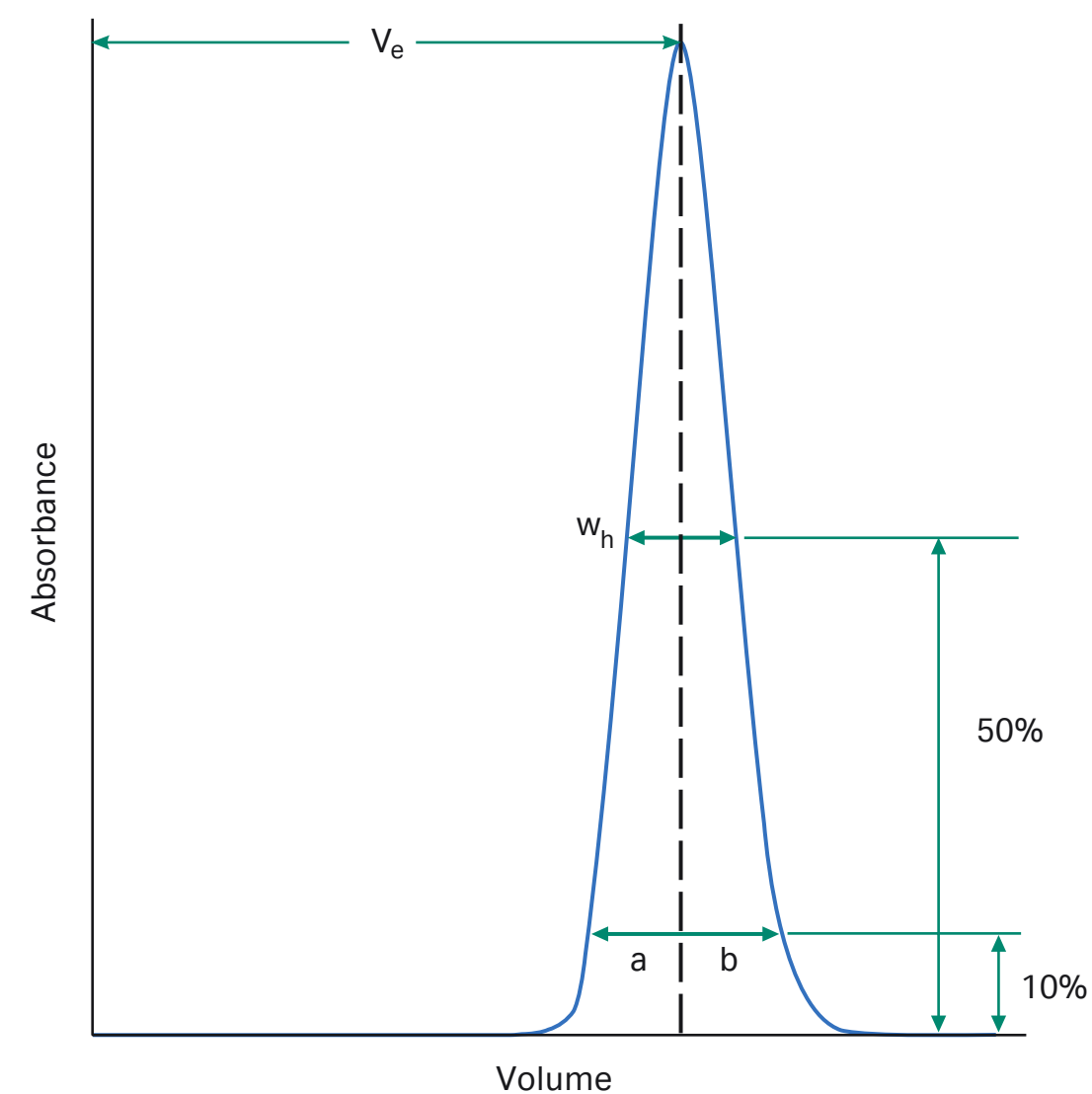


Fig A6.2. Measurements taken to calculate column efficiency.

The asymmetry factor ( $A_s$ ) is expressed as:

$$A_s = \frac{b}{a}$$

where

a = First half peak width at 10% of peak height

b = Second half peak width at 10% of peak height

$A_s$  should be as close as possible to 1.0. A reasonable  $A_s$  value for a short column as used in AC is 0.80 to 1.80.

☞ An extensive leading edge is usually a sign that the medium is packed too tightly and extensive tailing is usually a sign that the medium is packed too loosely.

☞ Run at least 2 CV of buffer through a newly packed column to ensure that the medium is equilibrated with start buffer. Use pH monitoring to check the pH of the eluent.

### Custom column packing

A service for packing of laboratory columns or filling of 96-well plates is supplied when columns or plates with suitable chromatography media are not available from the standard portfolio. The Custom Products group works in close collaboration with you to deliver packed columns for specialized purification requirements.

Visit [www.cytiva.com/custom-column-packing](http://www.cytiva.com/custom-column-packing) for more information.

## Appendix 7

### Conversion data

#### Proteins

##### Protein size and amount conversion

Mass (g/mol)	1 µg protein	1 nmol protein
10 000	100 pmol; $6 \times 10^{13}$ molecules	10 µg
50 000	20 pmol; $1.2 \times 10^{13}$ molecules	50 µg
100 000	10 pmol; $6.0 \times 10^{12}$ molecules	100 µg
150 000	6.7 pmol; $4.0 \times 10^{12}$ molecules	150 µg

##### Absorbance coefficient for proteins

Protein	$A_{280}$ for 1 mg/mL
IgG	1.35
IgM	1.20
IgA	1.30
Protein A	0.17
Avidin	1.50
Streptavidin	3.40
Bovine Serum Albumin	0.70

#### Column pressures

The maximum operating back pressure refers to the pressure above which the column contents may begin to compress.

Pressure units may be expressed in megaPascal (MPa), bar, or pounds per square inch (psi) and can be converted as follows: 1 MPa = 10 bar = 145 psi.



## Appendix 8

### Converting from flow velocity to volumetric flow rates

It is convenient when comparing results for columns of different sizes to express flow as flow velocity (cm/h). However, flow is usually measured in volumetric flow rate (mL/min). To convert between flow velocity and volumetric flow rate use one of the formulae below.

#### From flow velocity (cm/h) to volumetric flow rate (mL/min)

$$\begin{aligned}\text{Volumetric flow rate (mL/min)} &= \frac{\text{Flow velocity (cm/h)}}{60} \times \text{column cross sectional area (cm}^2\text{)} \\ &= \frac{Y}{60} \times \frac{\pi \times d^2}{4}\end{aligned}$$

where

Y = flow velocity in cm/h

d = column inner diameter in cm

*Example:*

What is the volumetric flow rate in an XK 16/70 column (i.d. 1.6 cm) when the flow velocity is 150 cm/h?

Y = flow velocity = 150 cm/h

d = inner diameter of the column = 1.6 cm

$$\begin{aligned}\text{Volumetric flow rate} &= \frac{150 \times \pi \times 1.6 \times 1.6}{60 \times 4} \text{ mL/min} \\ &= 5.03 \text{ mL/min}\end{aligned}$$

#### From volumetric flow rate (mL/min) to flow velocity (cm/h)

$$\begin{aligned}\text{Flow velocity (cm/h)} &= \frac{\text{Volumetric flow rate (mL/min)} \times 60}{\text{column cross sectional area (cm}^2\text{)}} \\ &= Z \times 60 \times \frac{4}{\pi \times d^2}\end{aligned}$$

where

Z = volumetric flow rate in mL/min

d = column inner diameter in cm

*Example:*

What is the linear flow in a Tricorn 5/50 column (i.d. 0.5 cm) when the volumetric flow rate is 1 mL/min?

Z = volumetric flow rate = 1 mL/min

d = column inner diameter = 0.5 cm

$$\text{Flow velocity} = 1 \times 60 \times \frac{4}{\pi \times 0.5 \times 0.5} \text{ cm/h}$$

#### From volumetric flow rate (mL/min) to using a syringe

1 mL/min = approximately 30 drops/min on a HiTrap 1 mL column

5 mL/min = approximately 120 drops/min on a HiTrap 5 mL column

# Appendix 9

## GST vectors

### pGEX-1T

Thrombin  
 Leu Val Pro Arg↓Gly Ser Pro Glu Phe Ile Val Thr Asp  
 CTG GTT CCG CGT GGA TCC CCG GAA TTC ATC GTG ACT GAC TGA CGA  
 BamHI EcoRI Stop codons

### pGEX-2T

Thrombin  
 Leu Val Pro Arg↓Gly Ser Pro Gly Ile His Arg Asp  
 CTG GTT CCG CGT GGA TCC CCG GGA ATT CAT CGT GAC TGA CTG ACG  
 BamHI SmaI EcoRI Stop codons

### pGEX-2TK

Thrombin Kinase  
 Leu Val Pro Arg↓Gly Ser Arg Arg Ala Ser Val  
 CTG GTT CCG CGT GGA TCT CGT CGT GCA TCT GTT GGA TCC CCG GGA ATT CAT CGT GAC TGA  
 BamHI SmaI EcoRI Stop codons

### pGEX-4T-1

Thrombin  
 Leu Val Pro Arg↓Gly Ser Pro Glu Phe Pro Gly Arg Leu Glu Arg Pro His Arg Asp  
 CTG GTT CCG CGT GGA TCC CCG GAA TTC CCG GGT CGA CTC GAG CCG CCG CAT CGT GAC TGA  
 BamHI EcoRI SmaI Sall XhoI NotI Stop codons

### pGEX-4T-2

Thrombin  
 Leu Val Pro Arg↓Gly Ser Pro Gly Ile Pro Gly Ser Thr Arg Ala Ala Ala Ser  
 CTG GTT CCG CGT GGA TCC CCA GGA ATT CCC GGG TCG ACT CGA GCG GCC GCA TCG TGA  
 BamHI EcoRI SmaI Sall XhoI NotI Stop codon

### pGEX-4T-3

Thrombin  
 Leu Val Pro Arg↓Gly Ser Pro Asn Ser Arg Val Asp Ser Ser Gly Arg Ile Val Thr Asp  
 CTG GTT CCG CGT GGA TCC CCG AAT TCC CGG GTC GAC TCG AGC GGC CGC ATC GTG ACT GAC TGA  
 BamHI EcoRI SmaI Sall XhoI NotI Stop codons

### pGEX-3X

Factor Xa  
 Ile Glu Gly Arg↓Gly Ile Pro Gly Asn Ser Ser  
 ATC GAA GGT CGT GGG ATC CCC GGG AAT TCA TCG TGA CTG ACT GAC  
 BamHI SmaI EcoRI Stop codons

### pGEX-5X-1

Factor Xa  
 Ile Glu Gly Arg↓Gly Ile Pro Glu Phe Pro Gly Arg Leu Glu Arg Pro His Arg Asp  
 ATC GAA GGT CGT GGG ATC CCC GAA TTC CCG GGT CGA CTC GAG CCG CCG CAT CGT GAC TGA  
 BamHI EcoRI SmaI Sall XhoI NotI Stop codons

### pGEX-5X-2

Factor Xa  
 Ile Glu Gly Arg↓Gly Ile Pro Gly Ile Pro Gly Ser Thr Arg Ala Ala Ala Ser  
 ATC GAA GGT CGT GGG ATC CCC GGA ATT CCC GGG TCG ACT CGA GCG GCC GCA TCG TGA  
 BamHI EcoRI SmaI Sall XhoI NotI Stop codon

### pGEX-5X-3

Factor Xa  
 Ile Glu Gly Arg↓Gly Ile Pro Arg Asn Ser Arg Val Asp Ser Ser Gly Arg Ile Val Thr Asp  
 ATC GAA GGT CGT GGG ATC CCC AGG AAT TCC CGG GTC GAC TCG AGC GGC CGC ATC GTG ACT GAC TGA  
 BamHI EcoRI SmaI Sall XhoI NotI Stop codons

### pGEX-6P-1

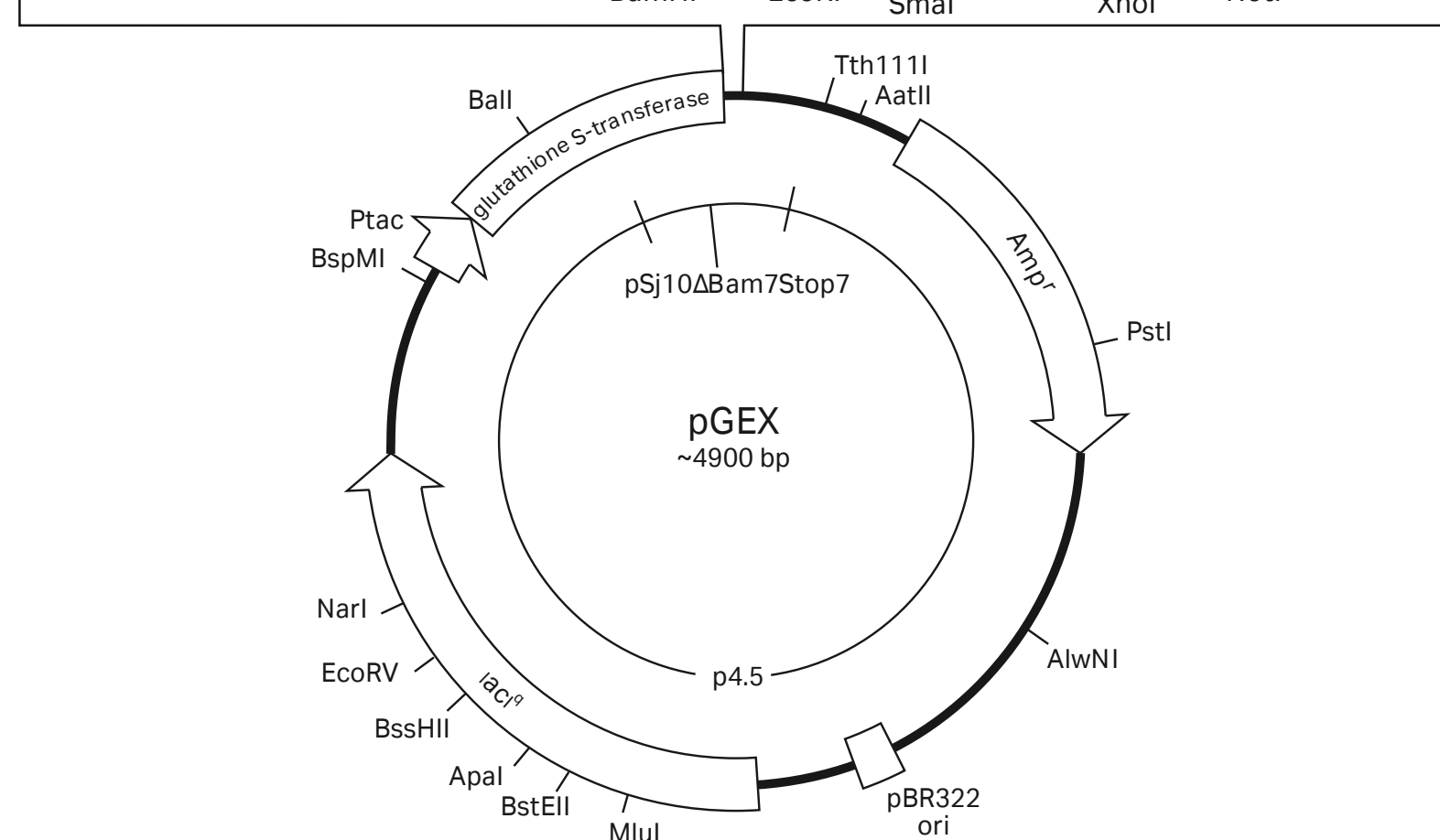
PreScission Protease  
 Leu Glu Val Leu Phe Gln↓Gly Pro Leu Gly Ser Pro Glu Phe Pro Gly Arg Leu Glu Arg Pro His  
 CTG GAA GTT CTG TTC CAG GGG CCC CTG GGA TCC CCG GAA TTC CCG GGT CGA CTC GAG CCG CCG CAT  
 BamHI EcoRI SmaI Sall XhoI NotI

### pGEX-6P-2

PreScission Protease  
 Leu Glu Val Leu Phe Gln↓Gly Pro Leu Gly Ser Pro Gly Ile Pro Gly Ser Thr Arg Ala Ala Ala Ser  
 CTG GAA GTT CTG TTC CAG GGG CCC CTG GGA TCC CCA GGA ATT CCC GGG TCG ACT CGA GCG GCC GCA TCG  
 BamHI EcoRI SmaI Sall XhoI NotI

### pGEX-6P-3

PreScission Protease  
 Leu Glu Val Leu Phe Gln↓Gly Pro Leu Gly Ser Pro Asn Ser Arg Val Asp Ser Ser Gly Arg  
 CTG GAA GTT CTG TTC CAG GGG CCC CTG GGA TCC CCG AAT TCC CGG GTC GAC TCG AGC GGC CGC  
 BamHI EcoRI SmaI Sall XhoI NotI



**Fig A9.1.** Map of the GST vectors showing the reading frames and main features. Complete DNA sequences and restriction site data are available with each individual vector's product information, at [www.cytiva.com](http://www.cytiva.com).

# Appendix 10

## Table of amino acids

Amino acid	Three-letter code	Single-letter code	Structure	Amino acid	Three-letter code	Single-letter code	Structure	Formula	M <sub>r</sub>	Middle unit residue (-H <sub>2</sub> O)		Charge at pH 6.0 to 7.0	Hydrophobic (nonpolar)	Uncharged (polar)	Hydrophilic (polar)
										Formula	M <sub>r</sub>				
Alanine	Ala	A		Methionine	Met	M		C <sub>3</sub> H <sub>7</sub> NO <sub>2</sub>	89.1	C <sub>3</sub> H <sub>5</sub> NO	71.1	Neutral	•		
Arginine	Arg	R		Phenylalanine	Phe	F		C <sub>6</sub> H <sub>14</sub> N <sub>4</sub> O <sub>2</sub>	174.2	C <sub>6</sub> H <sub>12</sub> N <sub>4</sub> O	156.2	Basic (+ve)			•
Asparagine	Asn	N		Proline	Pro	P		C <sub>4</sub> H <sub>7</sub> NO <sub>4</sub>	133.1	C <sub>4</sub> H <sub>5</sub> NO <sub>3</sub>	115.1	Acidic(-ve)			•
Aspartic acid	Asp	D		Serine	Ser	S		C <sub>3</sub> H <sub>7</sub> NO <sub>2</sub> S	121.2	C <sub>3</sub> H <sub>5</sub> NOS	103.2	Neutral		•	
Cysteine	Cys	C		Threonine	Thr	T		C <sub>5</sub> H <sub>9</sub> NO <sub>4</sub>	147.1	C <sub>5</sub> H <sub>7</sub> NO <sub>3</sub>	129.1	Acidic (-ve)			•
Glutamic acid	Glu	E		Tryptophan	Trp	W		C <sub>2</sub> H <sub>5</sub> NO <sub>2</sub>	75.1	C <sub>2</sub> H <sub>3</sub> NO	57.1	Neutral			•
Glutamine	Gln	Q		Tyrosine	Tyr	Y		C <sub>6</sub> H <sub>9</sub> N <sub>3</sub> O <sub>2</sub>	155.2	C <sub>6</sub> H <sub>7</sub> N <sub>3</sub> O	137.2	Basic (+ve)			•
Glycine	Gly	G		Valine	Val	V		C <sub>6</sub> H <sub>13</sub> NO <sub>2</sub>	131.2	C <sub>6</sub> H <sub>11</sub> NO	113.2	Neutral	•		
Histidine	His	H						C <sub>6</sub> H <sub>14</sub> N <sub>2</sub> O <sub>2</sub>	146.2	C <sub>6</sub> H <sub>12</sub> N <sub>2</sub> O	128.2	Basic (+ve)			•
Isoleucine	Ile	I						C <sub>5</sub> H <sub>11</sub> NO <sub>2</sub> S	149.2	C <sub>5</sub> H <sub>9</sub> NOS	131.2	Neutral	•		
Leucine	Leu	L						C <sub>9</sub> H <sub>11</sub> NO <sub>2</sub>	165.2	C <sub>9</sub> H <sub>9</sub> NO	147.2	Neutral	•		
Lysine	Lys	K						C <sub>5</sub> H <sub>9</sub> NO <sub>2</sub>	115.1	C <sub>5</sub> H <sub>7</sub> NO	97.1	Neutral	•		
								C <sub>3</sub> H <sub>7</sub> NO <sub>3</sub>	105.1	C <sub>3</sub> H <sub>5</sub> NO <sub>2</sub>	87.1	Neutral		•	
								C <sub>4</sub> H <sub>9</sub> NO <sub>3</sub>	119.1	C <sub>4</sub> H <sub>7</sub> NO <sub>2</sub>	101.1	Neutral		•	
								C <sub>11</sub> H <sub>12</sub> N <sub>2</sub> O <sub>2</sub>	204.2	C <sub>11</sub> H <sub>10</sub> N <sub>2</sub> O	186.2	Neutral	•		
								C <sub>9</sub> H <sub>11</sub> NO <sub>3</sub>	181.2	C <sub>9</sub> H <sub>9</sub> NO <sub>2</sub>	163.2	Neutral		•	
								C <sub>5</sub> H <sub>11</sub> NO <sub>2</sub>	117.1	C <sub>5</sub> H <sub>9</sub> NO	99.1	Neutral	•		



## Appendix 11

# Principles and standard conditions for different purification techniques

## Affinity chromatography (AC)

AC media separate proteins on the basis of a reversible interaction between a protein (or a group of proteins) and a specific ligand attached to a chromatographic matrix. The technique is well-suited for a capture or as an intermediate purification step and can be used whenever a suitable ligand is available for the protein(s) of interest. AC offers high selectivity and usually high capacity. It is frequently used as the first step (capture step) of a two-step purification protocol, followed by a second chromatographic step (polishing step) to remove remaining impurities.

The target protein(s) is/are specifically and reversibly bound by a complementary binding substance (ligand). The sample is applied under conditions that favor specific binding to the ligand. Unbound material is washed away, and bound target protein is recovered by changing conditions to those favoring elution. Elution is performed specifically, using a competitive ligand, or nonspecifically, by changing the pH, ionic strength, or polarity. Samples are concentrated during binding, and the target protein is collected in purified and concentrated form. The key stages in an AC separation are shown in Figure A11.1. AC is also used to remove specific contaminants; for example, Benzamidine Sepharose 4 Fast Flow (high sub) removes serine proteases.

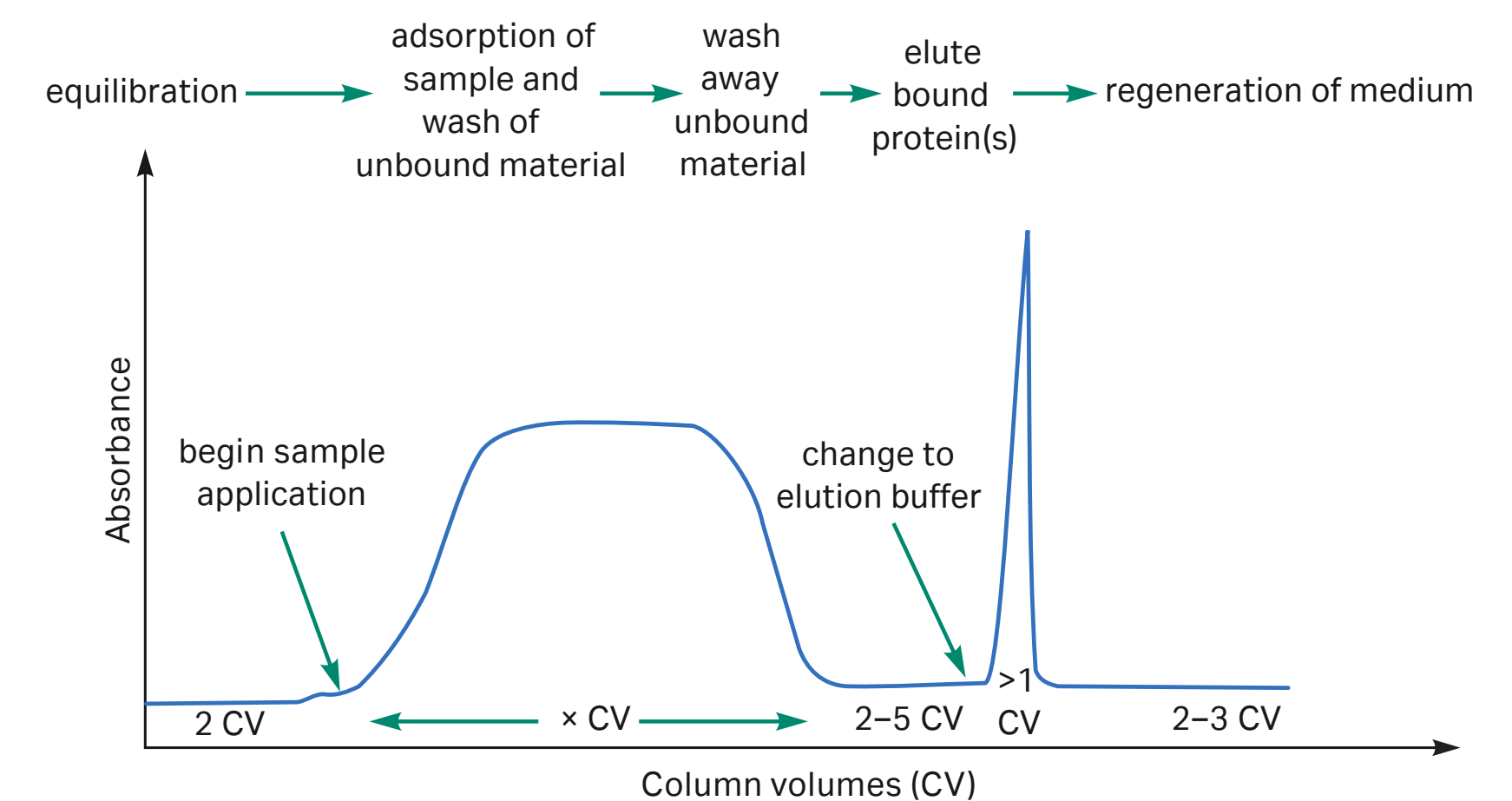
### Further information – Handbooks

*Strategies for Protein Purification*, 28983331

*Purifying Challenging Proteins, Principles and Methods*, 28909531

*Affinity Chromatography, Vol. 1: Antibodies*, 18103746

*Affinity Chromatography, Vol. 3: Specific Groups of Biomolecules*, 18102229

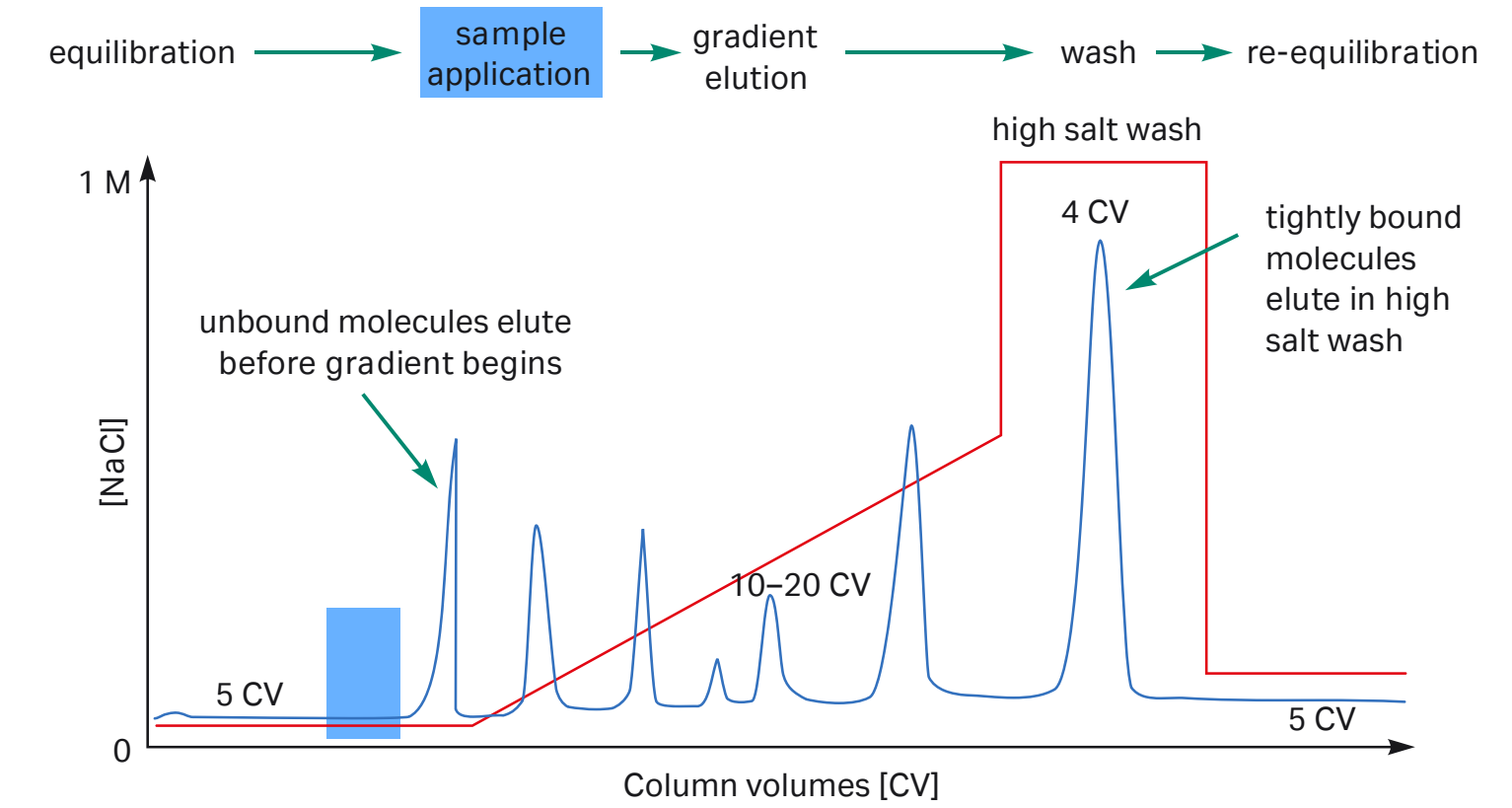


**Fig A11.1.** Typical affinity purification.

## Ion exchange chromatography (IEX)

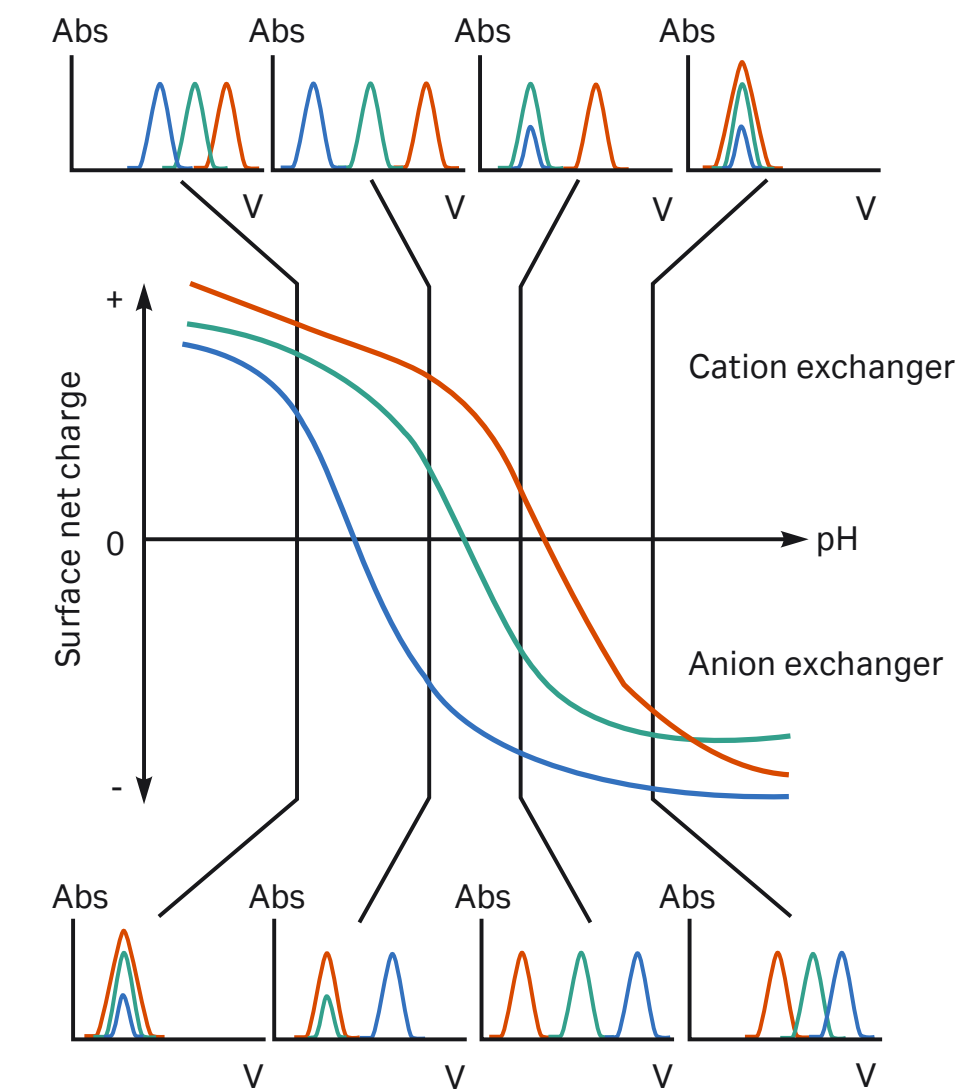
IEX media separate proteins based on differences in surface charge, generating high-resolution separations with high sample loading capacity. The separation is based on the reversible interaction between a charged protein and an oppositely charged chromatography medium. Proteins bind as they are loaded onto a column. Conditions are then altered so that bound substances are eluted differentially. Elution is usually performed by increasing salt concentration or changing pH. Changes are made stepwise or with a continuous linear gradient. Most commonly, samples are eluted with salt (NaCl), using a gradient elution (Fig A11.2). Target proteins are concentrated during binding and collected in a purified, concentrated form.

The net surface charge of proteins varies according to the surrounding pH. Typically, when above its isoelectric point (pI) a protein will bind to an anion exchanger (e.g., Q Sepharose); when below its pI a protein will bind to a cation exchanger (e.g., SP Sepharose). However, it should be noted that binding depends on charge and that surface charges may thus be sufficient for binding even on the other side of the pI. Typically IEX is used to bind the target molecule, but it can also be used to bind impurities if required. IEX can be repeated at different pH values to separate several proteins that have distinctly different charge properties, as shown in Figure A11.3.



**Fig A11.2.** Typical IEX gradient elution. Blue line = absorbance; red line = conductivity (salt concentration).

### Selectivity at different pH of mobile phase

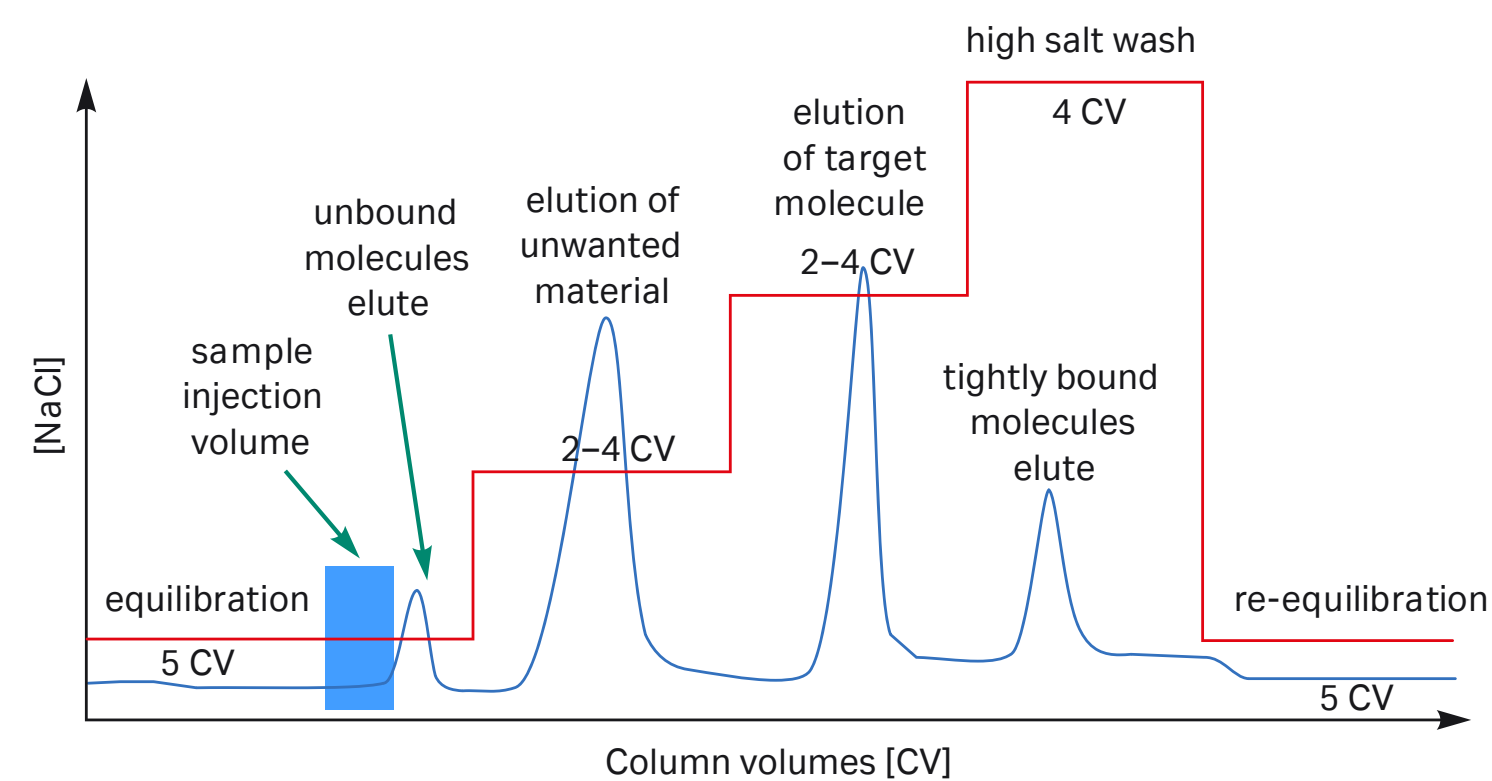


**Fig A11.3.** Effect of pH on protein elution patterns. V = volume.

## Method development (in priority order)

1. Select optimal ion exchanger using small 1 mL columns as in the HiTrap IEX Selection Kit or HiTrap Cpto™ IEX Selection Kit to save time and sample. If a longer packed bed is required use prepacked HiScreen IEX columns. (HiTrap columns have a 2.5 cm bed height, and HiScreen columns have a 10 cm bed height).
2. Scout for optimal pH to maximize capacity and resolution. Begin 0.5 to 1 pH unit away from the isoelectric point of the target protein if known. This optimization step can be combined with optimizing the ionic strength of the sample and binding buffer.
3. Select the steepest gradient to give acceptable resolution at the selected pH. Usually start with a 10 to 20 column volume linear gradient.
4. Select the highest flow rate that maintains resolution and minimizes separation time. Check recommended flow rates for the specific medium and column.

👉 To reduce separation times and buffer consumption, transfer to a step elution after method optimization as shown in Figure A11.4.



**Fig A11.4.** Step elution. Blue line = absorbance; red line = conductivity (salt concentration).

### Further information – Handbooks

*Strategies for Protein Purification*, 28983331

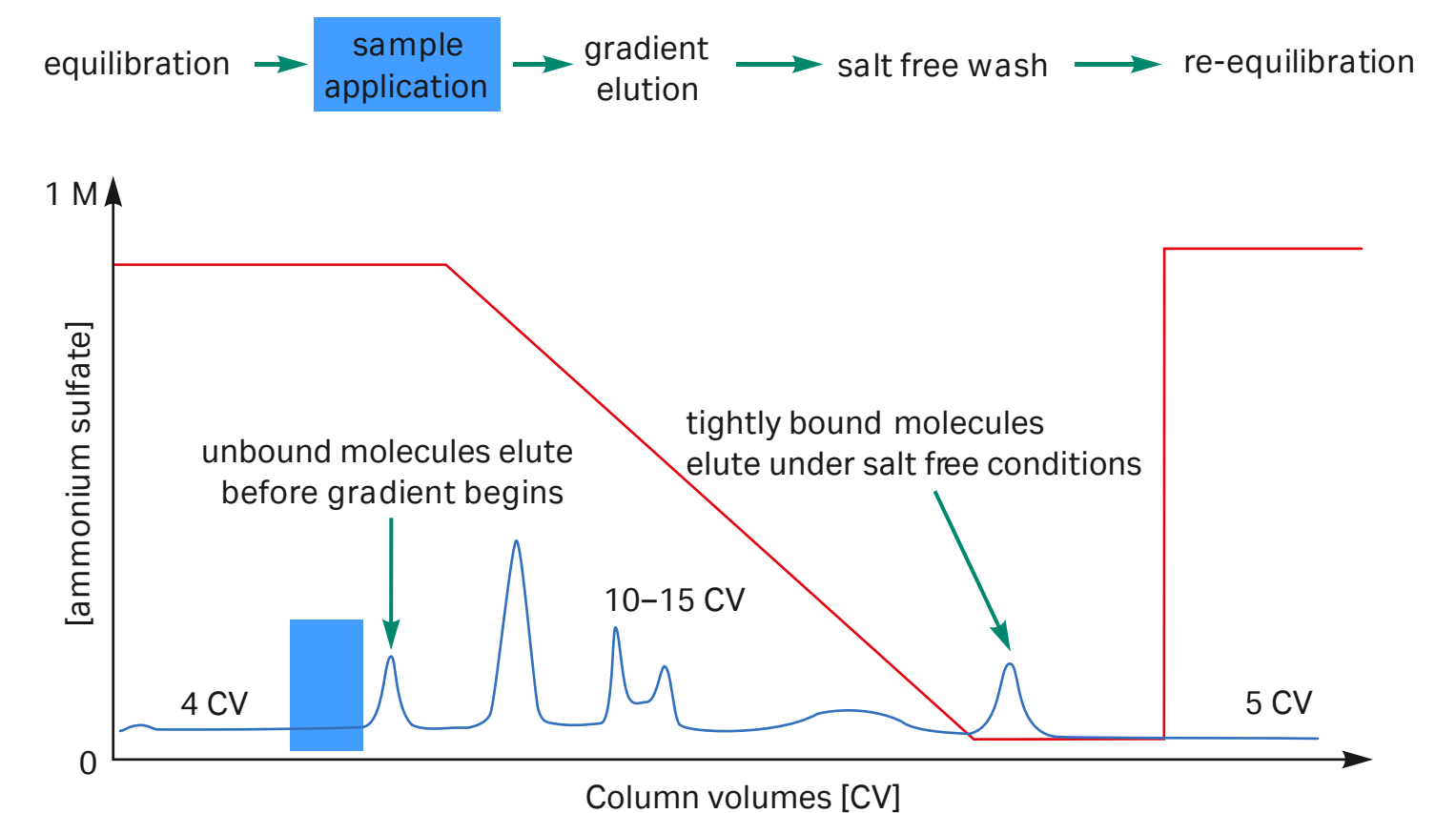
*Purifying Challenging Proteins, Principles and Methods*, 28909531

*Ion Exchange Chromatography, Principles and Methods*, 11000421

## Hydrophobic interaction chromatography (HIC)

HIC media separate proteins with differences in hydrophobicity. The technique is well-suited for the capture or intermediate steps in a purification protocol. Separation is based on the reversible interaction between a protein and the hydrophobic surface of a chromatography medium. This interaction is enhanced by high ionic strength buffer, which makes HIC an excellent “next step” after precipitation with ammonium sulfate or elution in high salt during IEX. Samples in high ionic strength solution (e.g., 1.5 M ammonium sulfate) bind as they are loaded onto a column. Conditions are then altered so that the bound substances are eluted differentially.

Elution is usually performed by decreases in salt concentration (Fig A11.5). Changes are made stepwise or with a continuous decreasing salt gradient. Most commonly, samples are eluted with a decreasing gradient of ammonium sulfate. Target proteins are concentrated during binding and collected in a purified and concentrated form. Other elution procedures include reducing eluent polarity (ethylene glycol gradient up to 50%), adding chaotropic species (urea, Gua HCl), or detergents, changing pH or temperature.




**Fig A11.5.** Typical HIC gradient elution. Blue line = absorbance; red line = conductivity (salt concentration).



## Method development (in priority order)

1. The hydrophobic behavior of a protein is difficult to predict, and binding conditions must be studied carefully. Use HiTrap HIC Selection Kit or RESOURCE HIC Test Kit to select the chromatography medium that gives optimal binding and elution over the required range of salt concentration. For proteins with unknown hydrophobic properties begin with a starting buffer containing, for example, 1 M to 1.5 M ammonium sulfate. Knowledge of the solubility of protein in the binding buffer is important because high concentrations of, for example, ammonium sulfate may precipitate proteins.
2. Select a gradient that gives acceptable resolution. As a starting point, a linear gradient from 0 to 100% B of 10 to 20 column volumes is recommended.
3. Select the highest flow rate that maintains resolution and minimizes separation time. Check recommended flow rates for the specific medium and column.
4. If samples bind strongly to a medium, separation conditions such as pH, temperature, chaotropic ions, or organic solvents may have caused conformational changes and should be altered. Conformational changes are specific to each protein. Use screening procedures to investigate the effects of these agents. Alternatively, change to a less hydrophobic chromatography medium.

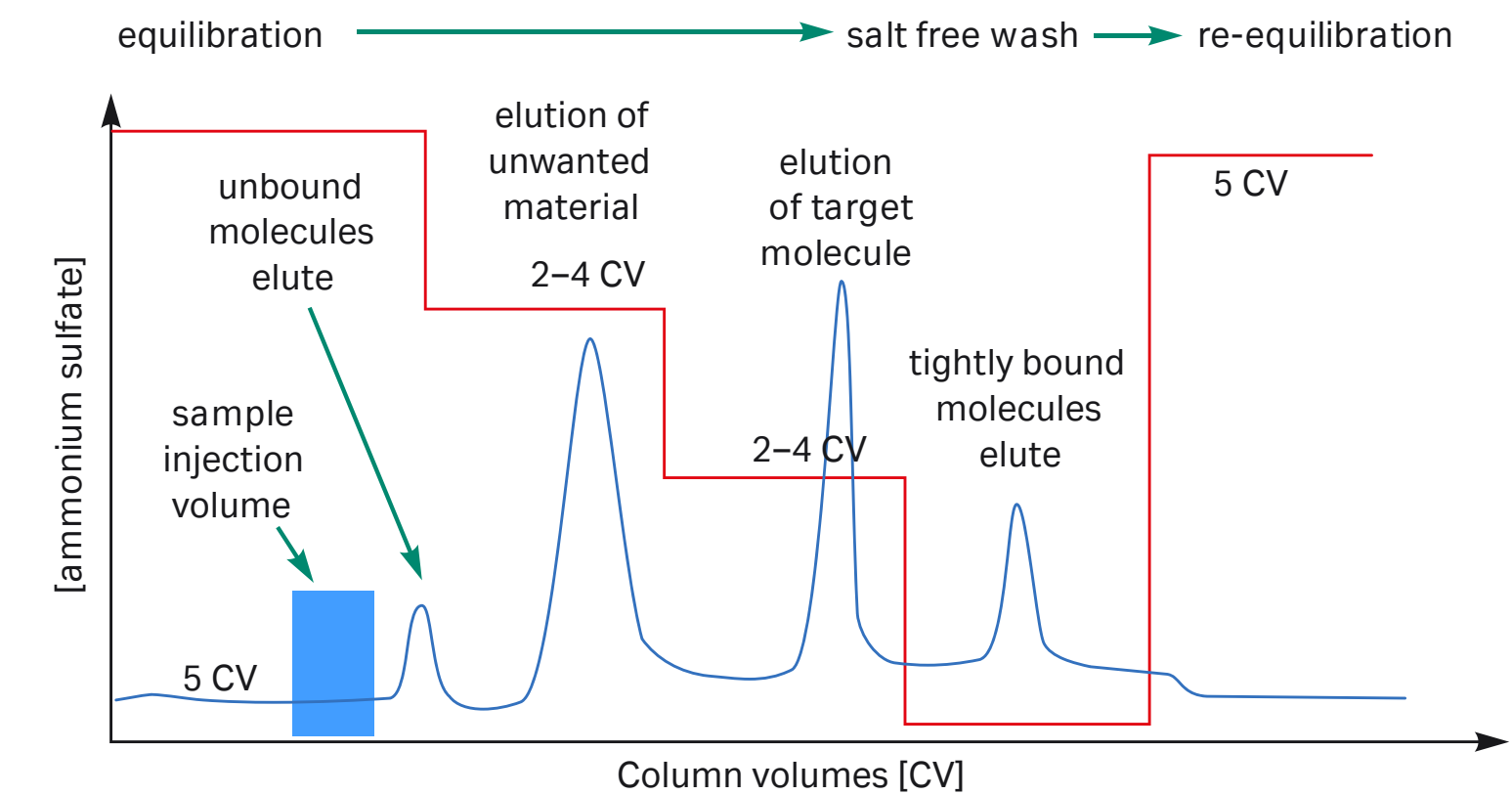
 To reduce separation times and buffer consumption, transfer to a step elution after method optimization, as shown in Figure A11.6.

### Further information – Handbooks

*Strategies for Protein Purification*, 28983331

*Purifying Challenging Proteins, Principles and Methods*, 28909531

*Hydrophobic Interaction and Reversed Phase Chromatography, Principles and Methods*, 11001269



**Fig A11.6.** Step elution. Blue line = absorbance; red line = conductivity (salt concentration).

## Size exclusion chromatography (SEC)

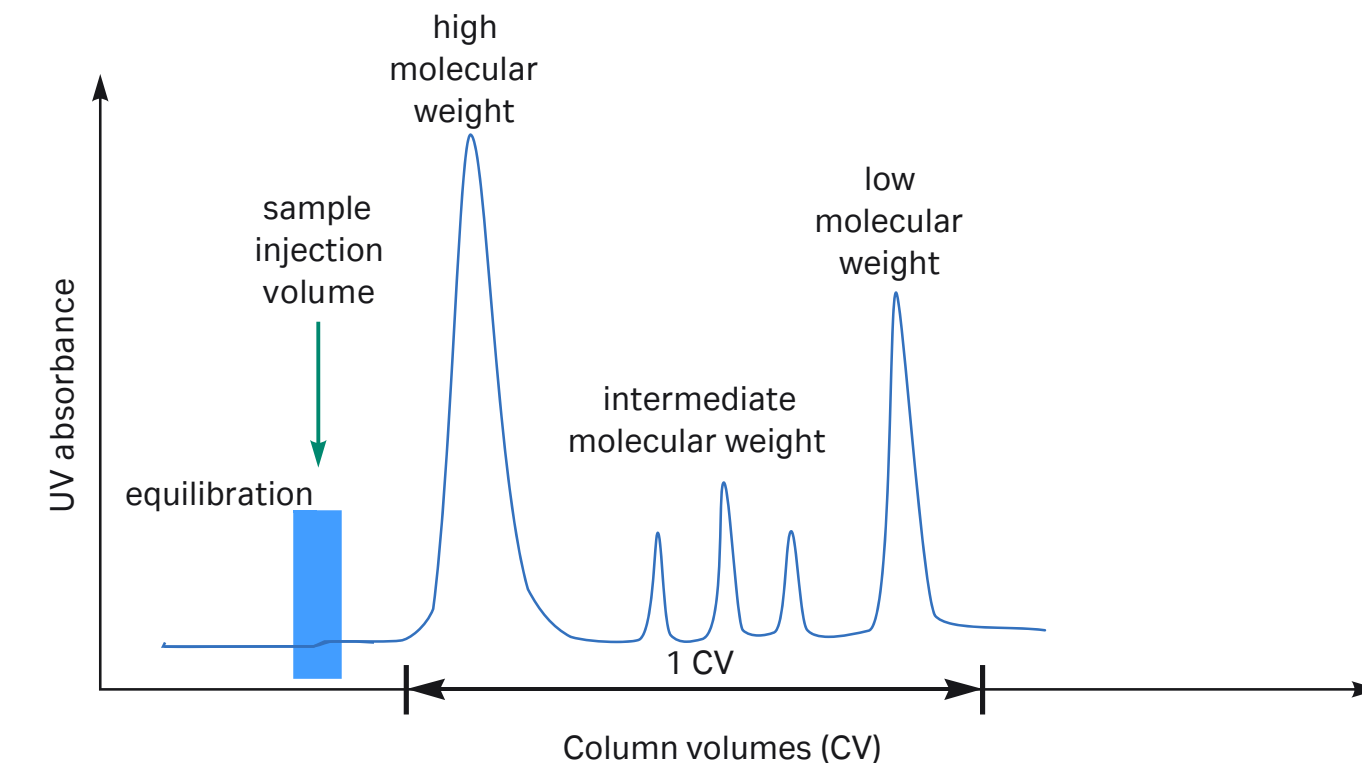
SEC media separate proteins with differences in molecular size and shape. The technique is well-suited for the final polishing steps in purification when sample volumes have been reduced (sample volume significantly influences speed and resolution in SEC). Samples are eluted isocratically (single buffer, no gradient, Fig A11.7). Buffer conditions can be varied to suit the sample type or the requirements for further purification, analysis, or storage, because buffer composition usually does not have major effects on resolution. Proteins are collected in purified form in the chosen buffer.

### Further information — Handbooks

*Strategies for Protein Purification*, 28983331

*Purifying Challenging Proteins, Principles and Methods*, 28909531

*Size Exclusion Chromatography, Principles and Methods*, 18102218



**Fig A11.7.** Typical SEC elution.

## Reversed phase chromatography (RPC)

RPC media separate proteins and peptides with differing hydrophobicity based on their reversible interaction with the hydrophobic surface of a chromatographic medium. Proteins bind as they are loaded onto a column. Conditions are then altered so that the bound substances are eluted differentially. Due to the nature of the reversed phase matrices, binding is usually very strong. Binding may be modulated by the use of organic solvents and other additives (ion pairing agents). Elution is usually performed by increases in organic solvent concentration, most commonly acetonitrile. Samples that are concentrated during the binding and separation process are collected in a purified, concentrated form. The key stages in a separation are shown in Figure A11.8.

- RPC is often used in the final polishing of oligonucleotides and peptides and is well-suited for analytical separations, such as peptide mapping.
- RPC is generally not recommended for protein purification if recovery of activity and return to a correct tertiary structure are required, because many proteins are denatured in the presence of organic solvents. Exceptions exist.

### Method development

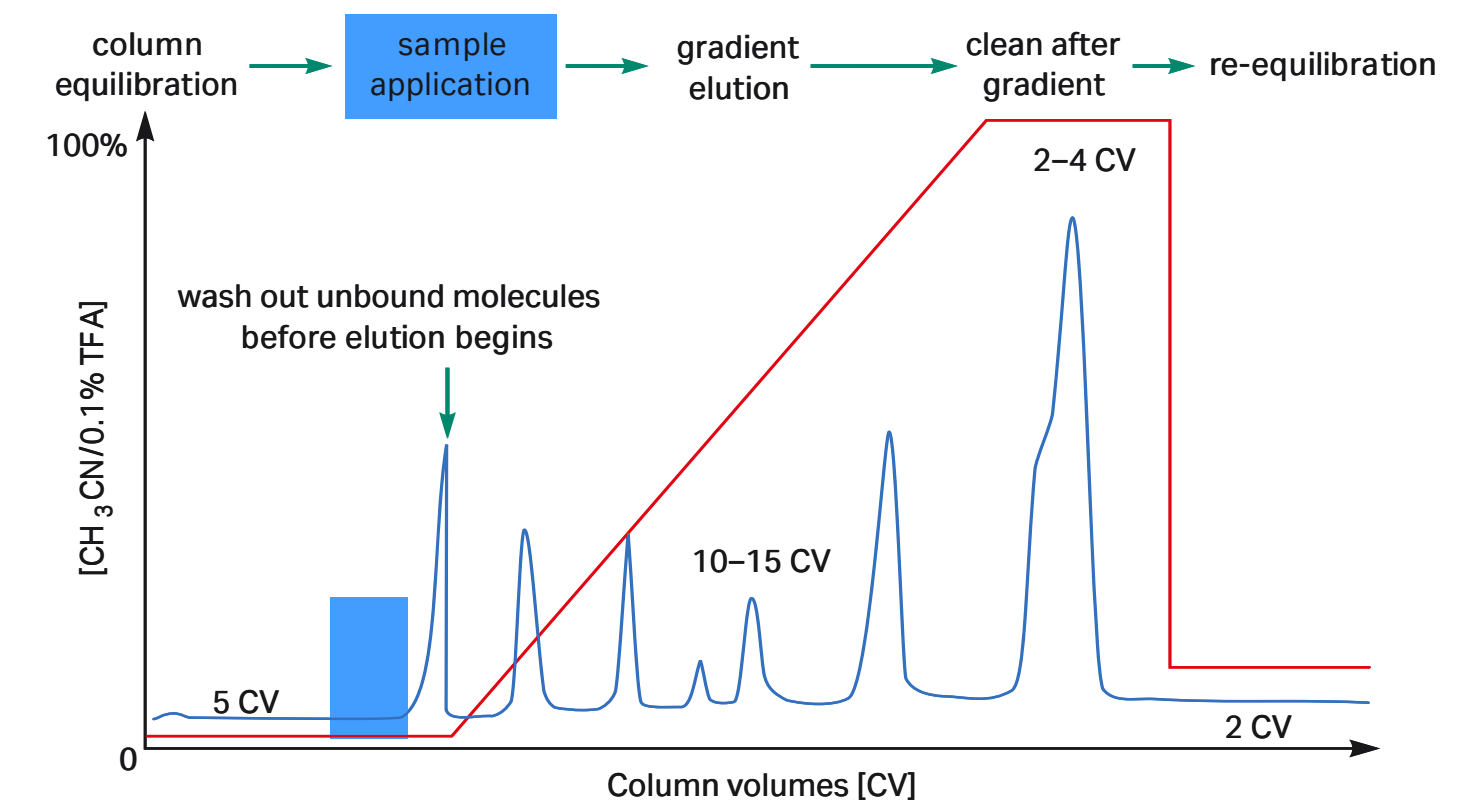
1. Perform a screening and select chromatography medium from the results.
2. Select optimal gradient to give acceptable resolution. As a starting point, a linear gradient from 0 to 100% B of 10 to 20 columns volumes is recommended.
3. Select highest flow rate that maintains resolution and minimizes separation time.
4. For large-scale purification, transfer to a step elution.
5. Proteins that bind strongly to a chromatography medium are more easily eluted by changing to a less hydrophobic chromatography medium.

### Further information — Handbooks

*Strategies for Protein Purification Handbook*, 28983331

*Purifying Challenging Proteins, Principles and Methods*, 28909531

*Hydrophobic Interaction and Reversed Phase Chromatography, Principles and Methods*, 11001269



**Fig A11.8.** Typical RPC gradient elution. Blue line = absorbance; red line = % elution buffer.



## Appendix 12

### Tables for Vivaspin sample concentrators

**Table A12.1.** Maximum sample volumes for different Vivaspin concentrators

Vivaspin	Fixed angle	Swing bucket
500	500 µL	Do not use
2	2 mL	3 mL
6	6 mL	6 mL
20	14 mL	20 mL

**Table A12.2.** Recommended maximum centrifugation speed (× g) for different Vivaspin concentrators

	Vivaspin 500	Vivaspin 2	Vivaspin 6	Vivaspin 20
<b>Fixed angle</b>				
3000-50 000 MWCO	15 000	12 000	10 000	8000
100 000 MWCO	15 000	9000	6000	6000
<b>Swing bucket</b>				
3000-50 000 MWCO	N.A.	4000	4000	5000
100 000 MWCO	N.A.	4000	4000	3000

**Table A12.3.** Performance characteristics of Vivaspin 500

Protein/filter	Up to 30× sample concentration <sup>1</sup>	Recovery
<b>Aprotinin 0.25 mg/mL (6500 MW)</b>		
3000 MWCO	30 min	96%
<b>BSA 1.0 mg/mL (66 000 MW)</b>		
5000 MWCO	15 min	96%
10 000 MWCO	5 min	96%
30 000 MWCO	5 min	95%
<b>IgG 0.25 mg/mL (160 000 MW)</b>		
30 000 MWCO	10 min	96%
50 000 MWCO	10 min	96%
100 000 MWCO	10 min	96%

<sup>1</sup> Centrifugation time to achieve an up to 30× sample concentration with a start volume of 500 µL at 20°C.

**Table A12.4.** Performance characteristics of Vivaspin 2

Protein/filter	Up to 30× sample concentration <sup>1</sup>	Recovery
<b>Aprotinin 0.25 mg/mL (6500 MW)</b>		
3000 MWCO	50 min	96%
<b>BSA 1.0 mg/mL (66 000 MW)</b>		
5000 MWCO	12 min	98%
10 000 MWCO	8 min	98%
30 000 MWCO	8 min	97%
<b>IgG 0.25 mg/mL (160 000 MW)</b>		
30 000 MWCO	10 min	96%
50 000 MWCO	10 min	96%
100 000 MWCO	8 min	95%

<sup>1</sup> Centrifugation time to achieve an up to 30× sample concentration with a start volume of 2 mL at 20°C.

**Table A12.5.** Performance characteristics of Vivaspin 6

Protein/filter	Up to 30× sample concentration <sup>1</sup>			
	Swing bucket	Recovery	25° Fixed angle	Recovery
<b>Cytochrome C 0.25 mg/mL (12 400 MW)</b>				
3000 MWCO	-	-	90 min	97%
<b>BSA 1.0 mg/mL (66 000 MW)</b>				
5000 MWCO	20 min	98%	12 min	98%
10 000 MWCO	13 min	98%	10 min	98%
30 000 MWCO	12 min	98%	9 min	97%
<b>IgG 0.25 mg/mL (160 000 MW)</b>				
30 000 MWCO	18 min	96%	15 min	95%
50 000 MWCO	17 min	96%	14 min	95%
100 000 MWCO	15 min	91%	12 min	91%

<sup>1</sup> Centrifugation time to achieve an up to 30× sample concentration with a start volume of 6 mL at 20°C.

**Table A12.6.** Performance characteristics of Vivaspin 20

Protein/filter	Up to 30× sample concentration <sup>1</sup>			
	Swing bucket	Recovery	25° Fixed angle	Recovery
<b>Cytochrome C 0.25 mg/mL (12 400 MW)</b>				
3000 MWCO	110 min	97%	180 min	96%
<b>BSA 1.0 mg/mL (66 000 MW)</b>				
5000 MWCO	23 min	99%	29 min	99%
10 000 MWCO	16 min	98%	17 min	98%
30 000 MWCO	13 min	98%	15 min	98%
<b>IgG 0.25 mg/mL (160 000 MW)</b>				
30 000 MWCO	27 min	97%	20 min	95%
50 000 MWCO	27 min	96%	22 min	95%
100 000 MWCO	25 min	91%	20 min	90%

<sup>1</sup> Centrifugation time to achieve an up to 30× sample concentration with a start volume of 20 mL (swing bucket rotor) or 14 mL (fixed angle 25° rotor) at 20°C.

# Product index

## Histidine-tagged proteins

### Purification: Ni Sepharose High Performance

Ni Sepharose High Performance	30, 32-33, <b>36-42</b> , 45, 50-53, 118, 120, 191, 210, 231-232, 235
His MultiTrap HP	16, 35-36, 40-41, <b>45</b> , 48, 210, 232
His SpinTrap	27, 36, 40, <b>50-52</b> , 119, 232
His SpinTrap Kit	36, 40, <b>50</b>
HisTrap HP	27, 36, 40, <b>53</b> , 55, 113, 191, 208, 232

### Purification: Ni Sepharose 6 Fast Flow

Ni Sepharose 6 Fast Flow	30, 32, 36, 40, 43-45, 53, 57-58, 62, 67-70, 72, 74, 81, 118, 120, 210, 231-235
His MultiTrap FF	16, 35, 37, 40, 43, <b>45</b> , 48-49, 210, 232
HisTrap FF	27, 37, 40, <b>53</b> , 56, 123, 208, 210, 232-233
HisTrap FF crude	18, 20, 27, 35, 37, 40, 43, <b>57-63</b> , 66, 81, 114-115, 124, 208
HisTrap FF crude Kit	18, 20, 37, 40
His GraviTrap	18, 20, 27, 35, 40, 43, <b>67-69</b> , 85-86, 233
His GraviTrap Kit	37, 40, <b>67</b>
HiScreen Ni FF	37, 40, <b>70</b> , 71, 233
HisPrep FF 16/10	40, 56, <b>72</b> , 234

### Purification: magnetic beads

His Mag Sepharose Ni	27, 33, 37, 40, <b>73</b> , 76, 82, 231-232, 234
His Mag Sepharose excel	27, 32, 38, 73, 76, <b>82</b> , 84, 115, 231, <b>236</b>

### Purification: Ni Sepharose excel

Ni Sepharose excel	12, 30, 32-34, 38-40, <b>76-80</b> , 78-80, 83, 115, 118, 231, <b>236-237</b>
HisTrap excel	27, 35, 38, 76, <b>78-79</b> , 81, 84, 115, 236-237

### Purification: TALON Superflow

TALON Superflow	32-33, 36-38, 76, <b>85-88</b> , 91-93, 95, 115-116, 118, 120, 231, <b>238</b> , 239-240
His MultiTrap TALON	27, 38, 85, <b>88</b> , 90, 239
His SpinTrap TALON	38, 85, <b>91-92</b> , 239
His GraviTrap TALON	27, 38, 85, <b>93-94</b> , 239
HiTrap TALON crude	18, 20, 27, 35, 39, 85-86, <b>95-96</b> , 114-115, 239-240

### Purification: uncharged chromatography media

IMAC Sepharose High Performance	32-33, <b>97-99</b> , 104, 120-122, 241-243
HiTrap IMAC HP	97-98, <b>104-105</b> , 107, 122, 242
IMAC Sepharose 6 Fast Flow	32-33, 97-98, <b>101-102</b> , 104, 108, 110-111, 120-121, 241-243
HiTrap IMAC FF	97-98, <b>104</b> , 110, 121, 242
HiScreen IMAC FF	97-98, <b>108-109</b> , 242
HiPrep IMAC FF 16/10	97-98, <b>110-111</b> , 243

### Companion products for purification

His Buffer Kit	33, 36-37, 39, 50-51, 67, 74, 82, 97
Collection plate (96-well, 500 µL, V-bottom)	<b>129</b>
MagRack 6	27, 73-74, 82
MagRack Maxi	27, 73-74, 82

## GST-tagged proteins

### Protein expression

pGEX vectors	126, <b>129-131</b> , 158
--------------	---------------------------

### Purification: Glutathione Sepharose High Performance

Glutathione Sepharose High Performance	126-128, <b>135</b> , 145-146, 148, 162, 171, 245-246
--	---

GSTrap HP	128, <b>145-148</b> , 167, 246
-----------	--------------------------------

### Purification: Glutathione Sepharose 4 Fast Flow

Glutathione Sepharose 4 Fast Flow	126-128, <b>135</b> , 138, 145, 151, 153, 162, 171, 245-246
-----------------------------------	---

GSTrap FF	27, 127-128, 138, <b>145</b> , 149, 151, 153-154, 162-166, 168-171, 246
-----------	---

GSTPrep FF 16/10	128, 134, 138, 145, <b>151</b> , 153-154, 162, 246
------------------	--

### Purification: Glutathione Sepharose 4B

Glutathione Sepharose 4B	126-128, <b>134-138</b> , 142-145, 162, 171, 245-247
--------------------------	--

GSTrap 4B	27, 128, 138, <b>145</b> , 150, 246
-----------	-------------------------------------

GST GraviTrap	27, 127-128, 138, <b>144</b> , 163, 247
---------------	---

GST Bulk Kit	128
--------------	-----

GST SpinTrap	27, 128, 131, 134, <b>142-143</b> , 162-163, 247
--------------	--

GST MultiTrap 4B	16, 128, 131, 134, <b>138</b> , 246
------------------	-------------------------------------

### Detection

GST Detection Module	129, 134, <b>158</b>
----------------------	----------------------

Anti-GST Antibody	129, 157, 160
-------------------	---------------

Anti-GST HRP Conjugate	129
------------------------	-----

### Enzymes for tag cleavage

Thrombin	129-130, 156-157, 162-165, 168-175, 262
----------	---

Factor Xa	129-130, 156-157, 162-165, 170-175, 262
-----------	---

PreScission Protease	129-130, 156, 162-167, 170-175
----------------------	--------------------------------

### Removal of thrombin and Factor Xa

HiTrap Benzamidine FF (high sub)	129, 162-163, 165, 168-169, 171, 173
----------------------------------	--------------------------------------

Benzamidine Sepharose 4 Fast Flow (high sub)	129, 264
--	----------



**MBP-tagged proteins**

<b>Purification</b>	
Dextrin Sepharose High Performance	177-178, 183, <b>248-249</b>
MBPTrap HP	177, <b>179</b> , 180-184, 249

**Strep-tag II recombinant proteins**

<b>Purification</b>	
StrepTactin Sepharose High Performance	187-188, 192, <b>250-252</b>
StrepTrap HP	187, 188-194, 251-252

**Companion products**

Western blotting detection products	112, 129, 159
HiLoad size exclusion chromatography products	61, 113, 123, 150, 167, 180
ÄKTA chromatography systems	28

**Desalting, buffer exchange, and concentration**

HiTrap Desalting	214-215, 226, 228, 253
HiPrep 26/10 Desalting	113, 124, 213, 215, 228, 253
PD-10 Desalting	213-216, 222-223
PD MiniTrap G-25	213-216, 220-221
PD MidiTrap G-25	213-216, 220-222
PD SpinTrap G-25	213-216, 220
PD MultiTrap G-25	213-218
PD MiniTrap G-10	213-216, 224-225
PD MidiTrap G-10	215-216, 224-225
Vivaspin	214, 217, 219, 221, 223, 229, 270-271

# Related literature

	Code number
<b>Purification handbooks</b>	
Affinity Chromatography, Vol. 1: Antibodies	18103746
Affinity Chromatography, Vol. 2: Tagged Proteins	18114275
Affinity Chromatography, Vol. 3: Specific Groups of Biomolecules	18102229
Ion Exchange Chromatography	11000421
Hydrophobic Interaction and Reversed Phase Chromatography	11001269
Multimodal Chromatography	29054808
Protein Sample Preparation	28988741
Purifying Challenging Proteins	28909531
Size Exclusion Chromatography	18102218
Strategies for Protein Purification	28983331
ÄKTA Laboratory-scale Chromatography Systems	29010831
<b>Selection guides/brochures</b>	
Total solutions for preparation of histidine-tagged proteins, Selection guide	28407092
Glutathione Sepharose — Total solutions for preparation of GST-tagged proteins, Selection guide	28916833
Pure simplicity for tagged proteins, Brochure	28935364
Affinity Columns and Media, Selection guide	18112186
Gel Filtration Columns and Media, Selection guide	18112419
Ion Exchange Columns and Media, Selection guide	18112731
Protein and peptide purification, Technique selection guide	18112863
Prepacked chromatography columns for ÄKTA systems, Selection guide	28931778
Years of experience in every column, Brochure	28909094
Sample preparation for analysis of proteins, peptides and carbohydrates — desalting, buffer exchange, cleanup, concentration, Selection guide	18112862
Protein and nucleic acid sample prep — get it right from the start, Selection guide	28932093

	Code number
<b>Data files and application notes</b>	
Ni Sepharose 6 Fast Flow, HisTrap FF, and HisPrep FF 16/10 columns	11000886
Ni Sepharose High Performance and HisTrap HP columns	18117440
HisTrap FF crude columns and HisTrap FF crude Kit	11001237
His GraviTrap	11003690
His MultiTrap FF and His MultiTrap HP	11003663
His SpinTrap	28404659
His Mag Sepharose Ni	28979723
His Mag Sepharose excel, Ni Sepharose excel, HisTrap excel	29016849
TALON Superflow and prepacked formats	28966410
IMAC Sepharose 6 Fast Flow, HiTrap IMAC FF, and HiPrep IMAC FF 16/10 columns	28404106
IMAC Sepharose High Performance and HiTrap IMAC HP columns	28404105
Flexible purification of histidine-tagged proteins using various metal ions on HiTrap IMAC HP	28409466
Glutathione Sepharose and prepacked columns	28994147
GST MultiTrap 4B	28408157
Addition of imidazole during binding improves purity of histidine-tagged proteins	28406741
Dextrin Sepharose High Performance — MBPTrap HP	28913633
Purification of MBP-tagged proteins using new prepacked columns	28927417
StrepTactin Sepharose High Performance — StrepTrap HP	28913631
Purification of Strep II-tagged proteins using new prepacked columns	28927415
Purification of MBP-tagged and Strep II-tagged proteins	28937200
PD-10 Desalting Columns, PD MidiTrap G-25, PD MiniTrap G-25, PD SpinTrap G-25, and PD MultiTrap G-25	28926748
PD MiniTrap G-10, PD MidiTrap G-10	28926749
Vivaspin	28935653

# Ordering information

Product	Quantity	Code number
<b>Histidine-tagged proteins</b>		
<b>Purification</b>		
Ni Sepharose High Performance	25 mL	17526801
	100 mL*	17526802
HisTrap HP	5 × 1 mL	17524701
	100 × 1 mL <sup>†</sup>	17524705
	1 × 5 mL	17524801
	5 × 5 mL	17524802
	100 × 5 mL <sup>†</sup>	17524805
His MultiTrap HP	4 × 96-well filter plates	28400989
His SpinTrap	50 × 100 µL	28401353
His SpinTrap Kit	1 kit	28932171
Ni Sepharose 6 Fast Flow	5 mL	17531806
	25 mL	17531801
	100 mL	17531802
	500 mL*	17531803
HisTrap FF	5 × 1 mL	17531901
	100 × 1 mL <sup>†</sup>	17531902
	5 × 5 mL	17525501
	100 × 5 mL <sup>†</sup>	17525502
HisTrap FF crude	5 × 1 mL	11000458
	100 × 1 mL <sup>†</sup>	11000459
	5 × 5 mL	17528601
	100 × 5 mL <sup>†</sup>	17528602
HisTrap FF crude Kit	3 × 1 mL, buffers	28401477
HisPrep FF 16/10	1 × 20 mL	28936551
His MultiTrap FF	4 × 96-well filter plates	28400990

Product	Quantity	Code number
His GraviTrap	10 × 1 mL	11003399
His GraviTrap Kit	20 × 1 mL, buffers	28401351
HiScreen Ni FF	1 × 4.7 mL	28978244
His Mag Sepharose Ni	2 × 1 mL 5% medium slurry	28967388
	5 × 1 mL 5% medium slurry	28967390
	10 × 1 mL 5% medium slurry	28979917
Ni Sepharose excel	25 mL	17371201
	100 mL	17371202
	500 mL	17371203
HisTrap excel	5 × 1 mL	17371205
	5 × 5 mL	17371206
His Mag Sepharose excel	2 × 1 mL	17371220
	5 × 1 mL	17371221
	10 × 1 mL	17371222
HiTrap TALON crude	5 × 1 mL	28953766
	100 × 1 mL <sup>†</sup>	28953805
	5 × 5 mL	28953767
	100 × 5 mL <sup>†</sup>	28953809
TALON Superflow	10 mL	28957499
	50 mL	28957502
His SpinTrap TALON	50 × 0.1 mL	29000593
His GraviTrap TALON	10 × 1 mL	29000594
His MultiTrap TALON	4 × 96-well plates	29000596
IMAC Sepharose High Performance	25 mL	17092006
	100 mL*	17092007
HiTrap IMAC HP	5 × 1 mL	17092003
	5 × 5 mL	17092005

Product	Quantity	Code number
IMAC Sepharose 6 Fast Flow	25 mL	17092107
	100 mL*	17092108
HiTrap IMAC FF	5 × 1 mL	17092102
	5 × 5 mL	17092104
HiPrep IMAC FF 16/10	1 × 20 mL	28936552
HiScreen IMAC FF	1 × 4.7 mL	28950517
His Buffer Kit	1 kit	11003400
HiTrap Chelating HP	5 × 1 mL	17040801
	1 × 5 mL	17040901
	5 × 5 mL	17040903
	100 × 5 mL <sup>†</sup>	17040905
Chelating Sepharose Fast Flow	50 mL	17057501
	500 mL*	17057502

## GST-tagged proteins

### Protein expression

pGEX-4T-1	25 µg	28954549
pGEX-4T-2	25 µg	28954550
pGEX-4T-3	25 µg	28954552
pGEX-5X-1	25 µg	28954553
pGEX-5X-2	25 µg	28954554
pGEX-5X-3	25 µg	28954555
pGEX-2TK	25 µg	28954646
pGEX-6P-1	25 µg	28954648
pGEX-6P-2	25 µg	28954650
pGEX-6P-3	25 µg	28954651

\* Larger quantities are available; please contact Cytiva.

† Special pack size delivered on specific customer order.



Product	Quantity	Code number
pGEX-2T	25 µg	28954653
pGEX-3X	25 µg	28954654
pGEX -1λT EcoRI/BAP	5 µg	28954656

#### Purification

Glutathione Sepharose High Performance	25 mL	17057901
	100 mL*	17057902

GSTrap HP	5 × 1 mL	17528101
	100 × 1 mL <sup>†</sup>	17528105
	1 × 5 mL	17528201
	5 × 5 mL	17528202
	100 × 5 mL <sup>†</sup>	17528205

Glutathione Sepharose 4 Fast Flow	25 mL	17513201
	100 mL	17513202
	500 mL*	17513203

GSTrap FF	2 × 1 mL	17513002
	5 × 1 mL	17513001
	100 × 1 mL <sup>†</sup>	17513005
	1 × 5 mL	17513101
	5 × 5 mL	17513102
	100 × 5 mL <sup>†</sup>	17513105

GSTPrep FF 16/10	1 × 20 mL	28936550
------------------	-----------	----------

Glutathione Sepharose 4B	10 mL	17075601
	100 mL	17075605
	300 mL*	17075604

GSTrap 4B	5 × 1 mL	28401745
	100 × 1 mL <sup>†</sup>	28401746
	1 × 5 mL	28401747
	5 × 5 mL	28401748
	100 × 5 mL <sup>†</sup>	28401749

GST GraviTrap	10 × 2 mL	28952360
---------------	-----------	----------

GST SpinTrap	50 × 50 µL	28952359
--------------	------------	----------

Product	Quantity	Code number
GST MultiTrap 4B	4 × 96-well filter plates	28405500
GST Bulk Kit	1 kit	27457001

#### Detection

GST Detection Module	50 detections	27459001
----------------------	---------------	----------

Anti-GST Antibody	0.5 mL, 50 detections	27457701
-------------------	-----------------------	----------

Anti-GST HRP Conjugate	75 µL	RPN1236
------------------------	-------	---------

#### Tag cleavage

#### Enzymes

Thrombin	500 units	27084601
----------	-----------	----------

Factor Xa	400 units	27084901
-----------	-----------	----------

PreScission Protease	500 units	27084301
----------------------	-----------	----------

#### Removal of thrombin and Factor Xa

HiTrap Benzamidine FF (high sub)	2 × 1 mL	17514302
----------------------------------	----------	----------

	5 × 1 mL	17514301
--	----------	----------

	1 × 5 mL	17514401
--	----------	----------

Benzamidine Sepharose 4 Fast Flow (high sub)	25 mL*	17512310
--	--------	----------

#### MBP-tagged proteins

#### Purification

Dextrin Sepharose High Performance	25 mL	28935597
	100 mL	28935598

MBPTrap HP	5 × 1 mL	28918778
	1 × 5 mL	28918779
	5 × 5 mL	28918780

#### Strep-tag II recombinant proteins

#### Purification

StrepTactin Sepharose High Performance	10 mL	28935599
	50 mL	28935600

Product	Quantity	Code number
StrepTrap HP	5 × 1 mL	28907546
	1 × 5 mL	28907547
	5 × 5 mL	28907548

#### Companion product

<i>E. coli</i> BL21	1 vial	27154201
---------------------	--------	----------

#### Western blotting membranes, antibodies, and detection reagents

Amersham Protran 0.45 (300 mm × 4 m)	1 roll	10600002
--------------------------------------	--------	----------

Amersham Protran 0.2 (200 × 200 mm)	25 sheets	10600043
-------------------------------------	-----------	----------

Amersham Protran 0.1 (100 × 100 mm)	10 sheets	10600077
-------------------------------------	-----------	----------

Amersham Protran Premium 0.45 (80 × 90 mm)	25 sheet	10600096
--	----------	----------

Amersham Protran Premium 0.2 (140 × 160 mm)	25 sheet	10600066
---	----------	----------

Amersham Protran Supported 0.45 (200 mm × 4 m)	1 roll	10600036
--	--------	----------

Amersham Protran Supported 0.2 (150 mm × 4 m)	1 roll	10600054
---	--------	----------

Amersham Hybond 0.45 PVDF (300 × 600 mm)	5 sheets	10600038
--	----------	----------

Amersham Hybond 0.2 PVDF (260 × 600 mm)	5 sheets	10600039
---	----------	----------

Amersham Hybond LFP 0.2 (100 × 100 mm)	25 sheets	10600090
--	-----------	----------

Amersham Hybond SEQ 0.2 (200 × 200 mm)	10 sheets	10600061
--	-----------	----------

Amersham Hybond LFP Sandwich (140 × 160 mm)	10 sandwiches	10600112
---	---------------	----------

Amersham Protran Premium 0.2 Sandwich (80 × 90 mm)	10 sandwiches	10600118
--	---------------	----------

ECL Western Blotting Anti-GST HRP Conjugate	75 µL	RPN1236
---	-------	---------

Amersham ECL Plex Western Blotting Combination Pack (incl. Cy3, Cy5, Amersham Protran Premium 0.45)	for 1000 cm <sup>2</sup>	RPN998
---	--------------------------	--------

Amersham ECL Plex Western Blotting Combination Pack (incl. Cy3, Cy5, Amersham Hybond LFP)	for 1000 cm <sup>2</sup>	RPN999
---	--------------------------	--------

Amersham ECL Western Blotting Detection Reagents	for 1000 cm <sup>2</sup>	RPN2109
--	--------------------------	---------

Amersham ECL Prime Western Blotting Detection Reagent	for 1000 cm <sup>2</sup>	RPN2232
---	--------------------------	---------

Amersham ECL Select Western Blotting Detection Reagent	for 1000 cm <sup>2</sup>	RPN2235
--	--------------------------	---------

--	--	--

--	--	--

--	--	--

--	--	--

--	--	--

--	--	--

--	--	--

--	--	--

--	--	--

--	--	--

\* Larger quantities are available; please contact Cytiva.

† Special pack size delivered on specific customer order.

Product	Quantity	Code number
<b>Desalting, buffer exchange, and concentration</b>		
HiTrap Desalting	5 × 5 mL	17140801
	100 × 5 mL <sup>†</sup>	11000329
HiPrep 26/10 Desalting	1 × 53 mL	17508701
	4 × 53 mL	17508702
PD-10 Desalting columns	30	17085101
PD SpinTrap G-25	50	28918004
PD MultiTrap G-25	4 × 96-well filter plates	28918006
PD MiniTrap G-25	50	28918007
PD MidiTrap G-25	50	28918008
PD MiniTrap G-10	50	28918010
PD MidiTrap G-10	50	28918011
Vivaspin 500 MWCO 3000	25	28932218
Vivaspin 500 MWCO 5000	25	28932223
Vivaspin 500 MWCO 10 000	25	28932225
Vivaspin 500 MWCO 30 000	25	28932235
Vivaspin 500 MWCO 50 000	25	28932236
Vivaspin 500 MWCO 100 000	25	28932237
Vivaspin 2 MWCO 3000	25	28932240
Vivaspin 2 MWCO 5000	25	28932245
Vivaspin 2 MWCO 10 000	25	28932247
Vivaspin 2 MWCO 30 000	25	28932248
Vivaspin 2 MWCO 50 000	25	28932257
Vivaspin 2 MWCO 100 000	25	28932258
Vivaspin 6 MWCO 3000	25	28932293
Vivaspin 6 MWCO 5000	25	28932294
Vivaspin 6 MWCO 10 000	25	28932296
Vivaspin 6 MWCO 30 000	25	28932317
Vivaspin 6 MWCO 50 000	25	28932318
Vivaspin 6 MWCO 100 000	25	28932319

<sup>†</sup> Special pack size delivered on specific customer order.

Product	Quantity	Code number
Vivaspin 20 MWCO 3000	12	28932358
Vivaspin 20 MWCO 5000	12	28932359
Vivaspin 20 MWCO 10 000	12	28932360
Vivaspin 20 MWCO 30 000	12	28932361
Vivaspin 20 MWCO 50 000	12	28932362
Vivaspin 20 MWCO 100 000	12	28932363

### Size exclusion chromatography

HiLoad 16/600 Superdex 30 pg	1 × 120 mL	28989331
HiLoad 26/600 Superdex 30 pg	1 × 320 mL	28989332
HiLoad 16/600 Superdex 75 pg	1 × 120 mL	28989333
HiLoad 26/600 Superdex 75 pg	1 × 320 mL	28989334
HiLoad 16/600 Superdex 200 pg	1 × 120 mL	28989335
HiLoad 26/600 Superdex 200 pg	1 × 320 mL	28989336
HiPrep 16/60 Sephacryl™ S-100 HR	1 × 120 mL	17116501
HiPrep 26/60 Sephacryl S-100 HR	1 × 320 mL	17119401
HiPrep 16/60 Sephacryl S-200 HR	1 × 120 mL	17116601
HiPrep 26/60 Sephacryl S-200 HR	1 × 320 mL	17119501
HiPrep 16/60 Sephacryl S-300 HR	1 × 120 mL	17116701
HiPrep 26/60 Sephacryl S-300 HR	1 × 320 mL	17119601
HiPrep 16/60 Sephacryl S-400 HR	1 × 120 mL	28935604
HiPrep 26/60 Sephacryl S-400 HR	1 × 320 mL	28935605
HiPrep 16/60 Sephacryl S-500 HR	1 × 120 mL	28935606
HiPrep 26/60 Sephacryl S-500 HR	1 × 320 mL	28935607

### Empty columns

Complete information on the range of Tricorn columns is available at [www.cytiva.com/protein-purification](http://www.cytiva.com/protein-purification)

Tricorn 5/20 column	1	28406408
Tricorn 5/50 column	1	28406409
Tricorn 10/20 column	1	28406413
Tricorn 10/50 column	1	28406414
Tricorn 10/100 column	1	28406415

Product	Quantity	Code number
Tricorn columns are delivered with a column tube, adapter unit, end cap, a filter kit containing adapter and bottom filters and O-rings, two stop plugs, two fingertight fittings, adapter lock and filter holder, and two M6 connectors, if required.		
XK 16/20 column	1	28988937
XK 16/40 column	1	28988938
XK 26/20 column	1	28988948
XK 26/40 column	1	28988949
XK 50/20 column	1	28988952
XK 50/30 column	1	28988953

XK columns are delivered with one AK adapter, TEFZEL tubing (0.8 mm i.d. for XK 16 and XK 26 columns, 1.2 mm i.d. for XK 50 columns, with M6 connectors, thermostatic jacket, support snap-on net rings, dismantling tool (XK 16 and XK 26 only), and instructions.

HiScale 16/20 column	1	28964441
HiScale 16/40 column	1	28964424
HiScale 26/20 column	1	28964514
HiScale 26/40 column	1	28964513
HiScale 50/20 column	1	28964445
HiScale 50/40 column	1	28964444
HR 16/5 column	1	18100098
HR 16/10 column	1	19740301
HR 16/50 column	1	18146001

HR columns are delivered with a column tube, adapter unit, end cap, a filter kit containing adapter and bottom filters and O-rings and M6 male fittings.

Empty PD-10 Desalting columns	50	17043501
-------------------------------	----	----------

### Accessories and spare parts

For a complete listing refer to [www.cytiva.com/protein-purification](http://www.cytiva.com/protein-purification)

LabMate PD-10 Buffer Reservoir	10	18321603
Collection plate (96-well, 500 µL, V-bottom)	5	28403943
MagRack 6	1	28948964
MagRack Maxi	1	28986441
Packing Connector XK 16	1	18115344
Packing Connector XK 26	1	18115345

Product	Quantity	Code number
Tricorn packing equipment 10/100	1	18115325
Tricorn packing equipment 10/100 includes Tricorn packing connector 10-10, Tricorn 10/100 glass tube, bottom unit and stop plug.		
Tricorn packing connector 10-10 <sup>‡</sup>	1	18115323
Connects extra glass column to a Tricorn 10 column to act as a packing reservoir for efficient packing.		
1/16" male/Luer female <sup>‡</sup>	2	18111251
Tubing connector flangeless/M6 female <sup>‡</sup>	2	18100368
Tubing connector flangeless/M6 male <sup>‡</sup>	2	18101798
Union 1/16" female/M6 male <sup>‡</sup>	6	18111257
Union M6 female /1/16" male	5	18385801
Union Luerlock female/M6 female	2	18102712
HiTrap/HiPrep, 1/16" male connector for ÄKTA systems	8	28401081
Stop plug female, 1/16" <sup>§</sup>	5	11000464
Fingertight stop plug, 1/16" <sup>¶</sup>	5	11000355

<sup>‡</sup> One connector included in each HiTrap package.

<sup>§</sup> Two, five, or seven female stop plugs included in HiTrap packages, depending on products.

<sup>¶</sup> One fingertight stop plug is connected to the top of each HiTrap column.



## cytiva.com

Cytiva and the Drop logo are trademarks of Global Life Sciences IP Holdco LLC or an affiliate. Amersham, ÄKTA, Biacore, Capto, ECL, ECL Plex, ECL Select, ExcelGel, GraviTrap, GSTPrep, GSTrap, HiLoad, HiPrep, HiScale, HiScreen, HisPrep, HisTrap, HiTrap, Hybond, ImageQuant, MabSelect, MabSelect SuRe, MabSelect Xtra, MBPTrap, MidiTrap, MiniTrap, Mono Q, MultiPhor, MultiTrap, PhastGel, PhastSystem, PreScission, PrimeView, Protran, Rainbow, RESOURCE, Sephacryl, Sephadex, Sepharose, SpinTrap, SOURCE, StrepTrap, Superdex, Superloop, Tricorn, and UNICORN are trademarks of Global Life Sciences Solutions USA LLC or an affiliate doing business as Cytiva.

AcTev, BCA, Coomassie, GIBCO, High Five, HisProbe, Novex and SimplyBlue are trademarks of Thermo Fisher Scientific. Benzonase, BugBuster and Milli-Q are trademarks of Merck KGaA. CYMAL is a trademark of Anatrace Products, LLC. Eppendorf is a trademark of Eppendorf AG. EX-CELL and SAFC are trademarks of Sigma-Aldrich Co. Gel Doc is a trademark of Bio-Rad Laboratories Inc. GenBank is a trademark of US Dept. of Health & Human Services. Kathon is a trademark of Dow Chemical Co. Pefabloc is a trademark of DSM IP Assets B.V. Tween is a trademark of Croda Group of Companies. *Strep*-Tactin and *Strep*-tag are trademarks of IBA GmbH. Superflow is a trademark of Sterogene Bioseparations Inc. Triton is a trademark of Union Carbide Chemicals and Plastics Company, Inc. Vibracell is a trademark of Sonics & Materials, Inc. Vivaspin is a trademark of Sartorius Stedim Biotech GmbH. All other third-party trademarks are the property of their respective owners.

ECL Prime: This product or portions thereof is manufactured and sold under license from Cyanagen Srl and is subject of US patent 7,855,287, US Patent 7,803,573, and US Patent 9,040,252, together with other equivalent granted patents and patent applications in other countries.

IMAC Sepharose products, Ni Sepharose products and Fe Sepharose products: These products are sold under a license from Sigma-Aldrich under patent number EP 1276716 (Metal chelating compositions) and equivalent patents and patent applications in other countries.

TALON Superflow and HiTrap TALON: TALON is a registered trademark of Clontech Laboratories Inc.

© 2021 Cytiva

All goods and services are sold subject to the terms and conditions of sale of the supplying company operating within the Cytiva business. A copy of those terms and conditions is available on request. Contact your local Cytiva representative for the most current information.

For local office contact information, visit [cytiva.com/contact](https://www.cytiva.com/contact)

CY13980-26Jan21-HB

